

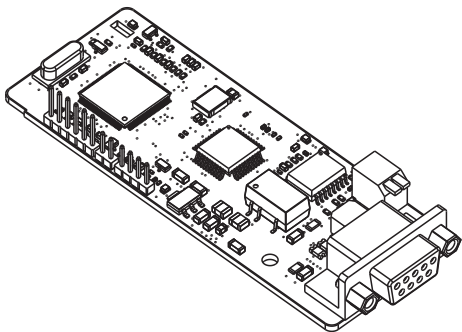

# Operation **Manual** **Goodrive350 Series VFD** **Communication Extension Card**





## Safety precautions

The extension card can be installed and operated only by people who have taken part in professional training on electrical operation and safety knowledge, obtained the certification, and been familiar with all steps and requirements for installing, performing commissioning on, operating, and maintaining the device, and are capable of preventing all kinds of emergencies.

Before installing, removing, or operating the communication card, read the safety precautions described in this manual and the variable-frequency drive (VFD) operation manual carefully to ensure safe operation.

For any physical injuries or damage to the device caused due to your neglect of the safety precautions described in this manual and the VFD operation manual, our company shall not be held liable.

- You need to open the housing of the VFD when installing or removing the communication card. Therefore, you must disconnect all power supplies of the VFD and ensure that the voltage inside the VFD is safe. For details, see the description in the VFD operation manual. Severe physical injuries or even death may be caused if you do not follow the instructions.
- Store the communication card in a place that is dustproof and dampproof without electric shocks or mechanical pressure.
- The communication card is electrostatic sensitive. Take measurements to prevent electrostatic discharge when performing operations involving it.
- Tighten the screws up when installing the communication card. Ensure that it is firmly fixed and properly grounded.

**Terminology and abbreviations**

CAN	Controller Area Network
COB	Communication object, a transmitted unit on a CAN network. Communication objects (COBs) carry data and can be transmitted through the whole network. A COB is part of a CAN message frame.
EDS	Electronic datasheet, an ASCII file for node configuration, required when a CANopen network is configured. An EDS file contains general information about nodes and their dictionary objects (parameters).
NMT	Network management, one of the CAN application-layer service elements in the CAN reference model. It is used for the initialization, configuration, and fault handling of a CAN network.
Object dictionary	Stores information about all COBs identified by a device.
PDO	Process data object, a type of COBs, used to transmit process data, such as control command, set values, state values, and actual values.
PDO <sub>n</sub> Tx	PDO command transmitted by a slave station to the master station, where n refers to 1, 2, 3, 4.
PDO <sub>n</sub> Rx	PDO command transmitted by the master station and received by a slave station, where n refers to 1, 2, 3, 4.
SDO	Service data object, a type of COB, used to transmit non-time key data, such as parameter values.
RO	Indicates read-only access.
RW	Indicates the read and write access.
SYNC	Indicates synchronous transmission.
Node-ID	Node ID, that is, address of a communication card.
0x	Indicates that a number with this prefix is a hexadecimal value, for example, 0x10 indicates the decimal value 16.

# Contents

<b>Contents</b> .....	<b>1</b>
<b>Chapter 1 Product confirmation</b> .....	<b>1</b>
<b>Chapter 2 PROFIBUS communication card</b> .....	<b>2</b>
2.1 Overview .....	2
2.2 Features .....	2
2.3 Electrical connection .....	3
2.4 Bus network connection .....	3
2.5 System configuration .....	6
2.6 PROFIBUS-DP communication .....	7
<b>Chapter 3 CANopen communication card</b> .....	<b>17</b>
3.1 Overview .....	17
3.2 Features .....	17
3.3 Electrical wiring .....	18
3.4 Communication .....	19
3.4.1 Packet format .....	19
3.4.2 CANopen state transition .....	20
3.4.3 Management service command (NMT) .....	21
3.4.4 Node protection (NMT Node Guarding) .....	22
3.4.5 Heartbeat packet (Heartbeat Producer) .....	23
3.4.6 Start packet (NMT Boot-up) .....	23
3.4.7 Synchronous packet object (SYNC) .....	24
3.4.8 Emergency packet object (EMCY) .....	24
3.4.9 Service data object (SDO) .....	26
3.5 Process data object (PDO) .....	29
3.5.1 Triggering mode of PDO Tx .....	30
3.5.2 PDO1 .....	31
3.5.3 PDO2 Rx .....	34
3.5.4 PDO2 Tx .....	36
3.5.5 PDO3 Rx and PDO4 Rx .....	37
3.5.6 PDO3 Tx and PDO4 Tx .....	38
3.6 Monitoring process data through SDO commands .....	38
3.7 Baud rate and communication address setting .....	41
3.7.1 Baud rate setting .....	41
3.7.2 Communication address setting .....	42
3.7.3 Function codes related to transmitted and received PZD .....	42
<b>Chapter 4 PROFINET communication card</b> .....	<b>45</b>
4.1 Overview .....	45
4.2 Features .....	45
4.3 Electrical wiring .....	47

4.4 Communication.....	48
4.4.1 Packet format.....	48
4.4.2 PROFINET I/O communication.....	49
<b>Chapter 5 EtherNet/IP communication card .....</b>	<b>56</b>
5.1 Overview.....	56
5.2 Features.....	56
5.3 Electrical wiring.....	58
5.4 Communication.....	59
5.4.1 Communication settings .....	59
5.4.2 Packet format.....	59
5.4.3 EtherNet/IP communication .....	60
5.4.4 Communication with the PLC .....	68
<b>Chapter 6 EtherCAT communication card .....</b>	<b>80</b>
6.1 Overview.....	80
6.2 Features.....	80
6.3 Electrical wiring.....	82
6.4 Communication.....	83
6.4.1 CoE reference model.....	83
6.4.2 EtherCAT slave station information .....	84
6.4.3 EtherCAT state machine.....	84
6.4.4 PDO mapping .....	85
6.4.5 DC-based network synchronization .....	86
6.5 CiA402 device protocol.....	86
6.5.1 CoE state machine .....	87
6.5.2 Device running mode.....	90
6.6 Function code modification.....	92
6.7 Example for TwinCAT2 application .....	93
<b>Appendix A CANopen object dictionary.....</b>	<b>100</b>
<b>Appendix B EtherCAT object dictionary .....</b>	<b>107</b>
<b>Appendix C Related function codes .....</b>	<b>115</b>

## Chapter 1 Product confirmation

Check the following after receiving a communication extension card product:

- Whether the communication card is damaged.
- Whether the received communication card is the one you purchase according to the bar code label on the PCB.
- Whether all the following items are contained in the product package:
- One communication card, one tie wrap, one tie, one M3 screw, and one manual.
- If the communication card is damaged, a wrong model is delivered, or some items are missing, contact the supplier in a timely manner.
- Obtain the ESD file of the communication card from INVT. The file is named *communication card model.eds*.
- Confirm the environmental requirements for application.

Table 1-1 Environmental requirements

Item	Requirement
Operation temperature	-10—+50°C
Storage temperature	-20—+60°C
Relative humidity	5%–95%
Other weather conditions	No condensation, ice, rain, snow, or hail; solar radiation < 700 W/m <sup>2</sup>
Air pressure	70–106 kPa
Vibration and impact	5.9m/s <sup>2</sup> (0.6g) at the sine vibration of 9 Hz to 200 Hz

## Chapter 2 PROFIBUS communication card

### 2.1 Overview

PROFIBUS communication cards are optional accessories for VFDs. They can be used to connect VFDs to PROFIBUS networks. On a PROFIBUS network, VFDs are slave devices. The following functions can be performed by using a PROFIBUS communication card:

- Transmit control commands (such as start, stop, and fault reset) to a VFD.
- Transmit speed or torque reference signals to a VFD.
- Obtain state values and actual values from a VFD.
- Modify parameter values of a VFD.

### 2.2 Features

1. PROFIBUS is an international open fieldbus standard that can implement data exchange between various automation components. It is widely applicable to automation in various industries, such as the manufacturing, process, building, transportation, and power industries. It provides effective solutions for implementing integrated automation and intelligentization of field devices.
2. PROFIBUS consists of three mutually compatible components, namely PROFIBUS-Decentralised Peripherals (DP), PROFIBUS-Process Automation (PA), and PROFIBUS-Fieldbus Message Specification (FMS). It adopts the master-slave mode and is generally used for periodic data exchange between VFD devices. PRNV PROFIBUS-DP adapter modules support only the PROFIBUS-DP protocol.
3. The transmission media of a PROFIBUS field bus are twisted pairs (complying with the RS-485 standard), paired cables, or optical cables. The baud rate ranges from 9.6 kbit/s to 12 Mbit/s. The maximum length of a fieldbus cable must be within the range of 100 m to 1200 m, and the specific length depends on the selected transmission rate (see the chapter of "Technical Data" in the VFD manual). A maximum of 31 nodes can be connected to one PROFIBUS network segment when no repeater is used. If repeaters are used, a maximum of 127 nodes (including the repeaters and master stations) can be connected.
4. In PROFIBUS communication, tokens are transmitted between master stations or by master stations to slave stations. Single-master or multi-master systems are supported. The node to respond to the command of a master is selected by the master station, generally a programmable logic controller (PLC). For cyclic master-slave user data transmission and non-cyclic master-master data transmission, a master can also transmit commands to multiple nodes in broadcast mode. When the broadcast mode is adopted, the nodes do not need to transmit feedback signals to the master. On PROFIBUS networks, nodes cannot communicate with each other.

5. The PROFIBUS protocol is described in details in the EN50170 standard. For more information about PROFIBUS, refer to the EN50170 standard.

## 2.3 Electrical connection

1. Node selection

The node address of a device is unique on a PROFIBUS bus. The node address is set through the function parameter P15.01, and the value ranges from 0 to 127.

2. Fieldbus terminator

Each fieldbus segment is configured with two bus terminators, one on each end, to prevent operation errors. Bus terminators can protect the fieldbus signal against electrical reflections. The dual in-line package (DIP) switch on the printed circuit board (PCB) of a communication card is used to connect to the fieldbus terminator. If the communication card is the last or first module on the network, the bus terminator must be set to ON. When a PROFIBUS D-sub connector with a built-in terminator is used, you must disconnect the communication card from the terminator.

## 2.4 Bus network connection

1. Bus communication interfaces

The most common PROFIBUS transmission mode is the shielded twisted-pair copper cable transmission, in which shielded twisted-pair copper cables (complying with the RS-485 standard) are used.

The basic characteristics of this transmission technology are described as follows:

- Network topology: Linear bus with one active fieldbus terminal resistor on each end
- Transmission rate: 9.6 kbit/s–12 Mbit/s
- Media: Shielded or unshielded twisted-pair cables, depending on the EMC environmental conditions
- Number of stations: 32 on each network segment (without repeater); a maximum of 127 (with repeaters)
- Plug connection: 9-pin D-type plug. The following figure shows the pins of the connector.

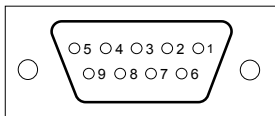

Figure 2-1 Plug of the connector



Table 2-1 Connector pins

Connector pin		Description
1	-	Unused
2	-	Unused
3	B-Line	Data+ (twisted-pair wire 1)
4	RTS	Transmitting requests
5	GND_BUS	Isolation ground
6	+5V_BUS	Isolated 5 V DC power supply
7	-	Unused
8	A-Line	Data- (twisted-pair wire 2)
9	-	Unused
Housing	SHLD	PROFIBUS cable shielding wire

The +5V and GND\_BUS pins are used for bus terminators. Optical transceivers (RS-485) and some other devices may need to obtain external power supplies through these pins.

For some devices, the transmission direction is determined by using the RTS pin. In regular application, only the A-Line, B-Line, and SHLD pins are used.

It is recommended that you use the standard DB9 connectors manufactured by Siemens. If the communication baud rate is required to be higher than 187.5 kbps, strictly follow the wiring standards stipulated by Siemens.

## 2. Repeaters

A maximum of 32 stations (including the master station) can be connected to each fieldbus segment. If the number of stations to be connected to a fieldbus segment exceeds 32, you need to use repeaters to connect the fieldbus segments. Generally, the number of repeaters connected in series cannot exceed 3.

**Note:** No station address is provided for repeaters, but they are calculated as stations.

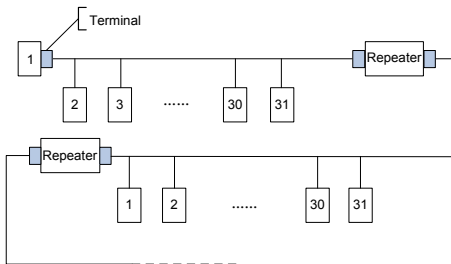

Figure 2-2 Repeaters

### 3. Transmission rates and maximum transmission distances

The maximum length of a cable depends on the transmission rate. Table 2-2 describes the transmission rates and corresponding transmission distances.

Table 2-2 Transmission rates and corresponding transmission distances

Transmission rate (kbps)	A-type wire (m)	B-type wire (m)
9.6	1200	1200
19.2	1200	1200
93.75	1200	1200
187.5	1000	600
500	400	200
1500	200	-----
12000	100	-----

Table 2-3 Transmission wire parameters

Parameter	A-type wire	B-type wire
Impedance ( $\Omega$ )	135–165	100–130
Capacitance of a unit length (pF/m)	< 30	< 60
Circuit resistance ( $\Omega$ /km)	110	-----
Wire core diameter (mm)	0.64	> 0.53
Sectional area of wire core (mm <sup>2</sup> )	> 0.34	> 0.22

Besides the shielded twisted-pair copper cables, you can also use optical fibers for transmission in a PROFIBUS system. When a PROFIBUS system is applied in an environment with strong electromagnetic interference, you can use optical fiber conductors to increase the high-speed transmission distance. Two types of optical fiber conductors can be used. One is low-cost plastic fiber conductors that can be used when the transmission distance is shorter than 50 m; and the other is glass fiber conductors that can be used when the transmission distance is shorter than 1 km.

### 4. PROFIBUS bus connection diagram

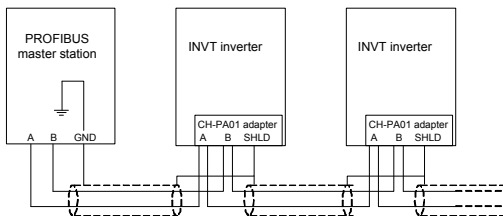

Figure 2-3 PROFIBUS bus connection

Figure 2-3 shows the terminal wiring. The cables are standard PROFIBUS cables, each consisting of a twisted pair and shielding layer. The shielding layers of PROFIBUS cables are directly grounded on all nodes. You can select a proper grounding mode based on the actual situation on site.

**Note:**

1. When connecting the stations, ensure that the data cables are not twisted together. For systems to be used in environments with strong electromagnetic radiation, you need to use cables with shielding layers. The shielding layers can improve electromagnetic compatibility (EMC).
2. If shielding braid or shielding foil is used, connect the two ends of it to the protective ground and cover an area as large as possible to ensure high conductivity. In addition, data cables need to be separated from high-voltage cables.
3. When the data transmission rate is higher than 500 kbit/s, do not use short stub. Use the plugs available in the market. Data input and output cables can be directly connected to those plugs, and the plug of the communication card can be connected or disconnected at any time without interrupting data communication of other stations.

## 2.5 System configuration

### 1. System configuration

After the communication card is properly installed, you need to configure the master station and VFD to enable the communication between the master station and communication card.

One device description file named GSD file is required for each PROFIBUS slave station on the PROFIBUS bus. The GSD file is used to describe the characteristics of the PROFIBUS-DP device. The software we provide for users includes information about the GSD file of the VFD. You can obtain the type definition files (GSD files) of various masters from INVT.

Table 2-4 Communication card configuration parameters

Parameter No.	Parameter name	Setting options	Default setting
0	Module type	Read-only	PROFIBUS-DP
1	Node address	0-99	2
2	Baud rate setting	kbit/s	6
		0: 9.6	
		1: 19.2	
		2: 45.45	
		3: 93.75	
		4: 187.5	

Parameter No.	Parameter name	Setting options	Default setting
		5: 500	
		6: 1.5	
		7: 3	
		8: 6	
		9: 9	
		10: 12	
3	PZD3	0–65535	0
4	PZD4	0–65535	0
...	...	0–65535	0
10	PZD12	0–65535	0

## 2. Module type

This parameter displays the model of the communication card detected by the VFD. You cannot modify the value of this parameter. If the parameter is not defined, communication between the communication card and VFD cannot be established.

## 3. Node address

On the PROFIBUS network, each device corresponds to one unique node address. The node address is set through P15.01.

## 4. GSD file

One device description file named GSD file is required for each PROFIBUS slave station on the PROFIBUS bus. The GSD file is used to describe the characteristics of the PROFIBUS-DP device. The GSD file includes all parameters defined for the device, including the supported baud rate, supported information length, input/output data amount, and definitions of diagnosis data.

You can obtain the type definition files (GSD files) of various masters from INVT's official website and copy the GSD files to the corresponding subdirectories on the configuration tool software. For details about the operation and how to configure the PROFIBUS system, see the instructions for the related system configuration software.

## 2.6 PROFIBUS-DP communication

### 1. PROFIBUS-DP

PROFIBUS-DP is a distributed input/output (I/O) system. It enables a master to use a large number of peripheral modules and on-site devices. Data transmission is periodic: The master reads information input by a slave and transmits a feedback signal to the slave.

### 2. SAP

The PROFIBUS-DP system uses the services at the data link layer (Layer 2) through service access points (SAPs). Functions of each SAP are clearly defined. For more information about SAPs, see the related PROFIBUS master user manuals, that is, PROFIdrive—PROFIBUS models or EN50170 standards (PROFIBUS protocol) for variable-speed drives.

### 3. PROFIBUS-DP information frame data structure

The PROFIBUS-DP system allows fast data exchange between the master and VFD devices. For VFD devices, data is always read and written in the master/slave mode. VFDs always function as slave stations, and one address is clearly defined for each slave station. PROFIBUS transmits 16-bit packets periodically. Figure 2-4 shows the structure of the packet.

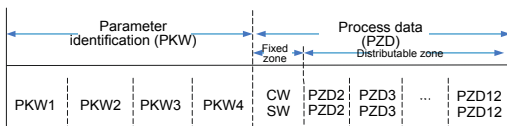

Figure 2-4 PROFIBUS-DP information frame data structure

Parameter zone:

PKW1—Parameter identification

PKW2—Array index number

PKW3—Parameter value 1

PKW4—Parameter value 2

Process data:

CW—Control word (transmitted from the master to a slave. For description, see Table 2-5)

SW—State word (transmitted from a slave to the master. For description, see Table 2-7.)

PZD—Process data (defined by users)

(When the process data is output by the master to a slave, it is a reference value; and when the process data is input by a slave to the master, it is an actual value.)

**PZD zone (process data zone):** The PZD zone in a communication packet is designed for controlling and monitoring a VFD. The master and slave stations always process the received PZD with the highest priority. The processing of PZD takes priority over that of PKW, and the master and slave stations always transmit the latest valid data on the interfaces.

**CWs and SWs**

Using CWs is the basic method of the fieldbus system to control VFDs. A CW is transmitted by

the fieldbus master station to a VFD device. In this case, the EC-TX-103 communication card functions as a gateway. The VFD device responds to the bit code information of the CW and feeds state information back to the master through an SW.

Reference value: A VFD device may receive control information in multiple channels, including analog and digital input terminals, VFD control panel, and communication modules (such as RS485 and EC-TX-103 communication cards). To enable the control over VFD devices through PROFIBUS, you need to set the communication module as the controller of the VFD device.

Actual value: An actual value is a 16-bit word that includes information about VFD device operation. The monitoring function is defined through VFD parameters. The conversion scale of an integer transmitted as an actual value from the VFD device to the master depends on the set function. For more description, see the related VFD operation manual.

**Note:** A VFD device always checks the bytes of a CW and reference value.

Task packet (master station -> VFD)

CW: The first word in a PZD task packet is a VFD CW. Table 2-5 describes Goodrive350 series VFD CWs.

Table 2-5 Goodrive350 series VFD CWs

Bit	Name	Value	State to be entered/description
0-7	Communication-based control command	1	Forward running
		2	Reverse running
		3	Forward jogging
		4	Reverse jogging
		5	Decelerating to stop
		6	Coasting to stop (emergency stop)
		7	Fault reset
		8	Jogging stopped
8	Enabling writing	1	Enabling writing (mainly through PKW1 to PKW4)
9-10	Motor group setting	00	Motor 1
		01	Motor 2
11	Control mode switching	1	Enabling the switching between torque control and speed control
		0	No switching
12	Resetting power consumption to zero	1	Enabling the function for resetting power consumption to zero
		0	Disabling the function for resetting power

Bit	Name	Value	State to be entered/description
			consumption to zero
13	Pre-excitation	1	Enabling pre-excitation
		0	Disabling pre-excitation
14	DC braking	1	Enabling DC braking
		0	Disabling DC braking
15	Heartbeat reference	1	Enabling heartbeat
		0	Disabling heartbeat

Reference value (REF): The second to twelfth words in a PZD task packet are the main settings. The main frequency settings are provided by the main setting signal source. Table 2-6 describes the settings of Goodrive350 series VFD.

Table 2-6 Settings of Goodrive350 series VFD

Function code	Word	Value range	Default value
P15.02	Received PZD2	0: Invalid 1: Set frequency (0–Fmax, unit: 0.01 Hz)	0
P15.03	Received PZD3	2: PID reference (0–1000, in which 1000 corresponds to 100.0%) 3: PID feedback (0–1000, in which 1000 corresponds to 100.0%)	0
P15.04	Received PZD4	4: Torque setting (-3000–+3000, in which 1000 corresponds to 100.0% of the rated current of the motor)	0
P15.05	Received PZD5	5: Setting of the upper limit of forward running frequency (0–Fmax, unit: 0.01 Hz) 6: Setting of the upper limit of reverse running frequency (0–Fmax, unit: 0.01 Hz)	0
P15.06	Received PZD6	7: Upper limit of the electromotive torque (0–3000, in which 1000 corresponds to 100.0% of the rated current of the motor)	0
P15.07	Received PZD7	8: Upper limit of the brake torque (0–3000, in which 1000 corresponds to 100.0% of the rated current of the motor)	0
P15.08	Received PZD8	9: Virtual input terminal command, 0x000–0x3FF (corresponding to S8, S7, S6, S5, HDIB, HDIA, S4, S3, S2, and S1 in sequence)	0
P15.09	Received PZD9	10: Virtual output terminal command, 0x00–0x0F (corresponding to RO2, RO1, HDO, and Y1 in sequence)	0
P15.10	Received PZD10	11: Voltage setting (for V/F separation)	0

Function code	Word	Value range	Default value
	PZD12	(0–1000, in which 1000 corresponds to 100.0% of the rated voltage of the motor) 12: AO output setting 1 (-1000–+1000, in which 1000 corresponds to 100.0%) 13: AO output setting 2 (-1000–+1000, in which 1000 corresponds to 100.0%) 14: MSB of position reference (signed number) 15: LSB of position reference (unsigned number) 16: MSB of position feedback (signed number) 17: LSB of position feedback (unsigned number) 18: Position feedback setting flag (position feedback can be set only after this flag is set to 1 and then to 0)	

Response packet (VFD -> master station)

SW: The first word in a PZD response packet is a VFD SW. Table 2-7 describes the VFD SWs.

Table 2-7 Goodrive350 series VFD SWs

Bit	Name	Value	State to be entered/description
0–7	Running state	1	In forward running
		2	In reverse running
		3	Stopped
		4	Faulty
		5	POFF
		6	In pre-excitation
8	Bus voltage established	1	Ready to run
		0	Not ready to run
9–10	Motor group feedback	0	Motor 1
		1	Motor 2
11	Motor type feedback	1	Synchronous motor
		0	Asynchronous motor
12	Overload pre-alarm feedback	1	Overload pre-alarm generated
		0	No overload pre-alarm generated
13	Run/Stop mode	0	Keypad-based control
		1	Terminal-based control
		2	Communication-based control
14		3	Reserved
15	Heartbeat feedback	1	Heartbeat feedback
		0	No heartbeat feedback

Actual value (ACT): The second to twelfth words in a PZD task packet are the main actual



values. The main actual frequency values are provided by the main actual value signal source.

Table 2-8 Actual state values of Goodrive350 series VFD

Function code	Word	Value range	Default value
P15.13	Transmitted PZD2	0: Invalid	0
P15.14	Transmitted PZD3	1: Running frequency ( $\times 100$ , Hz)	0
P15.15	Transmitted PZD4	2: Set frequency ( $\times 100$ , Hz)	0
P15.16	Transmitted PZD5	3: Bus voltage ( $\times 10$ , V)	0
P15.17	Transmitted PZD6	4: Output voltage ( $\times 1$ , V)	0
P15.18	Transmitted PZD7	5: Output current ( $\times 10$ , A)	0
P15.19	Transmitted PZD8	6: Actual output torque ( $\times 10$ , %)	0
P15.20	Transmitted PZD9	7: Actual output power ( $\times 10$ , %)	0
P15.21	Transmitted PZD10	8: Rotating speed of the running ( $\times 1$ , RPM)	0
P15.22	Transmitted PZD11	9: Linear speed of the running ( $\times 1$ , m/s)	0
P15.23	Transmitted PZD12	10: Ramp frequency reference 11: Fault code 12: AI1 value ( $\times 100$ , V) 13: AI2 value ( $\times 100$ , V) 14: AI3 value ( $\times 100$ , V) 15: HDIA frequency ( $\times 100$ , kHz) 16: Terminal input state 17: Terminal output state 18: PID reference ( $\times 100$ , %) 19: PID feedback ( $\times 100$ , %) 20: Rated torque of the motor 21: MSB of position reference (signed number) 22: LSB of position reference (unsigned number) 23: MSB of position feedback (signed number) 24: LSB of position feedback (unsigned number) 25: State word 2 26: HDIB frequency value ( $\times 100$ , kHz)	0

PKW zone (parameter identification flag PKW1—numerical zone): The PKW zone describes the processing mode of the parameter identification interface. A PKW interface is not a physical interface but a mechanism that defines the transmission mode (such reading and

writing a parameter value) of a parameter between two communication ends.

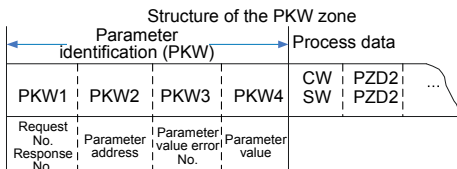

Figure 2-5 Parameter identification zone

In the periodic PROFIBUS-DP communication, the PKW zone consists of four 16-bit words. Table 2-9 describes each word in the PKW zone.

Table 2-9 Each word in the PKW zone

First word PKW 1 (16 bits)		
Bits 15–00	Task or response identification flag	0–7
Second word PKW2 (16 bits)		
Bits 15–00	Basic parameter address	0–247
Third word PKW3 (16 bits)		
Bits 15–00	Value (most significant word) of a parameter or error code of the returned value	00
Fourth word PKW4 (16 bits)		
Bits 15–00	Value (least significant word) of a parameter	0–65535

**Note:** If the master station requests the value of a parameter, the values in PKW3 and PKW4 of the packet that the master station transmits to the VFD are no longer valid.

**Task request and response:** When transmitting data to a slave, the master uses a request number, and the slave uses a response number to accept or reject the request. Table 2-10 describes the request and response functions.

Table 2-10 Task identification flag PKW1

Request No. (from the master to a slave)		Response signal	
Request No.	Function	Acceptance	Rejection
0	No task	0	–
1	Requesting the value of a parameter	1, 2	3
2	Modifying a parameter value (one word) [modifying the value only on RAM]	1	3 or 4
3	Modifying a parameter value (two words) [modifying the value only on RAM]	2	3 or 4
4	Modifying a parameter value (one word) [modifying the value on both RAM and EEPROM]	1	3 or 4
5	Modifying a parameter value (two words) [modifying the value only on both RAM and EEPROM]	2	3 or 4

The requests #2, #3, and #5 are not supported currently.

Table 2-11 Response identification flag PKW1

Response No. (from a slave to the master)	
Response No.	Function
0	No response
1	Transmitting the value of a parameter (one word)
2	Transmitting the value of a parameter (two words)
3	The task cannot be executed and one of the following error number is returned: 1: Invalid command 2: Invalid data address 3: Invalid data value 4: Operation failure 5: Password error 6: Data frame error 7: Parameter read only 8: Parameter cannot be modified during VFD running 9: Password protection

#### PKW examples

Example 1: Reading the value of a parameter

You can set PKW1 to 1 and PKW2 to 10 to read a frequency set through keypad (the address

of the frequency set through keypad is 10), and the value is returned in PKW4.

Request (master station -> VFD)

	PKW1		PKW2		PKW3		PKW4		CW		PZD2		PZD3		...	PZD12	
Request	00	01	00	10	00	00	00	00	xx	xx	xx	xx	xx	xx	...	xx	xx

0001: Requesting to read a parameter value

0010: Parameter address

Response (VFD -> master station)

	PKW1		PKW2		PKW3		PKW4		CW		PZD2		PZD3		...	PZD12	
Response	00	01	00	10	00	00	50	00	xx	xx	xx	xx	xx	xx	...	xx	xx

5000: Parameter value in address 10

0001: Response (parameter value updated)

Example 2: Modifying the value of a parameter (on both RAM and EEPROM)

You can set PKW1 to 4 and PKW2 to 10 to modify a frequency set through keypad (the address of the frequency set through keypad is 10), and the value to be modified (50.00) is in PKW4.

Request (master station -> VFD)

	PKW1		PKW2		PKW3		PKW4		CW		PZD2		PZD3		...	PZD12	
Request	00	04	00	10	00	00	50	00	xx	xx	xx	xx	xx	xx		xx	xx

004: Parameter value to be modified

5000: Parameter value in address

Response (VFD-> master station)

	PKW1		PKW2		PKW3		PKW4		CW		PZD2		PZD3		...	PZD12	
Response	00	01	00	10	00	00	50	00	xx	xx	xx	xx	xx	xx	...	xx	xx

0001: Response (parameter value updated)

PZD examples: The transmission of the PZD zone is implemented through VFD function code settings. For the function codes, see the related INVT VFD operation manual.

Example 1: Reading the process data of a VFD

In this example, PZD3 is set to "8: Rotating speed of the running" through the VFD parameter

P15.14. This operation sets the parameter forcibly. The setting remains until the parameter is set to another option.

Response (VFD -> master station)

	PKW1		PKW2		PKW3		PKW4		CW		PZD2		PZD3		...	PZD12	
Response	xx	xx	xx	xx	xx	xx	xx	xx	xx	xx	xx	xx	00	0A	...	xx	xx

Example 2: Writing process data to a VFD device

In this example, PZD3 is set to "2: PID reference" through the VFD parameter P15.03. The parameter specified in each request frame is updated with the information contained in PZD3 until another parameter is specified.

Request (master station -> VFD)

	PKW1		PKW2		PKW3		PKW4		CW		PZD2		PZD3		...	PZD12	
Response	xx	xx	xx	xx	xx	xx	xx	xx	xx	xx	xx	xx	00	00	...	xx	xx

Subsequently, the information contained in PZD3 is used as tractive force reference in each request frame until another parameter is specified.

## Chapter 3 CANopen communication card

### 3.1 Overview

1. Thanks for choosing INVT CANopen communication cards. This manual describes the function specifications, installation, basic operation and settings, and information about the network protocol. To ensure that you install and operate the product properly, read this manual and the communication protocol section in the VFD operation manual carefully before you use the product.
2. This manual only describes how to operate the CANopen communication card and the related commands but does not provide details about the CANopen protocol. For more information about the CANopen protocol, read the related specialized articles or books.
3. This communication card is defined as a CANopen slave station communication card and is used on a VFD that supports CANopen communication.
4. The CANopen communication of this communication card supports access to VFDs through process data objects (PDOs) and service data objects (SDOs). PDOs and SDOs are used to read the object dictionary defined by the manufacturer.

### 3.2 Features

1. Supported functions
  - Supports the CAN2.0A protocol.
  - Supports CANopen DS301.
2. Supported CANopen services
  - PDO: Supports four pairs of PDO services (PDO1 TX to PDO4 TX, and PDO1 RX to PDO4 RX), where the PDO1 pair is used to read and write parameters of a VFD, and the PDO2 to PDO4 pairs are used to control and obtain the actual parameter values of the VFD in real time.
  - SDO: SDO information adopts the "client/server" mode and is used to configure slave nodes and provide access to the object dictionary of each node.
  - Supports the emergency service.
  - Supports node protection (NMT Node Guarding).
  - Supports heartbeat packets (Heartbeat Producer).
  - Supports network management (NMT).
    - Supports NMT module control.
    - Supports NMT broadcast addresses.
    - Supports NMT error control.

- Supports boot-up.
  - Supports SYNC (1–240).
  - Supports asynchronous transmission of 254 and 255.
  - Supports disabled time.
  - Supports event timers.
  - Supports manufacturer-defined object dictionary. You can use SDOs to control and obtain the actual parameter values of a VFD in real time.
3. Non-supported CANopen services
    - Saves object dictionary parameters at power outage
    - Time stamp service
  4. Supported CANopen addresses and baud rates

Table 3-1 Supported addresses and baud rates

Item	Supported specification
Address	1–127 (decimal)
Baud rate	1000 kbps
	800 kbps
	500 kbps
	250 kbps
	125 kbps
	100 kbps
	50 kbps
	20 kbps

**Note:** To enable the CANopen functions (except the CANopen communication timeout fault time and baud rate), you need only to select the related PROFIBUS channels. If modification is made on the VFD operation manual, the operation is subject to the CANopen channel, without prior notice in this manual.

### 3.3 Electrical wiring

Use shielding wires in the bus cable, if possible. It is recommended that you connect the shielding wire to the CANG terminal of the VFD. When the communication card functions as the terminal slave, it is recommended that you switch on the terminal resistor. Figure 3-1 shows the electrical wiring.

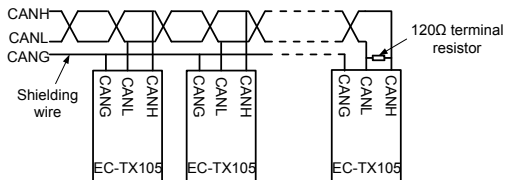

Figure 3-1 Electrical wiring diagram

## 3.4 Communication

### 3.4.1 Packet format

CAN2.0A packets are used to transmit data between the master station and bus nodes through data frames.

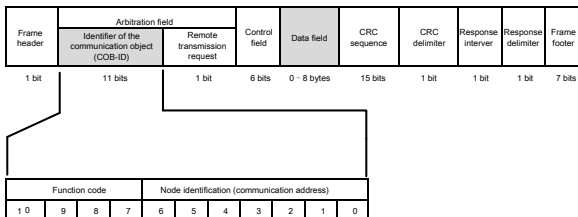

Figure 3-2 Packet structure

Communication object	Function code (binary)	COB-ID (hexadecimal)
NMT	0	0x00
SYNC	1	0x80
EMERGENCY	1	0x81–0xFF
PDO1 Tx	11	0x181–0x1FF
PDO1 Rx	100	0x201–0x27F
PDO2 Tx	101	0x281–0x2FF
PDO2 Rx	110	0x301–0x37F
PDO3 Tx	111	0x381–0x3FF
PDO3 Rx	1000	0x401–0x47F
PDO4 Tx	1001	0x481–0x4FF
PDO4 Rx	1010	0x501–0x57F
SDO Tx	1011	0x581–0x5FF
SDO Rx	1100	0x601–0x67F
Node protection	1110	0x701–0x77F



COB-IDs vary according to communication address, but for one command, the COB-IDs are within a certain range.

**Note:** The commands described in this manual are all data frames if it is not specified that they are remote frames.

### 3.4.2 CANopen state transition

The start sequence defined in the CANopen communication protocol is supported. Figure 3-3 shows the NMT state transition diagram.

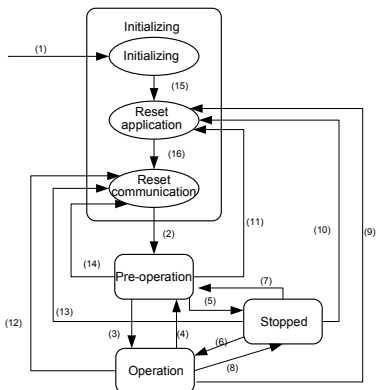

Figure 3-3 NMT state diagram

Table 3-2 NMT state transition

State transition	Required triggering event
(1)	Automatic initialization after power-on
(2)	Automatic change after initialization
(3), (6)	Command of the NMT master station for starting a remote node
(4), (7)	Command of the NMT master station for entering the pre-operation state
(5), (8)	Command of the NMT master station for entering the stopped state
(9), (10), (11)	Command of the NMT master station for resetting a remote node
(12), (13), (14)	Command of the NMT master station for resetting a remote node communication parameter

Different services are supported in different states, as described in Table 3-3.

Table 3-3 Services supported in various NMT states

Service	Pre-operation state	Operation state	Stopped state
PDOs	No	Yes	No
SDOs	Yes	Yes	No
SYNC packets	Yes	Yes	No
Emergency packets	Yes	Yes	No
Network management	Yes	Yes	No
Error control	Yes	Yes	Yes

### 3.4.3 Management service command (NMT)

This function is used by the master station to control the NMT states of slave station nodes.

- Command

Master station -> slave station

COB-ID	Byte0	Byte1
0x000	Command specifier (CS)	Node-ID (Node ID)

- Description

In this command, the COB-ID is 0x00. If Node-ID is set to 0, the command is broadcast to all CANopen slave stations, and each slave station must execute the NMT command. Table 3-4 describes the function of each CS.

Table 3-4 Function of each CS

NMT CS	NMT service (control action)
0x01	Starts a slave station device.
0x02	Stops a slave station device.
0x80	Enables a slave station to enter the pre-operation state.
0x81	Resets a slave station.
0x82	Resets communication of a node.

- Example

For example, the command to enable EC-TX105, whose node ID is 3, to enter the pre-operation state is described as follow.

COB-ID	Byte0	Byte1
0x000	0x80	0x03

For another example, the command to start all EC-TX105 nodes on the CANopen network is described as follows.

COB-ID	Byte0	Byte1
0x000	0x01	0x00

### 3.4.4 Node protection (NMT Node Guarding)

By using the node protection service, the NMT master node can detect the current state of each node.

#### ● Command

Request: Master station (remote frame) → slave station

COB-ID	No data
0x700 + Node-ID	

Response: Slave station → master station

COB-ID	Byte0 (state value)
0x700 + Node-ID	Bit 7: Triggering bit; Bits 0 to 6: State

#### ● Description

The most significant bit (MSB) bit 7 of Byte0 (state value) in the response command is the triggering bit, that is, the value of bit 7 is alternated between 0 and 1 each time when the slave station transmits a response frame to distinguish frames. Bits 0 to 6 indicate the state of the slave station. Table 3-5 describes the state values and their corresponding state.

Table 3-5 State values and their corresponding states

State value (Byte0: Bits 0–6)	State
0x00	Initializing
0x04	Stopped
0x05	Operation
0x7F	Pre-operational

#### ● Example

For example, the command for the master station to detect the state of slave station 3.

Master station (remote frame) → slave station

COB-ID	No data
0x703	/

After receiving the node protection command transmitted by the master station, the slave station transmits the following command response to the master station.

COB-ID	Byte0 (state value)
0x703	0x85

In the command, bit 7 of Byte0 is 1, and the state value is 0x05, indicating that slave station 3 is in the operation state. If receiving another node protection command, the slave station transmits a command frame in which the state value is 0x05 to the master station, and the

value of bit 7 is alternated to 0.

### 3.4.5 Heartbeat packet (Heartbeat Producer)

In some cases, the master station requires that a slave station automatically transmits a frame of heartbeat packets at an interval, so that it can learn the state of the slave station in real time. The interval parameter (data length: 16 bits; unit: ms) is defined in the object dictionary 0x1017. If the interval is set to 0, the slave station does not transmit heartbeat packets. For this CANopen communication card, the interval is set to 0 by default.

- Command

Slave station -> master station

COB-ID	Byte0
0x700 + Node-ID	State value

- Description

The heartbeat packets are in the same format with the node protection response frames. The difference between them is that no triggering bit alternation is performed for heartbeat packets (the triggering bit is always 0). Table 3-5 describes the state values.

- Example

For example, if slave station 3 is in the operation state and the interval parameter in 0x1017 is set to 100, slave station 3 transmits a frame of heartbeat packets every 100 ms.

COB-ID	Byte0
0x703	0x05

SDOs can be used to disable heartbeat packets, transmitting 2B 17 10 00 00 00 00 00 (setting the interval to 0).

**Note:** On the communication card, node protection and heartbeat packets cannot be used simultaneously.

### 3.4.6 Start packet (NMT Boot-up)

After being initialized (booted up), the communication card transmits a start packet.

- Command

Slave station -> master station

COB-ID	Byte0
0x700 +Node-ID	0x00

- Example

For example, after being initialized, the communication card whose node ID is 3 transmits the following start packet.

COB-ID	Byte0
0x703	0x00

### 3.4.7 Synchronous packet object (SYNC)

Generally, SYNC signals are transmitted by the CANopen master station cyclically. A SYNC signal does not contain any data and is used mainly to request PDO Tx of a slave station node of the synchronous transmission type. 0x1005 in the object dictionary defines COB-IDs of the objects that receive synchronous packets, and they are set to 0x80 in the CANopen pre-defined connection set. For PDO Tx, the transmission types of 1 to 240 indicate synchronous transmission.

- Command

Master station -> slave station

COB-ID	No data
0x80	/

### 3.4.8 Emergency packet object (EMCY)

This packet is transmitted when an internal error occurs on the communication card or VFD, or an error is deleted.

- Command

Slave station -> master station

COB-ID	Byte0	Byte1	Byte2	Byte3	Byte4	Byte5	Byte6	Byte7
0x80 + Node-ID	Emergency error code		Error register	VFD error code				
	LSB	MSB		bit7-0	bit15-8	bit23-16	bit31-24	bit39-32

- Description

An emergency error code is two bytes. Byte0 is the least significant byte (LSB), and Byte1 is the most significant byte (MSB). A VFD error code is five bytes. Byte3 is the LSB, and Byte7 is the MSB.

An emergency error code indicates the type of the current error, as described in Table 3-6. The error register stores the type of the current error. You can determine the error type indicated by the current emergency packet according to the value stored in the register. Table 3-7 describes the indication of the bits of the error register. For information about the VFD error codes, see the VFD operation manual. The function code P07.27 in Appendix B describes the error codes of Goodrive350 VFD.

Table 3-6 Emergency error codes

Emergency error code (hex)	Code function description
00xx	Error reset or no error
10xx	Generic error
20xx	Current
21xx	Current error on the, device input side

Emergency error code (hex)	Code function description
22xx	Current error inside the device
23xx	Current error on the device output side
30xx	Voltage error
31xx	Mains voltage
32xx	Voltage inside the device
33xx	Output voltage
40xx	Temperature
41xx	Ambient temperature
42xx	Device temperature
50xx	Device hardware
60xx	Device software
61xx	Internal software
62xx	User software
63xx	Data set
70xx	Additional modules
80xx	Monitoring
81xx	Communication error
8110	CAN overrun
8120	Error passive
8130	Life guard Error or heartbeat error
8140	Recovered from Bus-Off
82xx	Protocol error
8210	PDO not processed due to length error
8220	Length exceeded
90xx	External error
F0xx	Additional functions
FFxx	Device specific

Table 3-7 Error register bits

Error register bit	Error type
0	Generic error or no error
1	Current error
2	Voltage error
3	Temperature error
4	Communication error
5	Device description error
6	Reserved (=0)
7	Manufacturer-defined error

- Example

For example, if the "inverter unit phase U protection (OUT1)" fault occurs on the Goodrive350 VFD whose node ID is 3, and the fault type is 1 (that is, the VFD error code is 1), the communication card transmits the following emergency packet.

COB-ID	Emergency error code		Error register	VFD error code				
	Byte0	Byte1	Byte2	Byte3	Byte4	Byte5	Byte6	Byte7
0x83	0x00	0x30	0x04	0x01	0x00	0x00	0x00	0x00

As you can see in the command, the emergency error code is 0x3000, indicating a voltage error. The error register is 0x04, that is, the second bit is "1", indicating a voltage error. The device error code is 0x0000000001. See the Goodrive350 VFD operation manual, and you can find that the error code 1 indicates the "inverter unit phase U protection (OUT1)" fault.

After the fault is reset, the communication card transmits the following emergency packet to notify the master station that the slave station is no longer faulty.

COB-ID	Emergency error code		Error register	VFD error code				
	Byte0	Byte1	Byte2	Byte3	Byte4	Byte5	Byte6	Byte7
0x83	0x00	0x00	0x00	0x00	0x00	0x00	0x00	0x00

### 3.4.9 Service data object (SDO)

SDOs are mainly used to transmit non-time key data. By using SDOs, the master station can read data from and write data to the object dictionary of a device.

#### ● Command

Request: master station -> slave station

COB-ID	Byte0	Byte1	Byte2	Byte3	Byte4	Byte5	Byte6	Byte7
0x600+NodeID	Request code	Object index		Subindex	Response data			
		LSB	MSB		bit7-0	bit15-8	bit23-16	bit31-24

Response: Slave station -> master station

COB-ID	Byte0	Byte1	Byte2	Byte3	Byte4	Byte5	Byte6	Byte7
0x580+NodeID	Response code	Object index		Subindex	Response data			
		LSB	MSB		bit7-0	bit15-8	bit23-16	bit31-24

#### ● Description

An object index is two bytes. Byte1 is the LSB, and Byte2 is the MSB. For information about the indexes and subindexes, see the object dictionary in the appendix. Request codes include request codes for reading and those for writing.

Request codes for writing vary according to the character length of items in the object dictionary, and the request code for reading are 0x40. See Table 3-8.

Response codes indicating successful reading vary according to the character length of items in the object dictionary, and the response code indicating successful writing are 0x60. The response codes indicating reading failure and writing failure are both 0x80. See Table 3-9.

Table 3-8 SDO request codes and requested data

Request code type	Request code	Command description	Requested data			
			Byte4	Byte5	Byte6	Byte7
Write	0x23	Writes 4-byte data	bit7-0	bit15-8	bit23-16	bit31-24
	0x2B	Writes 2-byte data	bit7-0	bit15-8	-	-
	0x2F	Writes 1-byte data	bit7-0	-	-	-
Read	0x40	Reads data	-	-	-	-

Table 3-9 SDO response codes and response data

Response code type	Response code	Command description	Response data			
			Byte4	Byte5	Byte6	Byte7
Read	0x43	Reads 4-byte data	bit7-0	bit15-8	bit23-16	bit31-24
	0x4B	Reads 2-byte data	bit7-0	bit15-8	-	-
	0x4F	Reads 1-byte data	bit7-0	-	-	-
Write	0x60	Writing succeeds	-	-	-	-
Read/write	0x80	Reading/writing fails	Interruption error code			
			bit7-0	bit15-8	bit23-16	bit31-24

**Note:** The symbol "-" in Table 3-8 and Table 3-9 indicates that the byte is reserved and provides no function.

Table 3-10 describes the interruption error codes.

Table 3-10 Interruption error codes

Interruption code	Code function description
0503 0000	Triggering bit not alternated
0504 0000	SDO protocol times out
0504 0001	Invalid or unknown client/server
0504 0002	Invalid block size
0504 0003	Invalid sequence number
0504 0004	CRC error
0504 0005	Memory overflow
0601 0000	No access to the object
0601 0001	Attempts to read a write-only object
0601 0002	Attempts to write information to a read-only object
0602 0000	Object cannot be found in the object dictionary
0604 0041	Object cannot be mapped to PDO
0604 0042	Number and length of the object to be mapped exceeds the PDO



Interruption code	Code function description
	length
0604 0043	Common parameter incompatibility
0604 0047	Common internal incompatibility of the device
0606 0000	Object access failure caused by hardware error
0607 0010	Data type not matched; service parameter length not matched
0609 0011	Subindex cannot be found in the object dictionary
0609 0030	Parameter value range exceeded
0609 0031	Written parameter value too large
0609 0032	Written parameter value too small
0609 0036	Max. value less than Min. value
0800 0000	Common error
0800 0020	Data failed to be transmitted or stored in the application
0800 0021	Data failed to be transmitted or stored in the application due to device control
0800 0022	Data failed to be transmitted or stored in the application due to the current state of the device
0800 0023	Error occurs dynamically on the object dictionary or object dictionary cannot be found

● Example

For example, slave station 3 reads data from and writes data to the object whose index is 0x1801 and subindex is 03. (The object whose index is 0x1801 and subindex is 03 indicates the disabled time of PDO2 Tx. For more information, see Appendix A.)

Write operation example: To modify the disabled time of PDO2 Tx to 1000 ms, the master station transmits the following write operation command.

COB-ID	Request code	Object index		Subindex	Requested data			
	Byte0	Byte1	Byte2	Byte3	Byte4	Byte5	Byte6	Byte7
0x603	0x2B	0x01	0x18	0x03	0xe8	0x03	0x00	0x00

After receiving the command transmitted by the master station, the slave station transmits the following command response if the modification is successful.

COB-ID	Response code	Object index		Subindex	Response data			
	Byte0	Byte1	Byte2	Byte3	Byte4	Byte5	Byte6	Byte7
0x583	0x60	0x01	0x18	0x03	0x00	0x00	0x00	0x00

Read operation example: To read the disabled time of PDO2 Tx, the master station transmits

the following read operation command.

COB-ID	Request code	Object index		Subindex	Requested data			
	Byte0	Byte1	Byte2	Byte3	Byte4	Byte5	Byte6	Byte7
0x603	0x40	0x01	0x18	0x03	0x00	0x00	0x00	0x00

After receiving the command transmitted by the master station, the slave station transmits the following command response if the current disabled time of PDO2 Tx is 1000 ms.

COB-ID	Response code	Object index		Subindex	Response data			
	Byte0	Byte1	Byte2	Byte3	Byte4	Byte5	Byte6	Byte7
0x583	0x43	0x01	0x18	0x03	0xe8	0x03	0x00	0x00

Read/write error example: The master station transmits the following read operation command to read an object (whose index is 0x6000 and subindex is 0x00) that cannot be found.

COB-ID	Request code	Object index		Subindex	Requested data			
	Byte0	Byte1	Byte2	Byte3	Byte4	Byte5	Byte6	Byte7
0x603	0x40	0x00	0x60	0x00	0x00	0x00	0x00	0x00

The object cannot be found, and therefore the slave station transmits the following read/write error command response.

COB-ID	Response code	Object index		Subindex	Response data			
	Byte0	Byte1	Byte2	Byte3	Byte4	Byte5	Byte6	Byte7
0x583	0x80	0x00	0x60	0x00	0x00	0x00	0x02	0x06

The error code in the response is 0x06020000, indicating that "Object cannot be found in the object dictionary".

### 3.5 Process data object (PDO)

The communication card provides four PDO Tx commands (whose indexes are 0x1800 to 0x1803) and four PDO Rx commands (whose indexes are 0x1400 to 0x1403). PDO Rx is a PDO command transmitted by the master station to a slave station, that is, it is a master station command. PDO Tx is a PDO command transmitted by a slave station to the master station.

The CW, SW, setting, and return value of each PDO of the communication card are all defined with a "manufacturer-defined object dictionary". In this way, the process data of a VFD can be monitored not only through PDOs but also through SDOs. For more information, see the next chapter. Each PDO command is labeled with "manufacturer-defined object dictionary" in the format of 0xXXXX.HH, where XXXX indicates an index, HH indicates a subindex, and both of them are hexadecimal.

### 3.5.1 Triggering mode of PDO Tx

Each PDO Tx is defined with a transmission type, disabled time, and event timer. The corresponding subindex of the transmission type is 0x02, that of the disabled time is 0x03, and that of the event timer is 0x05. Therefore, the object dictionary index corresponding to PDO2 Tx is 0x1801, and the subindex is 0x02. The same principle applies to other PDO Tx commands. For more information, see Appendix A.

**Synchronous triggering:** When the transmission type is set to 1 to 240, PDO Tx is synchronous transmission. For example, if you set the transmission type of PDO2 Tx to  $n$  ( $1 \leq n \leq 240$ ), a slave station transmits one PDO2 Tx command every time after it receives  $n$  synchronous packet objects. The same principle applies to other PDO Tx commands.

**Asynchronous triggering (254):** When the value of the event timer is not zero, a slave station transmits PDO Tx commands periodically. For example, if the event timer of PDO2 Tx is set to 200, the slave station transmits a PDO2 Tx command at the interval of 200 ms. When the value of the event timer is zero, the slave station transmits a PDO Tx command once the corresponding PDO Tx data changes, and the transmission interval is subject to the disabled time. A PDO Tx packet can be transmitted only once in the disabled time, which effectively reduces the load of the bus. When the disabled time is set to a period shorter than 50 ms, 50 ms is used as the disabled time.

**Asynchronous triggering (255):** When the value of the event timer is not zero, a slave station transmits PDO Tx commands periodically. For example, if the event timer of PDO2 Tx is set to 200, the slave station transmits a PDO2 Tx command at the interval of 200 ms. When the value of the event timer is zero, the slave station transmits a PDO Tx command once a corresponding PDO Rx command is received. For example, after receiving a PDO2 Rx command, the slave station transmits a PDO2 Tx command.

Table 3-11 Triggering modes supported by the communication card

Triggering mode	Transmission type (decimal)	Event triggering	PDO1 TX	PDO2 TX	PDO3 TX	PDO4 TX
Synchronous	1–240	/	Non-supported	Supported	Supported	Supported
Asynchronous	254	Event timer	Non-supported	Supported	Supported	Supported
		Disabled time	Non-supported	Supported	Supported	Supported
	255	Event timer=0	Supported	Supported	Supported	Supported
		Event timer=0	Non-supported	Supported	Supported	Supported

Table 3-12 Default PDO Tx settings of the communication card

	PDO1 TX	PDO2 TX	PDO3 TX	PDO4 TX
Transmission type	255	254	254	254

	PDO1 TX	PDO2 TX	PDO3 TX	PDO4 TX
Event timer (ms)	0	0	0	0
Disabled time (ms)	500	500	500	500

For how to set the triggering type of PDO Tx, see the description of SDO commands.

### 3.5.2 PDO1

PDO1 is used to read and write parameters of the VFD. The function of PDO1 is similar to that of an SDO. SDOs are used to read and write objects of an object dictionary, and PDO1 is used to read and write parameters of the VFD.

**Note:** PDO1 Tx support only the transmission type of asynchronous transmission 255. Do not set it to other transmission types, and do not try to set the event timer to periodically transmits PDO1 Tx to the master station.

#### 3.5.2.1 PDO1 Rx

- Command

Request: Master station → slave station

COB-ID	Byte0	Byte1	Byte2	Byte3	Byte4	Byte5
0x200+NODE-ID	Request code		Parameter address		Requested data	
	0x2100.00		0x2100.01		0x2100.02	

- Description

A request code is two bytes. Byte0 is the LSB, and Byte1 is the MSB. The manufacturer defines the index 0x2100 and subindex 0x00 for the request codes. Table 3-13 describes the functions of the request codes.

Table 3-13 Request codes

Request code	Function
0	No task
1	Reading the value of a parameter
2	Modifying a parameter value [modifying the value only on RAM]
4	Modifying a parameter value [modifying the value only on both RAM and EEPROM] (reserved)

A parameter address is two bytes. Byte2 is the LSB, and Byte3 is the MSB. It indicates the address of the parameter to be read or modified.

Goodrive350 series VFD function code address representation rules: The MSB is the hexadecimal form of the number before the dot mark, and LSB is that of the number behind the dot mark. Take P10.01 as an example, the number before the dot mark is 10, that is, the MSB of the parameter address is 0×0A; and the number behind the dot mark is 01, that is, the LSB is 0×01. Therefore, the function code address is 0×0A01.

Table 3-14 Goodrive350 series VFD parameter addresses

Function code	Name	Detailed parameter description	Default value	Modify
P10.00	Simple PLC mode	0: Stops after running once 1: Keeps running in the final value after running once 2: Cyclic running	0	<input type="radio"/>
P10.01	Simple PLC memory selection	0: Not saving data at power outage 1: Saving data at power outage	0	<input type="radio"/>

VFD parameter address representation rules: You can see the function code in the function parameter list in the VFD operation manual. The hexadecimal form of the value corresponding to the function code is the parameter address. For example, the value corresponding to the function code P13.14 is 1314, and therefore the parameter address of the function code is 0x522 (that is, 1314 in the decimal form).

A piece of requested data is two bytes. Byte4 is the LSB, and Byte5 is the MSB. It indicates the data to be modified. When the command is transmitted for reading data, the requested data is not used.

**Note:** The data domain of PDO1 Rx must be six bytes. Otherwise, the communication card reports an emergency packet.

### 3.5.2.2 PDO1 Tx

- Command

Response: Slave station -> master station

COB-ID	Byte0	Byte1	Byte2	Byte3	Byte4	Byte5	Byte6	Byte7
0x180+NODEID	Response code		Error code		Response data		0x00	0x00
	0x2000.00		0x2000.01		0x2000.02		-	-

- Description

Byte6 and Byte7 are reserved and both are 0x00.

A response code is two bytes. Byte0 is the LSB, and Byte1 is the MSB. Table 3-15 describes the functions of the response codes.

Table 3-15 Response codes

Response code	Function
0	No response
1	Reading or writing succeeds
3	A reading or writing error occurs. Table 3-16 describes the error codes.

A piece of response data is four bytes. Byte4 is the LSB, and Byte7 is the MSB. When a write command is responded, the response data is the data to be modified; and when a read

command is responded, the response data is the data to be read.

An error code is two bytes. Byte2 is the LSB, and Byte3 is the MSB. Error codes are valid only when the response code is 3. An error code indicates the reason why it fails to respond to PDO1 Rx. Table 3-16 describes the definitions of the error codes.

Table 3-16 Error codes

Code	Name	Definition
00H	No error	/
01H	Invalid command	The operation corresponding to the request code is not allowed to be executed. The possible causes are as follows: <ul style="list-style-type: none"> <li>• The function code is applicable only on new devices and is not implemented on this device.</li> <li>• The slave station is in the faulty state when processing this request.</li> </ul>
02H	Invalid data address	For a slave device, the data address in the request of the master station is not allowed. In particular, the combination of the register address and the number of the to-be-transmitted bytes is invalid.
03H	Invalid data value	The received data domain contains a value that is not allowed. The value indicates the error of the remaining structure in the combined request. <b>Note:</b> It does not mean that the data item submitted for storage in the register includes a value unexpected by the program.
04H	Operation failure	The parameter is set to an invalid value in the write operation. For example, a function input terminal cannot be set repeatedly.
05H	Password error	The password entered in the password verification address is different from that set by the user.
06H	Data frame error	The length of the data frame transmitted by the upper computer is incorrect, or in the RTU format, the value of the CRC check bit is inconsistent with the CRC value calculated by the lower computer.
07H	Parameter read-only	The parameter to be modified in the write operation of the master station is a read-only parameter.
08H	Parameter cannot be modified in running	The parameter to be modified in the write operation of the master station cannot be modified during the running of the VFD.

Code	Name	Definition
09H	Password protection	A user password is set, and the master station does not provide the password to unlock the system when performing a read or write operation. The error of system locked is reported.

- Example of PDO1

The VFD is a Goodrive350 series VFD, and the slave station address is 3. Assume that you want to set the function code P15.13 of the VFD to 1.

Command analysis: The parameter address of P15.13 is 0×0F0D. According to the protocol, the request code of PDO1 Rx is 0×02, the parameter address is 0x0F0D, and the requested data is 0x01, and therefore PDO1 Rx transmitted by the master station is as follows.

COB-ID	Request code		Parameter address		Requested data	
	Byte0	Byte1	Byte2	Byte3	Byte4	Byte5
0x203	0x02	0x00	0x0D	0x0F	0x01	0x00

If the VFD parameter is successfully modified, the following PDO1 Tx command is returned.

COB-ID	Response code		Error code		Response data		-	
	Byte0	Byte1	Byte2	Byte3	Byte4	Byte5	Byte6	Byte7
0x183	0x01	0x00	0x00	0x00	0x01	0x00	0x00	0x00

### 3.5.3 PDO2 Rx

PDO2 Rx is used to modify CWs and real-time process data (setting 1, setting 2, and setting 3) of a VFD. A CW is used to control the start and stop of a VFD, and settings are used to control the real-time running values of the VFD, such as set frequency.

- Command

Master station -> slave station

COB-ID	Byte0	Byte1	Byte2	Byte3	Byte4	Byte5	Byte6	Byte7
0x300+NODEID	CW		Setting 1		Setting 2		Setting 3	
	0x2101.00		0x2100.03		0x2100.04		0x2100.05	

- Description

A CW is two bytes. Byte0 is the LSB, and Byte1 is the MSB. Table 3-17 describes Goodrive350 series VFD CWs.

Table 3-17 Goodrive350 series VFD CWs

Bit	Name	Value	Description
0-7	Communication-based control command	1	Forward running
		2	Reverse running

Bit	Name	Value	Description
		3	Forward jogging
		4	Reverse jogging
		5	Stop
		6	Coast to stop (emergency stop)
		7	Fault reset
		8	Stop jogging
8	Enable write	1	Enable writing (mainly through PKW1 to PKW4)
9–10	Motor group setting	00	Motor 1
		01	Motor 2
11	Control mode switching	1	Enable torque/speed control switching
		0	Disable switching
12	Reset power consumption to zero	1	Enable
		0	Disable
13	Pre-excitation	1	Enable
		0	Disable
14	DC braking	1	Enable
		0	Disable
15	Heartbeat reference	1	Enable
		0	Disable

The function of each setting can be set through the corresponding function code of the VFD. The setting method is the same as that for "received PZD" in PROFIBUS communication. For details, see the VFD operation manual. Setting 1, setting 2, and setting 3 correspond to received PZD2, received PZD3, and received PZD4, respectively. To set the function of setting 1 to "Set frequency", you need only to set "Received PZD2" to "1: Set frequency". The same principle applies to other settings. When multiple settings are enabled, the failure to set one setting (for example, the set value exceeds the setting range) does not affect the setting of other settings.

#### ● Example

Assume that the VFD is a Goodrive350 series VFD, the slave station address is 3, you control the running of the VFD through CANopen communication, and you want to set the running frequency to 50 Hz through CANopen communication.

Command analysis: You need to set the VFD start mode and frequency reference mode to CANopen communication (P00.01=2, P00.02=1, P00.06=9) first. In this example, use Setting 2 to set the running frequency (P15.03=1, that is, set Received PZD3 to "1: Set frequency").

When a CW is 0x01, it indicates that the VFD is to be run. To set the frequency to 50 Hz, you



need to set Setting 2 to 5000, that is, 0x1388.

The PDO2 Rx command transmitted by the master station is as follows.

COB-ID	CW		Setting 1		Setting 2		Setting 3	
	Byte0	Byte1	Byte2	Byte3	Byte4	Byte5	Byte6	Byte7
0x303	0x01	0x00	0x00	0x00	0x88	0x13	0x00	0x00

### 3.5.4 PDO2 Tx

PDO2 Tx is a command transmitted by a VFD to the master station. It contains a SW and real-time process data (Returned value 1, returned value 2, and returned value 3). A SW is used to notify of the state of the VFD, and returned values are used to transmit the real-time running values of VFD, such as running frequency.

The default transmission type of PDO2 Tx is 254, and therefore PDO2 Tx is transmitted once data corresponding to a SW or returned value changes.

- Command

Slave station -> master station

COB-ID	Byte0	Byte1	Byte2	Byte3	Byte4	Byte5	Byte6	Byte7
0x280+NODEID	SW		Returned value 1		Returned value 2		Returned value 3	
	0x2001.00		0x2000.03		0x2000.04		0x2000.05	

- Description

A SW is two bytes. Byte0 is the LSB, and Byte1 is the MSB. Table 3-18 describes the definitions of the Goodrive350 series VFD SWs. For VFD of other series, see the corresponding VFD operation manual.

Table 3-18 Goodrive350 series VFD SWs

Bit	Name	Value	Description
0-7	Running state	1	In forward running
		2	In reverse running
		3	Stopped
		4	Faulty
		5	POFF
8	Bus voltage established	1	Ready to run
		0	Not ready to run
9-10	Motor group feedback	0	Motor 1
		1	Motor 2
11	Motor type feedback	1	Synchronous motor
		0	Asynchronous motor
12	Overload pre-alarm feedback	1	Overload pre-alarm generated
		0	No overload pre-alarm generated

Bit	Name	Value	Description
13–14	Run/stop mode	0	Keypad-based control
		1	Terminal-based control
		2	Communication-based control
		3	Reserved
15	Heartbeat feedback	1	Heartbeat feedback
		0	No heartbeat feedback

The function of each returned value can be set through the corresponding function code of the VFD. The setting method is the same as that for "transmitted PZD" in PROFIBUS communication. For details, see the VFD operation manual. Returned value 1, returned value 2, and returned value 3 correspond to transmitted PZD2, transmitted PZD3, and transmitted PZD4, respectively. To set the function of returned value 1 to "Running frequency", you need only to set "Transmitted PZD2" to "1: Running frequency". The same principle applies to other returned values. Multiple returned values can be enabled simultaneously.

- Example

Assume that the VFD is a Goodrive350 series VFD, the slave station address is 3, the VFD is running, and the running frequency is 50.00 Hz. Returned value 1 is set to "Running frequency", returned value 2 is set to "Output voltage", and returned value 3 is set to no function.

Command analysis: You need to set returned value 1 to the running frequency of the VFD (P15.13=1), returned value 2 to the output voltage of the VFD (P15.14=4), and returned value 3 to invalid (P15.15=0) first.

The VFD is running and the bus voltage has been established, and therefore the SW is 0x0101. The running frequency is 50.00 Hz, and therefore returned value 1 is 5000, that is, 0x1388. If the output voltage is 380 V, returned value 2 is 0x017C.

The PDO2 Tx command transmitted by the VFD is as follows.

COB-ID	SW		Returned value 1		Returned value 2		Returned value 3	
	Byte0	Byte1	Byte2	Byte3	Byte4	Byte5	Byte6	Byte7
0x283	0x01	0x01	0x88	0x13	0x7C	0x01	0x00	0x00

### 3.5.5 PDO3 Rx and PDO4 Rx

PDO3 Rx and PDO4 Rx are used to modify the real-time process data of a VFD, such as set frequency.

- PDO3 Rx command

Master station -> slave station

COB-ID	Byte0	Byte1	Byte2	Byte3	Byte4	Byte5	Byte6	Byte7
0x400+NODEID	Setting 4		Setting 5		Setting 6		Setting 7	
	0x2100.06		0x2100.07		0x2100.08		0x2100.09	

- PDO4 Rx command

Master station -> slave station

COB-ID	Byte0	Byte1	Byte2	Byte3	Byte4	Byte5	Byte6	Byte7
0x500+NODEID	Setting 8		Setting 9		Setting 10		Setting 11	
	0x2100.0a		0x2100.0b		0x2100.0c		0x2100.0d	

- Description

The application methods for PDO3 Rx and PDO4 Rx are the same as that for PDO2 Rx. For the relationship between the settings and PZD in PROFIBUS communication, see Table 3-19.

### 3.5.6 PDO3 Tx and PDO4 Tx

PDO3 Tx and PDO4 Tx are used by the VFD to transmit real-time process data to the master station, such as running frequency.

The default transmission type of PDO3 Tx and PDO4 Tx is 254, and therefore PDO3 Tx or PDO4 Tx is transmitted once data corresponding to a returned value in the same command changes.

- PDO3 Tx command

Slave station -> master station

COB-ID	Byte0	Byte1	Byte2	Byte3	Byte4	Byte5	Byte6	Byte7
0x380+NODEID	Returned value 4		Returned value 5		Returned value 6		Returned value 7	
	0x2000.06		0x2000.07		0x2000.08		0x2000.09	

- PDO4 Tx command

Slave station -> master station

COB-ID	Byte0	Byte1	Byte2	Byte3	Byte4	Byte5	Byte6	Byte7
0x480+NODEID	Returned value 8		Returned value 9		Returned value 10		Returned value 11	
	0x2000.0a		0x2000.0b		0x2000.0c		0x2000.0d	

- Description

The application methods for PDO3 Tx and PDO4 Tx are the same as that for PDO2 Tx. For the relationship between the returned values and PZD in PROFIBUS communication, see Table 3-20.

## 3.6 Monitoring process data through SDO commands

The communication can use SDOs as well as PDOs to monitor the process data of a VFD. You can select a monitoring mode as required. You can monitor the VFD by using SDOs to

read the manufacturer-defined object dictionary.

For the definition and application of the CWs, SWs, settings, and returned values in the manufacturer-defined object dictionary, see the PDO description section. For application of SDOs, see the SDO description section. Do not try to use SDOs to read and write VFD parameters.

Table 3-19 and Table 3-20 describe the manufacturer-defined object dictionary.

Table 3-19 Objects with the control function in the manufacturer-defined object dictionary

Index (hexadecimal)	Subindex (hexadecimal)	Function	Access permission	Data length	Corresponding to
2100	0	Request code (do not use it)	RW	2 bytes	/
	1	Parameter address (do not use it)	RW	2 bytes	/
	2	Requested data (do not use it)	RW	2 bytes	/
	3	Setting 1	RW	2 bytes	Received PZD2
	4	Setting 2	RW	2 bytes	Received PZD3
	5	Setting 3	RW	2 bytes	Received PZD4
	6	Setting 4	RW	2 bytes	Received PZD5
	7	Setting 5	RW	2 bytes	Received PZD6
	8	Setting 6	RW	2 bytes	Received PZD7
	9	Setting 7	RW	2 bytes	Received PZD8
	A	Setting 8	RW	2 bytes	Received PZD9
	B	Setting 9	RW	2 bytes	Received PZD10
	C	Setting 10	RW	2 bytes	Received PZD11
	D	Setting 11	RW	2 bytes	Received PZD12
	E	Reserved	RW	2 bytes	/
	F	Reserved	RW	2 bytes	/
2101	0	CW	RW	2 bytes	/

Table 3-20 Objects with the monitoring function in the manufacturer-defined object dictionary

Index (hexadecimal)	Subindex (hexadecimal)	Function	Access permission	Data length	Corresponding to
2000	0	Response code (do not use it)	RO	2 bytes	/
	1	Error code (do not use it)	RO	2 bytes	/

Index (hexadecimal)	Subindex (hexadecimal)	Function	Access permission	Data length	Corresponding to
	2	Response data (do not use it)	RO	2 bytes	/
	3	Returned value 1	RO	2 bytes	Transmitted PZD2
	4	Returned value 2	RO	2 bytes	Transmitted PZD3
	5	Returned value 3	RO	2 bytes	Transmitted PZD4
	6	Returned value 4	RO	2 bytes	Transmitted PZD5
	7	Returned value 5	RO	2 bytes	Transmitted PZD6
	8	Returned value 6	RO	2 bytes	Transmitted PZD7
	9	Returned value 7	RO	2 bytes	Transmitted PZD8
	A	Returned value 8	RO	2 bytes	Transmitted PZD9
	B	Returned value 9	RO	2 bytes	Transmitted PZD10
	C	Returned value 10	RO	2 bytes	Transmitted PZD11
	D	Returned value 11	RO	2 bytes	Transmitted PZD12
	E	Reserved	RO	2 bytes	/
	F	Reserved	RO	2 bytes	/
2001	0	SW	RO	2 bytes	/

● Examples

Example 1: To instruct the VFD whose address is 3 to run forwardly, the master station transmits the following SDO command.

COB-ID	Request code	Object index		Subindex	Requested data			
	Byte0	Byte1	Byte2	Byte3	Byte4	Byte5	Byte6	Byte7
0x603	0x2B	0x01	0x21	0x00	0x01	0x00	0x00	0x00

Example 2: Assume that the address of the VFD slave station is 3, and the function of setting 1

is defined as "Set frequency". To set the frequency to 50.00 Hz (that is, setting 1=0x1388), the master station transmits the following SDO command.

COB-ID	Request code	Object index		Subindex	Requested data			
	Byte0	Byte1	Byte2	Byte3	Byte4	Byte5	Byte6	Byte7
0x603	0x2B	0x00	0x21	0x03	0x88	0x13	0x00	0x00

Example 3: To read the running state of the VFD whose address is 3, the master station transmits the following SDO command.

COB-ID	Request code	Object index		Subindex	Requested data			
	Byte0	Byte1	Byte2	Byte3	Byte4	Byte5	Byte6	Byte7
0x603	0x40	0x01	0x20	0x00	0x00	0x00	0x00	0x00

If the VFD is running forward, the following SDO command is returned to the master station.

COB-ID	Request code	Object index		Subindex	Requested data			
	Byte0	Byte1	Byte2	Byte3	Byte4	Byte5	Byte6	Byte7
0x583	0x4B	0x01	0x20	0x00	0x01	0x01	0x00	0x00

Example 4: Assume that the address of the VFD slave station is 3, and the function of setting 1 is defined as "Set frequency". To set the frequency to 50.00 Hz (that is, setting 1=0x1388), the master station transmits the following SDO command.

COB-ID	Request code	Object index		Subindex	Requested data			
	Byte0	Byte1	Byte2	Byte3	Byte4	Byte5	Byte6	Byte7
0x603	0x40	0x00	0x20	0x03	0x00	0x00	0x00	0x00

If the running frequency of the VFD is 50.00 Hz, the following SDO command is returned to the master station.

COB-ID	Request code	Object index		Subindex	Requested data			
	Byte0	Byte1	Byte2	Byte3	Byte4	Byte5	Byte6	Byte7
0x583	0x4B	0x00	0x20	0x03	0x88	0x13	0x00	0x00

## 3.7 Baud rate and communication address setting

### 3.7.1 Baud rate setting

After setting the CANopen baud rate and communication address, you need to restart the VFD to enable the settings to take effect.

The CANopen baud rate is set through the corresponding VFD function parameter. For

description of function code addresses, see the VFD operation manual. Table 3-21 describes the values of the function parameter and their corresponding baud rates.

Table 3-21 Baud rate setting

Function parameter value	Baud rate (bit/s)
0	1000 k
1	800 k
2	500 k
3	250 k
4	125 k
5	100 k
6	50 k
7	20 k

### 3.7.2 Communication address setting

The CANopen communication address is set through the function parameter P15.01.

### 3.7.3 Function codes related to transmitted and received PZD

Table 3-22 Received PZD

Function code	Word	Value range	Default value
P15.02	Received PZD2	0: Invalid	0
P15.03	Received PZD3	1: Set frequency (0–Fmax, unit: 0.01 Hz)	0
P15.04	Received PZD4	2: PID reference (0–1000, in which 1000 corresponds to 100.0%)	0
P15.05	Received PZD5	3: PID feedback (0–1000, in which 1000 corresponds to 100.0%)	0
P15.06	Received PZD6	4: Torque setting (-3000–+3000, in which 1000 corresponds to 100.0% of the rated current of the motor)	0
P15.07	Received PZD7	5: Setting of the upper limit of forward running frequency (0–Fmax, unit: 0.01 Hz)	0
P15.08	Received PZD8	6: Setting of the upper limit of reverse running frequency (0–Fmax, unit: 0.01 Hz)	0
P15.09	Received PZD9	7: Upper limit of the electromotive torque (0–3000, in which 1000 corresponds to 100.0% of the rated current of the motor)	0
P15.10	Received PZD10	8: Upper limit of the brake torque (0–2000, in which 1000 corresponds to 100.0% of the rated current of the motor)	0
P15.11	Received	9: Virtual input terminal command, 0x000–0x3FF (corresponding to S8, S7, S6, S5, HDIB, HDIA, S4, S3,	0

Function code	Word	Value range	Default value
	PZD11	S2, and S1 in sequence)	
P15.12	Received PZD12	10: Virtual output terminal command, 0x00–0x0F (corresponding to RO2, RO1, HDO, and Y1 in sequence) 11: Voltage setting (for V/F separation) (0–1000, in which 1000 corresponds to 100.0% of the rated voltage of the motor) 12: AO output setting 1 (-1000–+1000, in which 1000 corresponds to 100.0%) 13: AO output setting 2 (-1000–+1000, in which 1000 corresponds to 100.0%) 14: MSB of position reference (signed number) 15: LSB of position reference (unsigned number) 16: MSB of position feedback (signed number) 17: LSB of position feedback (unsigned number) 18: Position feedback setting flag (position feedback can be set only after this flag is set to 1 and then to 0)	0

Table 3-23 Transmitted PZD

Function code	Word	Value range	Default value
P15.13	Transmitted PZD2	0: Invalid	0
P15.14	Transmitted PZD3	1: Running frequency ( $\times 100$ , Hz)	0
P15.15	Transmitted PZD4	2: Set frequency ( $\times 100$ , Hz)	0
P15.16	Transmitted PZD5	3: Bus voltage ( $\times 10$ , V)	0
P15.17	Transmitted PZD6	4: Output voltage ( $\times 1$ , V)	0
P15.18	Transmitted PZD7	5: Output current ( $\times 10$ , A)	0
P15.19	Transmitted PZD8	6: Actual output torque ( $\times 10$ , %)	0
P15.20	Transmitted PZD9	7: Actual output power ( $\times 10$ , %)	0
P15.21	Transmitted PZD10	8: Rotating speed of the running ( $\times 1$ , RPM)	0
P15.22	Transmitted PZD11	9: Linear speed of the running ( $\times 1$ , m/s)	0
P15.23	Transmitted PZD12	10: Ramp frequency reference 11: Fault code 12: AI1 value ( $\times 100$ , V) 13: AI2 value ( $\times 100$ , V) 14: AI3 value ( $\times 100$ , V) 15: HDIA frequency ( $\times 100$ , kHz) 16: Terminal input state 17: Terminal output state	0



Function code	Word	Value range	Default value
		18: PID reference ( $\times 100$ , %) 19: PID feedback ( $\times 100$ , %) 20: Rated torque of the motor 21: MSB of position reference (signed number) 22: LSB of position reference (unsigned number) 23: MSB of position feedback (signed number) 24: LSB of position feedback (unsigned number) 25: State word 26: HDIB frequency value ( $\times 100$ , kHz)	

## Chapter 4 PROFINET communication card

### 4.1 Overview

1. Thanks for choosing INVT PROFINET communication cards. This manual describes the function specifications, installation, basic operation and settings, and information about the network protocol. To ensure that you install and operate the product properly, read this manual and the communication protocol section in the VFD operation manual carefully before you use the product.
2. This manual only describes how to operate the PROFINET communication card and the related commands but does not provide details about the PROFINET protocol. For more information about the PROFINET protocol, read the related specialized articles or books.
3. This communication card is defined as a PROFINET slave station communication card and is used on a VFD that supports PROFINET communication.
4. The communication card supports the linear network topology and star-shaped network topology.
5. The communication card supports 32 inputs/outputs to read and write process data, read state data, and read and write function parameters of a VFD.

### 4.2 Features

#### 1. Supported functions

- Supports the PROFINET protocol, and supports PROFINET I/O devices
- Provides two PROFINET I/O ports and supports the 100 M full-duplex operation
- Supports the linear network topology and star-shaped network topology.

#### 2. Supported communication types

- Standard Ethernet channels

Standard Ethernet channels are non-realtime communication channels that use the TCP/IP protocol, and are mainly used for device parameterization and configuration and to read diagnosis data.

- Real-time (RT) communication channels

RT channels are optimized channels for real-time communication. They take precedence over TCP (UDP)/IP, which ensures that various stations on a network perform data transmission with high time requirements at a certain interval. The bus period may reach the precision of millisecond. These channels are used to transmit data such as process data and alarm data.

- Isochronous real-time (IRT) communication channels

IRT channels are implemented through the built-in Switch-ASIC IRT chip. IRT

communication can further shorten the processing time of the communication stack software, synchronizing data transmission of the program and device. The transmission delay is less than 1 ms, and the jitter is less than 1  $\mu$ s. The typical application is motion control.

### 3. Communication ports

Standard RJ45 ports are used in PROFINET communication. The communication card provides two RJ45 ports with no transmission direction defined, and therefore you can insert a cable into the port without regard to its direction. Figure 4-1 shows the ports, and Table 4-1 describes the functions of the ports.



Figure 4-1 Two standard RJ45 ports

Table 4-1 Standard RJ45 port pins

Pin	Name	Description
1	TX+	Transmit Data+
2	TX-	Transmit Data-
3	RX+	Receive Data+
4	n/c	Not connected
5	n/c	Not connected
6	RX-	Receive Data-
7	n/c	Not connected
8	n/c	Not connected

### 4. State indicators

The PROFINET communication card provides nine LED indicators to indicate its states.

Table 4-2 describes the state indicators.

Table 4-2 State indicators

LED	Color	State	Description
LED1	Green		3.3 V power indicator
LED2 (Bus state indicator)	Red	On	Not connected through a network cable
		Blinking	Connected to the PROFINET controller through a network cable, but no communication established
		Off	Communication established with the PROFINET controller

LED	Color	State	Description
LED3 (System fault indicator)	Red	On	PROFINET diagnosis enabled
		Off	PROFINET diagnosis disabled
LED4 (Slave ready indicator)	Green	On	TPS-1 communication stack started
		Blinking	TPS-1 waits for the initialization of MCU
		Off	TPS-1 communication stack not started
LED5 (Maintenance state indicator)	Green		Defined by the manufacturer, depending on the characteristics of the device
LED6/7 (Network port state indicator)	Green	On	PROFINET communication card connected to the PC/PLC through a network cable
		Off	PROFINET communication card not connected to the PC/PLC
LED8/9 (Network port communication indicator)	Green	On	PROFINET communication card communicating with the PC/PLC
		Off	PROFINET communication card not communicating with the PC/PLC

### 4.3 Electrical wiring

PROFINET communication card provides standard RJ45 ports and supports the linear network topology and star-shaped network topology. Figure 4-2 and Figure 4-3 show the electrical wiring diagrams.

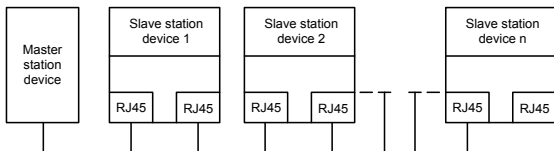

Figure 4-2 Electrical wiring diagram of the linear network topology

**Note:** For the star-shaped network topology, you need to use a PROFINET switch.

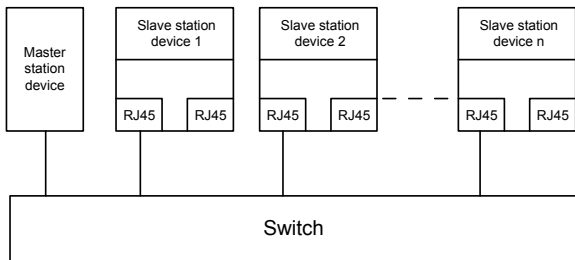

Figure 4-3 Electrical wiring diagram of the star-shaped network topology

## 4.4 Communication

### 4.4.1 Packet format

Table 4-3 describes the structure of an RT frame (non-synchronous).

Table 4-3 Structure of an RT frame

Data header	Ethernet type	VLAN	Ethernet type	Frame identifier	RT user data	Period counter	Data state	Transmission state	FCS
	2 bytes	2 bytes	2 bytes	2 bytes	36–1440 bytes	2 bytes	1 byte	1 byte	4 bytes
	0x8100		0x8892						
	VLAN flag					APDU state			

Data header			
7-byte preamble	1-byte synchronization information	6-byte source MAC address	6-byte destination MAC address

Table 4-4 describes the structure of the IRT frame (synchronous).

Table 4-4 Structure of an IRT frame

Data header				Ethernet type	VLAN	Ethernet type	Frame identifier	IRT user data	FCS
7-byte preamble	1-byte synchronization	6-byte source MAC address	6-byte destination MAC address	2 bytes	2 bytes	2 bytes	2 bytes	36–140 bytes	4 bytes

#### 4.4.2 PROFINET I/O communication

The PROFINET communication card supports 16-word input/output. Figure 4-4 shows the packet format for transmitting data with a VFD.

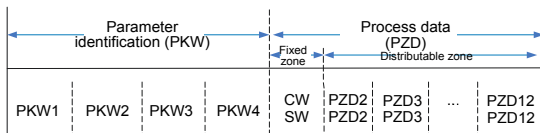

Figure 4-4 Packet structure

By using the 32 inputs/outputs, you can set the reference parameters of the VFD, monitor the state values, transmit control commands, monitor the running state, and read/write the function parameters of the VFD. For specific operations, see the following description.

Parameter zone:

PKW1—Parameter identification

PKW2—Array index number

PKW3—Parameter value 1

PKW4—Parameter value 2

Process data:

CW—Control word (transmitted from the master to a slave. For description, see Table 4-5)

SW—State word (transmitted from a slave to the master. For description, see Table 4-7.)

PZD—Process data (defined by users)

(When the process data is output by the master to a slave, it is a reference value; and when the process data is input by a slave to the master, it is an actual value.)

**PZD zone (process data zone):** The PZD zone in a communication packet is designed for controlling and monitoring a VFD. The master and slave stations always process the received PZD with the highest priority. The processing of PZD takes priority over that of PKW, and the master and slave stations always transmit the latest valid data on the interfaces.

**CWs and SWs**

Using CWs is the basic method of the fieldbus system to control VFDs. A CW is transmitted by the fieldbus master station to a VFD device. In this case, the adapter module functions as a gateway. The VFD device responds to the bit code information of the CW and feeds state information back to the master through an SW.

**Reference value:** A VFD device may receive control information in multiple channels, including

analog and digital input terminals, VFD control panel, and communication modules (such as RS485 and CH-PA01 adapter modules). To enable the control over VFD devices through PROFINET, you need to set the communication module as the controller of the VFD device.

**Actual value:** An actual value is a 16-bit word that includes information about VFD device operation. The monitoring function is defined through VFD parameters. The conversion scale of an integer transmitted as an actual value from the VFD device to the master depends on the set function. For more description, see the related VFD operation manual.

**Note:** A VFD device always checks the bytes of a CW and reference value.

### Task packet (master station -> VFD)

**CW:** The first word in a PZD task packet is a VFD CW. Table 4-5 describes Goodrive350 series VFD CWs.

Table 4-5 Goodrive350 series VFD CWs

Bit	Name	Value	Description
0-7	Communication-based control command	1	Forward running
		2	Reverse running
		3	Forward jogging
		4	Reverse jogging
		5	Stop
		6	Coast to stop (emergency stop)
		7	Fault reset
		8	Stop jogging
8	Enable writing	1	Enable writing (mainly through PKW1 to PKW4)
9-10	Motor group setting	00	Motor 1
		01	Motor 2
11	Control mode switching	1	Enable torque/speed control switching
		0	Disable switching
12	Reset power consumption to zero	1	Enable
		0	Disable
13	Pre-excitation	1	Enable
		0	Disable
14	DC braking	1	Enable
		0	Disable
15	Heartbeat reference	1	Enable
		0	Disable

**Reference value (REF):** The second to twelfth words in a PZD task packet are the main settings. The main frequency settings are provided by the main setting signal source. Table 4-6 describes the settings of Goodrive350 series VFD.

Table 4-6 Settings of Goodrive350 series VFD

Function code	Word	Value range	Default value
P16.32	Received PZD2	0: Invalid 1: Set frequency (0–Fmax, unit: 0.01 Hz)	0
P16.33	Received PZD3	2: PID reference (0–1000, in which 1000 corresponds to 100.0%)	0
P16.34	Received PZD4	3: PID feedback (0–1000, in which 1000 corresponds to 100.0%)	0
P16.35	Received PZD5	4: Torque setting (-3000–+3000, in which 1000 corresponds to 100.0% of the rated current of the motor)	0
P16.36	Received PZD6	5: Setting of the upper limit of forward running frequency (0–Fmax, unit: 0.01 Hz)	0
P16.37	Received PZD7	6: Setting of the upper limit of reverse running frequency (0–Fmax, unit: 0.01 Hz)	0
P16.38	Received PZD8	7: Upper limit of the electromotive torque (0–3000, in which 1000 corresponds to 100.0% of the rated current of the motor)	0
P16.39	Received PZD9	8: Upper limit of the brake torque (0–3000, in which 1000 corresponds to 100.0% of the rated current of the motor)	0
P16.40	Received PZD10	9: Virtual input terminal command, 0x000–0x3FF (corresponding to S8, S7, S6, S5, HDIB, HDIA, S4, S3, S2, and S1 in sequence)	0
P16.41	Received PZD11	10: Virtual output terminal command, 0x00–0x0F (corresponding to RO2, RO1, HDO, and Y1 in sequence)	0
P16.42	Received PZD12	11: Voltage setting (for V/F separation) (0–1000, in which 1000 corresponds to 100.0% of the rated voltage of the motor) 12: AO output setting 1 (-1000–+1000, in which 1000 corresponds to 100.0%) 13: AO output setting 2 (-1000–+1000, in which 1000 corresponds to 100.0%) 14: MSB of position reference (signed number) 15: LSB of position reference (unsigned number) 16: MSB of position feedback (signed number) 17: LSB of position feedback (unsigned number) 18: Position feedback setting flag (position feedback can be set only after this flag is set to 1 and then to 0)	0

**Response packet (VFD -> master station)**

SW: The first word in a PZD response packet is a VFD SW. Table 4-7 describes Goodrive350



series VFD SWs.

Table 4-7 Goodrive350 series VFD SWs

Bit	Name	Value	Description
0-7	Running state	1	In forward running
		2	In reverse running
		3	Stopped
		4	Faulty
		5	POFF
8	Bus voltage established	1	Ready to run
		0	Not ready to run
9-10	Motor group feedback	0	Motor 1
		1	Motor 2
11	Motor type feedback	1	Synchronous motor
		0	Asynchronous motor
12	Overload pre-alarm feedback	1	Overload pre-alarm generated
		0	No overload pre-alarm generated
13-14	Run/Stop mode	0	Keypad-based control
		1	Terminal-based control
		2	Communication-based control
		3	Reserved
15	Heartbeat feedback	1	Heartbeat feedback
		0	No heartbeat feedback

Actual value (ACT): The second to twelfth words in a PZD task packet are the main actual values. The main actual frequency values are provided by the main actual value signal source.

Table 4-8 Actual state values of Goodrive350 series VFD

Function code	Word	Value range	Default value
P16.43	Transmitted PZD2	0: Invalid	0
P16.44	Transmitted PZD3	1: Running frequency ( $\times 100$ , Hz)	0
P16.45	Transmitted PZD4	2: Set frequency ( $\times 100$ , Hz)	0
P16.46	Transmitted PZD5	3: Bus voltage ( $\times 10$ , V)	0
P16.47	Transmitted PZD6	4: Output voltage ( $\times 1$ , V)	0
P16.48	Transmitted PZD7	5: Output current ( $\times 10$ , A)	0
P16.49	Transmitted PZD8	6: Actual output torque ( $\times 10$ , %)	0
P16.50	Transmitted PZD9	7: Actual output power ( $\times 10$ , %)	0
P16.51	Transmitted PZD10	8: Rotating speed of the running ( $\times 1$ , RPM)	0
P16.52	Transmitted PZD11		0

Function code	Word	Value range	Default value
P16.53	Transmitted PZD12	9: Linear speed of the running ( $\times 1$ , m/s) 10: Ramp frequency reference 11: Fault code 12: AI1 value ( $\times 100$ , V) 13: AI2 value ( $\times 100$ , V) 14: AI3 value ( $\times 100$ , V) 15: HDIA frequency ( $\times 100$ , kHz) 16: Terminal input state 17: Terminal output state 18: PID reference ( $\times 100$ , %) 19: PID feedback ( $\times 100$ , %) 20: Rated torque of the motor 21: MSB of position reference (signed number) 22: LSB of position reference (unsigned number) 23: MSB of position feedback (signed number) 24: LSB of position feedback (unsigned number) 25: State word 26: HDIB frequency value ( $\times 100$ , kHz)	0

### PKW zone

PKW zone (parameter identification flag PKW1—numerical zone): The PKW zone describes the processing mode of the parameter identification interface. A PKW interface is not a physical interface but a mechanism that defines the transmission mode (such reading and writing a parameter value) of a parameter between two communication ends.

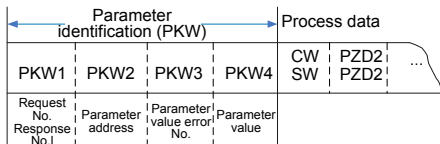

Figure 4-5 Parameter identification zone

In the periodic communication, the PKW zone consists of four 16-bit words. The following table describes the definition of each word.

First word PKW1 (16 bits)		
Bits 15–00	Task or response identification flag	0–7
Second word PKW2 (16 bits)		
Bits 15–00	Basic parameter address	0–247
Third word PKW3 (16 bits)		
Bits 15–00	Value (most significant word) of a parameter or error code of the returned value	00
Fourth word PKW4 (16 bits)		
Bits 15–00	Value (least significant word) of a parameter	0–65535

**Note:** If the master station requests the value of a parameter, the values in PKW3 and PKW4 of the packet that the master station transmits to the VFD are no longer valid.

Task request and response: When transmitting data to a slave, the master uses a request number, and the slave uses a response number to accept or reject the request.

Table 4-9 Task identification flag PKW1

Request No. (from the master to a slave)		Response signal	
Request No.	Function	Acceptance	Rejection
0	No task	0	—
1	Requesting the value of a parameter	1, 2	3
2	Modifying a parameter value (one word) [modifying the value only on RAM]	1	3 or 4
3	Modifying a parameter value (two words) [modifying the value only on RAM]	2	3 or 4
4	Modifying a parameter value (one word) [modifying the value on both RAM and EEPROM]	1	3 or 4
5	Modifying a parameter value (two words) [modifying the value on both RAM and EEPROM]	2	3 or 4

**Note:** The requests #2, #3, and #5 are not supported currently.

Table 4-10 Response identification flag PKW1

Response No. (from a slave to the master)	
Response No.	Function
0	No response
1	Transmitting the value of a parameter (one word)
2	Transmitting the value of a parameter (two words)
3	The task cannot be executed and one of the following error number is returned: 1: Invalid command 2: Invalid data address

<b>Response No. (from a slave to the master)</b>	
<b>Response No.</b>	<b>Function</b>
	3: Invalid data value 4: Operation failure 5: Password error 6: Data frame error 7: Parameter read only 8: Parameter cannot be modified during VFD running 9: Password protection

## Chapter 5 EtherNet/IP communication card

### 5.1 Overview

1. Thanks for choosing INVT EtherNet/IP communication cards. This manual describes the function specifications, installation, basic operation and settings, and information about the network protocol. To ensure that you install and operate the product properly, read this manual and the communication protocol section in the VFD operation manual carefully before you use the product.
2. This manual only describes how to operate the EtherNet/IP communication card and the related commands but does not provide details about the EtherNet/IP protocol. For more information about the EtherNet/IP protocol, read the related specialized articles or books.
3. This communication card is defined as an EtherNet/IP slave station communication card and is used on a VFD that supports EtherNet/IP communication.
4. The communication card supports the star, linear, and ring topologies.
5. The communication card supports 32 inputs/outputs to read and write process data, read state data, and read and write function parameters of a VFD.

### 5.2 Features

#### 1. Supported functions

- Supports the EtherNet/IP protocol, and supports EtherNet/IP devices.
- Provides two EtherNet/IP ports and supports the 10/100M full-duplex/half-duplex operation.
- Supports the star, linear, and ring topologies (but does not support ring-network monitoring).

#### 2. Supported communication types

EtherNet/IP adapts the application layer protocol CIP, which is also used by DeviceNet and ControlNet. Therefore, they use the same object library and consistent industrial specifications.

CIP uses non-connected UDP/IP and connection-based TCP/IP for information control and transmission over the Ethernet, allowing the sending of explicit and implicit packets. Implicit packets are time-critical control messages and transmitted using UDP/IP. Explicit packets are point-to-point messages that are not time critical and transmitted using TCP/IP. Explicit packets are used for configuration, download, and fault diagnosis, while implicit packets are used for real-time I/O data transmission.

#### 3. Communication ports

Standard RJ45 ports are used in EtherNet/IP communication. The communication card provides two RJ45 ports with no transmission direction defined, and therefore you can insert a

cable into the port without regard to its direction. Figure 5-1 shows the ports, and Table 5-1 describes the port pins.

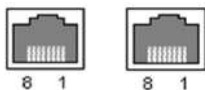

Figure 5-1 Two standard RJ45 ports

Table 5-1 Standard RJ45 port pins

Pin	Name	Description
1	TX+	Transmit Data+
2	TX-	Transmit Data-
3	RX+	Receive Data+
4	n/c	Not connected
5	n/c	Not connected
6	RX-	Receive Data-
7	n/c	Not connected
8	n/c	Not connected

#### 4. State indicators

The EtherNet/IP communication card provides four LED indicators and four net port indicators to indicate its states. Table 5-2 describes the state indicators.

Table 5-2 State indicators

LED	Color	State	Description
LED1	Green	On	The card is shaking hands with the VFD.
		Blinking (1Hz)	The card and VFD communicate normally.
		Off	The card and VFD communicate improperly.
LED2	Green	On	The communication between the card and PLC is online and data interchange is allowed.
		Blinking (1Hz)	IP address conflict between the card and PLC.
		Off	The communication between the card and PLC is offline.
LED3	Red	On	Failed to set up I/O between the card and PLC.
		Blinking (1Hz)	Incorrect PLC configuration.
		Blinking (2Hz)	The card failed to send data to the PLC.
		Blinking (4Hz)	The connection between the card and PLC timed out.
		Off	No fault.
LED4	Red	On	3.3V power indicator.

LED	Color	State	Description
Net port indicator	Yellow	On	Link indicator, indicating successful Ethernet connection.
		Off	Link indicator, indicating Ethernet connection not established.
Net port indicator	Green	On	ACK indicator, indicating data interchange being performed.
		Off	ACK indicator, indicating data interchange not be performed.

### 5.3 Electrical wiring

The EtherNet/IP communication card provides standard RJ45 ports and supports the linear, star, and ring topologies. Figure 5-2, Figure 5-3, and Figure 5-4 show the electrical wiring diagrams for different topologies.

Use CAT5, CAT5e, and CAT6 network cables for electrical wiring. When the communication distance is greater than 50 meters, use high-quality network cables that meet the national standards.

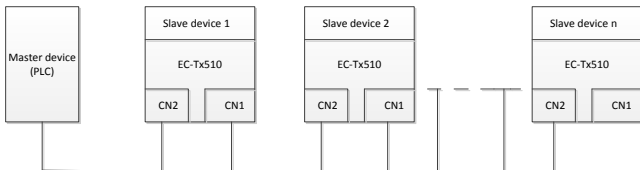

Figure 5-2 Electrical wiring diagram for a linear topology

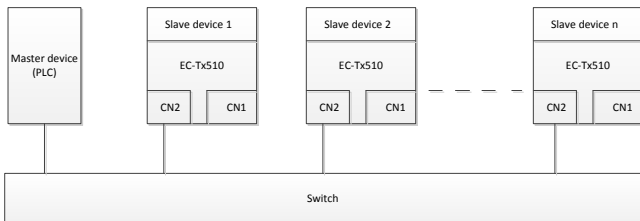

Figure 5-3 Electrical wiring diagram for a star topology

**Note:** An Ethernet switch must be available when the star topology is used.

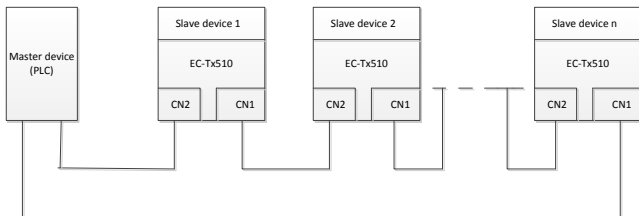

Figure 5-4 Electrical wiring diagram for a ring network

## 5.4 Communication

### 5.4.1 Communication settings

The EtherNet/IP communication card can function as only the EtherNet/IP slave station. Before communication, set Goodrive350 function codes, including:

1. IP address and subnet mask for the card

The default IP address and subnet mask for each communication card are 192.168.0.1 and 255.255.255.0. You can change them to the address of a network segment.

2. Control mode

If you want to control the VFD with the communication card, set the control mode to EtherNet/IP communication control. To be specific, set P00.01=2 (communication as the running command channel) and set P00.02=3 (EtherNet/IP communication channel) to control VFD start and stop. If you want to set a value through EtherNet/IP communication, change the control way of corresponding function codes to EtherNet/IP communication. Appendix B lists related function codes.

**Note:** After the setting, the card can communicate normally. If you want to control the VFD with the card, set related function codes to enable EtherNet/IP communication control.

### 5.4.2 Packet format

Table 5-3 describes the structure of a TCP communication packet.

Table 5-3 Structure of a TCP communication packet

MAC-layer packet header	IP-layer packet header	TCP-layer packet header	Valid data	Packet trailer
14 bytes	20 bytes	20 bytes	0–1488 bytes	4 bytes

Table 5-4 describes the structure of a UDP communication packet.



Table 5-4 Structure of a UDP communication packet

MAC-layer packet header	IP-layer packet header	UDP-layer packet header	Valid data	Packet trailer
14 bytes	20 bytes	20 bytes	0-1488 bytes	4 bytes

### 5.4.3 EtherNet/IP communication

The EtherNet/IP communication card supports 16-word input/output. Figure 5-5 shows the packet format for transmitting data with a VFD.

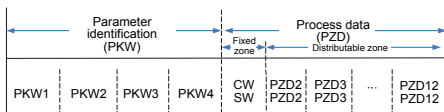

Figure 5-5 Packet structure

By using the 32 inputs/outputs, you can set the reference parameters of the VFD, monitor the state values, transmit control commands, monitor the running state, and read/write the function parameters of the VFD. For specific operations, see the following description.

Parameter zone:

PKW1—Parameter identification

PKW2—Array index number

PKW3—Parameter value 1

PKW4—Parameter value 2

Process data:

CW—Control word (transmitted from the master to a slave. For description, see Table 5-5.)

SW—State word (transmitted from a slave to the master. For description, see Table 5-8.)

PZD—Process data (user defined)

(The process data output from the master to a slave is a reference value, and the process data input from a slave to the master is an actual value.)

PZD zone (process data zone): The PZD zone in a communication packet is designed for controlling and monitoring a VFD. The master and slave stations always process the received PZD with the highest priority. The processing of PZD takes priority over that of PKW, and the master and slave stations always transmit the latest valid data on the interfaces.

CWs and SWs

Using CWs is the basic method of the fieldbus system to control VFDs. A CW is transmitted by the fieldbus master station to a VFD device. In this case, the adapter module functions as a gateway. The VFD device responds to the bit code information of the CW and feeds state information back to the master through an SW.

Reference value: A VFD device may receive control information in multiple channels, including analog and digital input terminals, VFD control panel, and communication modules (such as RS485 and CH-PA01 adapter modules). To enable the control over VFD devices through EtherNet/IP, you need to set the communication module as the controller of the VFD device.

Actual value: An actual value is a 16-bit word that includes information about VFD device operation. The monitoring function is defined through VFD parameters. The conversion scale of an integer transmitted as an actual value from the VFD device to the master depends on the set function. For more description, see the related VFD operation manual.

**Note:** A VFD device always checks the bytes of a CW and reference value.

#### Task packet (master station -> VFD)

CW: The first word in a PZD task packet is a VFD CW. When P16.56=0, EtherNet/IP control words are defined by byte. Table 5-5 describes Goodrive350 series VFD CWs defined by byte.

Table 5-5 Goodrive350 series VFD CWs defined by byte

Bit	Name	Value	Description
0-7	Communication-based control command	1	Run forward
		2	Run reversely
		3	Jog forward
		4	Jog reversely
		5	Stop
		6	Coast to stop (in emergency)
		7	Reset faults
		8	Stop jogging
8	Enabling writing	1	Enable writing (mainly through PKW1 to PKW4)
9-10	Motor group setting	00	MOTOR GROUP 1 SELECTION (Select motor 1)
		01	MOTOR GROUP 2 SELECTION (Select motor 2)
11	Control mode switching	1	Enable torque/speed control switching
		0	Disable switching
12	Resetting power consumption to zero	1	Enable
		0	Disable
13	Pre-excitation	1	Enable

Bit	Name	Value	Description
		0	Disable
14	DC braking	1	Enable
		0	Disable
15	Heartbeat reference	1	Enable
		0	Disable

When P16.56=1, EtherNet/IP control words are defined by bit. Table 5-6 describes Goodrive350 series VFD CWs defined by bit.

Table 5-6 Goodrive350 series VFD CWs defined by bit

Bit	Name	Value	Description	Remarks
0	Bit 0 of a communication-based control command	0	Decelerate to stop	No action: 0x03 Decelerate to stop: 0x00 Run forward: 0x01 Run reversely: 0x02 Fault reset: 0x04 Coast to stop: 0x08 Forward jogging: 0x10 Jog reversely: 0x20 Stop jogging: 0x40
		1	Run forward	
1	Bit 1 of a communication-based control command	0	Decelerate to stop	
		1	Run reversely	
2	Bit 2 of a communication-based control command	0	None	
		1	Reset faults	
3	Bit 3 of a communication-based control command	0	None	
		1	Coast to stop (in emergency)	
4	Bit 4 of a communication-based control command	0	None	
		1	Jog forward	
5	Bit 5 of a communication-based control command	0	None	
		1	Jog reversely	
6	Bit 6 of a communication-based control command	0	None	
		1	Stop jogging	
7	Bit 7 of a communication-based control command	0	None	
		1	None	
8	Enabling writing	1	Enable writing (mainly through PKW1– PKW4)	
9–10	Motor group setting	00	MOTOR GROUP 1 SELECTION (Select motor 1)	
		01	MOTOR GROUP 2 SELECTION (Select motor 2)	

Bit	Name	Value	Description	Remarks
11	Control mode switching	1	Enable torque/speed control switching	
		0	Disable switching	
12	Resetting power consumption to zero	1	Enable	
		0	Disable	
13	Pre-excitation	1	Enable	
		0	Disable	
14	DC braking	1	Enable	
		0	Disable	
15	Heartbeat reference	1	Enable	
		0	Disable	

Reference value (REF): The second to twelfth words in a PZD task packet are the main settings. The main frequency settings are provided by the main setting signal source. Table 5-7 describes the settings of Goodrive350 series VFD.

Table 5-7 Settings of Goodrive350 series VFD

Function code	Word	Value range	Default value
P16.32	Received PZD2	0: Invalid	0
P16.33	Received PZD3	1: Set frequency (0–Fmax, unit: 0.01 Hz)	
P16.34	Received PZD4	2: PID reference (0–1000, in which 1000 corresponds to 100.0%)	0
P16.35	Received PZD5	3: PID feedback (0–1000, in which 1000 corresponds to 100.0%)	
P16.36	Received PZD6	4: Torque setting (-3000–+3000, in which 1000 corresponds to 100.0% of the rated current of the motor)	0
P16.37	Received PZD7	5: Setting of the upper limit of forward running frequency (0–Fmax, unit: 0.01 Hz)	
P16.38	Received PZD8	6: Setting of the upper limit of reverse running frequency (0–Fmax, unit: 0.01 Hz)	0
P16.39	Received PZD9	7: Upper limit of the electromotive torque (0–3000, in which 1000 corresponds to 100.0% of the rated current of the motor)	
P16.40	Received PZD10	8: Upper limit of the brake torque (0–3000, in which 1000 corresponds to 100.0% of the rated current of the motor)	0
P16.41	Received PZD11	9: Virtual input terminal command, 0x000–0x3FF (corresponding to S8, S7, S6, S5, HDIB, HDIA, S4, S3, S2, and S1 in sequence)	
P16.42	Received PZD12	10: Virtual output terminal command, 0x00–0x0F (corresponding to RO2, RO1, HDO, and Y1 in sequence)	0
		11: Voltage setting (for V/F separation)	

Function code	Word	Value range	Default value
		(0–1000, in which 1000 corresponds to 100.0% of the rated voltage of the motor) 12: AO output setting 1 (-1000→+1000, in which 1000 corresponds to 100.0%) 13: AO output setting 2 (-1000→+1000, in which 1000 corresponds to 100.0%) 14: MSB of position reference (signed number) 15: LSB of position reference (unsigned number) 16: MSB of position feedback (signed number) 17: LSB of position feedback (unsigned number) 18: Position feedback setting flag (position feedback can be set only after this flag is set to 1 and then to 0)	

### Response packet (VFD → master station)

SW: The first word in a PZD response packet is a VFD SW. When P16.56=0, EtherNet/IP control words are defined by byte. Table 5-8 describes Goodrive350 series VFD SWs defined by byte.

Table 5-8 Goodrive350 series VFD SWs defined by byte

Bit	Name	Value	Description
0–7	Running state	1	In forward running
		2	In reverse running
		3	Stopped
		4	Faulty
		5	POFF
8	Bus voltage establishment	1	Ready to run
		0	Not ready to run
9–10	Motor group feedback	0	Motor 1
		1	Motor 2
11	Motor type feedback	1	Synchronous motor
		0	Asynchronous motor
12	Overload alarm feedback	1	Overload alarm generated
		0	No overload alarm generated
13–14	RUN/STOP MODE (Run/Stop mode)	0	Keypad-based control
		1	Terminal-based control
		2	Communication-based control
		3	Reserved
15	HEARTBEAT FEEDBACK (Heartbeat feedback)	1	Heartbeat feedback
		0	No heartbeat feedback

When P16.56=1, EtherNet/IP control words are defined by bit. Table 5-9 describes Goodrive350 series VFD SWs defined by bit.

Table 5-9 Goodrive350 series VFD SWs defined by bit

Bit	Name	Value	Description
0	Bit 0 of running state	0	None
		1	In forward running
1	Bit 1 of running state	0	None
		1	In reverse running
2	Bit 2 of running state	0	None
		1	Stopped
3	Bit 3 of running state	0	None
		1	Faulty
4	Bit 4 of running state	0	None
		1	POFF
5	Bit 5 of running state	0	None
		1	Pre-exciting
6	Bit 6 of running state	None	None
7	Bit 7 of running state	None	None
8	Bus voltage establishment	1	Ready to run
		0	Not ready to run
9–10	Motor group feedback	0	Motor 1
		1	Motor 2
11	Motor type feedback	1	Synchronous motor
		0	Asynchronous motor
12	Overload alarm feedback	1	Overload alarm generated
		0	No overload alarm generated
13–14	RUN/STOP MODE (Run/Stop mode)	0	Keypad-based control
		1	Terminal-based control
		2	Communication-based control
		3	Reserved
15	Heartbeat feedback	1	Heartbeat feedback
		0	No heartbeat feedback

Actual value (ACT): The second to twelfth words in a PZD task packet are the main actual values. The main actual frequency values are provided by the main actual value signal source.

Table 5-10 Actual state values of Goodrive350 series VFD

Function code	Word	Value range	Default value
P16.43	Transmitted	0: Invalid	0

Function code	Word	Value range	Default value
	PZD2	1: Running frequency ( $\times 100$ , Hz)	
P16.44	Transmitted PZD3	2: Set frequency ( $\times 100$ , Hz)	0
P16.45	Transmitted PZD4	3: Bus voltage ( $\times 10$ , V)	0
P16.46	Transmitted PZD5	4: Output voltage ( $\times 1$ , V)	0
P16.47	Transmitted PZD6	5: Output current ( $\times 10$ , A)	0
P16.48	Transmitted PZD7	6: Actual output torque ( $\times 10$ , %)	0
P16.49	Transmitted PZD8	7: Actual output power ( $\times 10$ , %)	0
P16.50	Transmitted PZD9	8: Rotating speed ( $\times 1$ , RPM)	0
P16.51	Transmitted PZD10	9: Linear speed ( $\times 1$ , m/s)	0
P16.52	Transmitted PZD11	10: Ramp frequency reference	0
P16.53	Transmitted PZD12	11: Fault code	0
		12: AI1 value ( $\times 100$ , V)	
		13: AI2 value ( $\times 100$ , V)	
		14: AI3 value ( $\times 100$ , V)	
		15: HDIA frequency ( $\times 100$ , kHz)	
		16: Terminal input state	
		17: Terminal output state	
		18: PID reference ( $\times 100$ , %)	
		19: PID feedback ( $\times 100$ , %)	
		20: Motor rated torque	
		21: MSB of position reference (signed number)	
		22: LSB of position reference (unsigned number)	
		23: MSB of position feedback (signed number)	
		24: LSB of position feedback (unsigned number)	
		25: State word	
		26: HDIB frequency value ( $\times 100$ , kHz)	

### PKW zone

PKW zone (parameter identification flag PKW1—numerical zone): The PKW zone describes the processing mode of the parameter identification interface. A PKW interface is not a physical interface but a mechanism that defines the transmission mode (such reading and writing a parameter value) of a parameter between two communication ends.

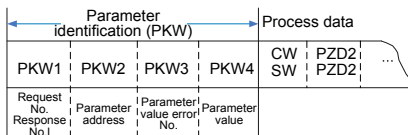

Figure 5-6 Parameter identification zone

In periodic communication, the PKW zone consists of four 16-bit words. The following table describes the words.

First word PKW1 (16 bits)		
Bits 15–00	Task or response identification flag	0–7
Second word PKW2 (16 bits)		
Bits 15–00	Basic parameter address	0–247
Third word PKW3 (16 bits)		
Bits 15–00	Value (most significant word) of a parameter or error code of the returned value	00
Fourth word PKW4 (16 bits)		
Bits 15–00	Value (least significant word) of a parameter	0–65535

**Note:** If the master station requests the value of a parameter, the values in PKW3 and PKW4 of the packet that the master station transmits to the VFD are no longer valid.

Task request and response: When transmitting data to a slave, the master uses a request number, and the slave uses a response number to accept or reject the request.

Table 5-11 Task identification flag PKW1

Request No. (from the master to a slave)		Response signal	
Request No.	Function	Acceptance	Rejection
0	No task	0	—
1	Requesting the value of a parameter	1, 2	3
2	Modifying a parameter value (one word) [modifying the value only on RAM]	1	3 or 4
3	Modifying a parameter value (two words) [modifying the value only on RAM]	2	3 or 4
4	Modifying a parameter value (one word) [modifying the value on both RAM and EEPROM]	1	3 or 4
5	Modifying a parameter value (two words) [modifying the value on both RAM and EEPROM]	2	3 or 4

**Note:** Requests 2, 3, and 5 are not supported currently.

Table 5-12 Response identification flag PKW1

Response No. (from a slave to the master)	
Response No.	Function
0	No response
1	Transmitting the value of a parameter (one word)
2	Transmitting the value of a parameter (two words)



3	<p>The task cannot be executed and one of the following error number is returned:</p> <p>1: Invalid command          2: Invalid data address          3: Invalid data value          4: Operation failure          5: Password error          6: Data frame error          7: Parameter read only          8: Parameter cannot be modified during VFD running          9: Password protection</p>
---	---

#### 5.4.4 Communication with the PLC

The following describes how the PLC (1769\_L36ERMS) communicates with the EtherNet/IP adapter module (using Studio 5000 as the configuration tool).

1. Obtain the EDS file of the EtherNet/IP communication card.

The EDS file is used to specify device properties on the EtherNet/IP client. The client uses the product code, device type, and main version to identify a device.

You can request the EDS file from your supplier or download the file **GD350\_EthernetIP\_V1.10.eds** from [www.invt.com](http://www.invt.com).

2. Use Studio 5000 to add the EDS file to the PLC.

Open Studio 5000, right-click **TOOLS**, and choose **EDS Hardware Installation Tool**.

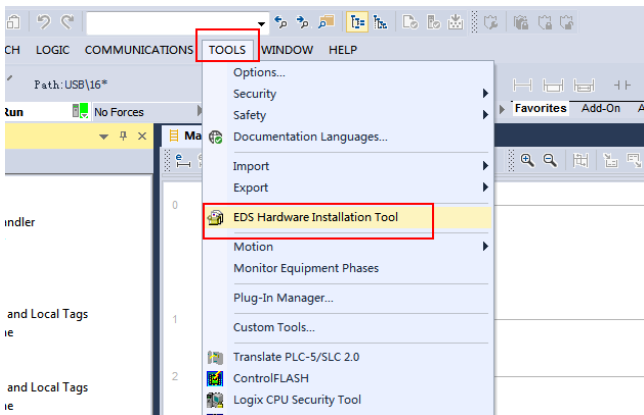

Click **Register an EDS file(s)** and then **Next** in the window that appears.

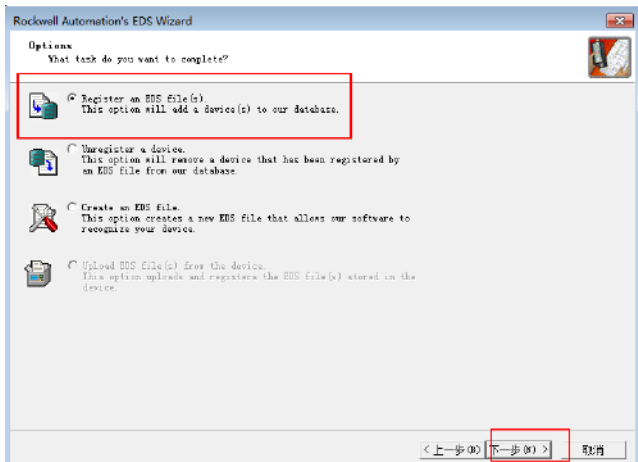

Select the EDS file and click **Next**.



Click **Next**. After the EDS file is registered successfully, the device can be used in the PLC project.

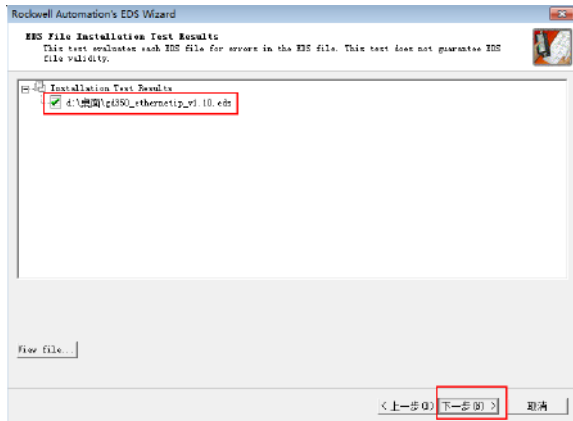

3. Perform configuration on the RSLinx.

Open the RSLinx, as shown in the following figure.

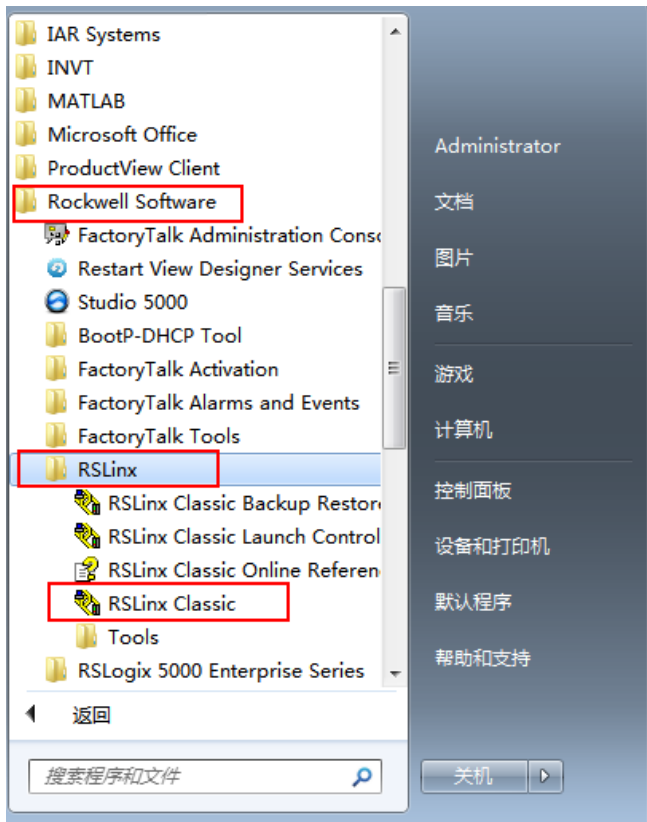

From the menu, choose **Communications > Configure Drivers**.

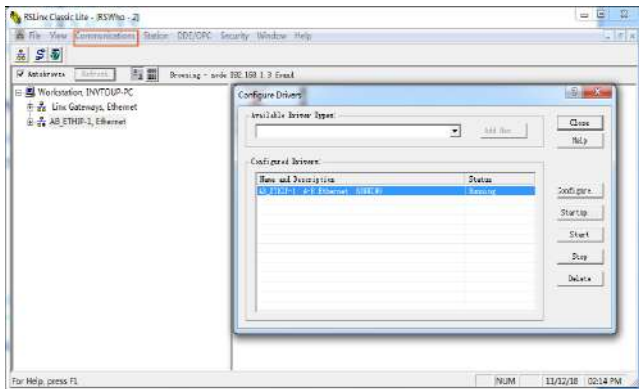

In the **Configure Drivers** window that appears, choose **EtherNet/IP Driver** from the **Available Driver Types** drop-down list box, and click **Add New**. Click **OK** in the **Add New RSLinx Classic Driver** window that appears.

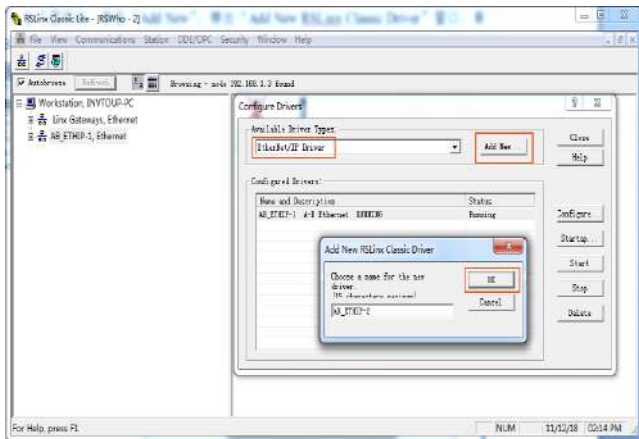

In the **Configure driver** window that appears, select the computer network adapter, and click **OK**.

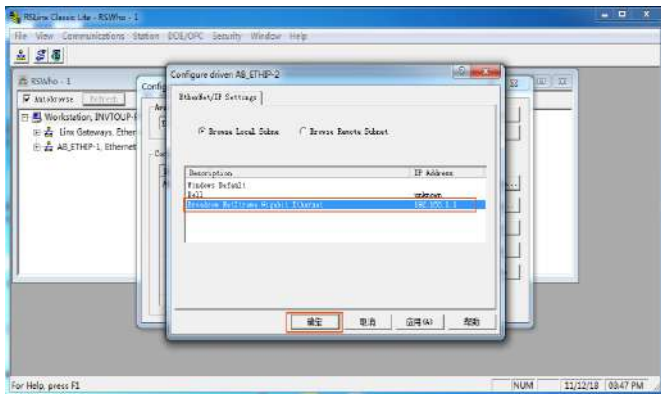

Click the RSWHo icon at the upper left corner. Under the **AB\_ETHIP-2, Ethernet** node, there are PLC parameters, as shown in the following figure.

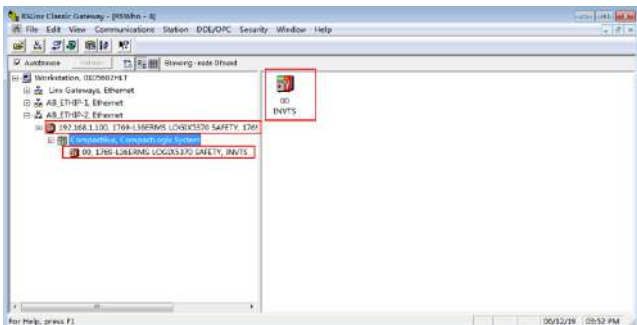

Configuration on the RSLinx is complete.

4. Perform configuration on Studio 5000.  
Open Studio 5000, right-click **File**, and choose **New**.

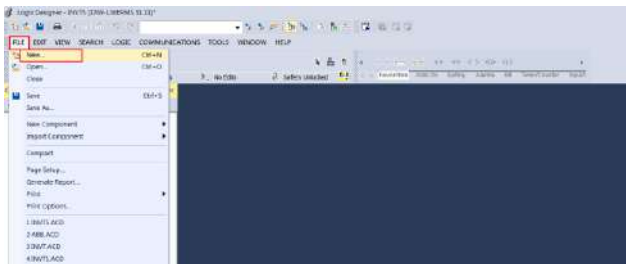

Select the correct PLC number, enter a project name, and click **Next**.

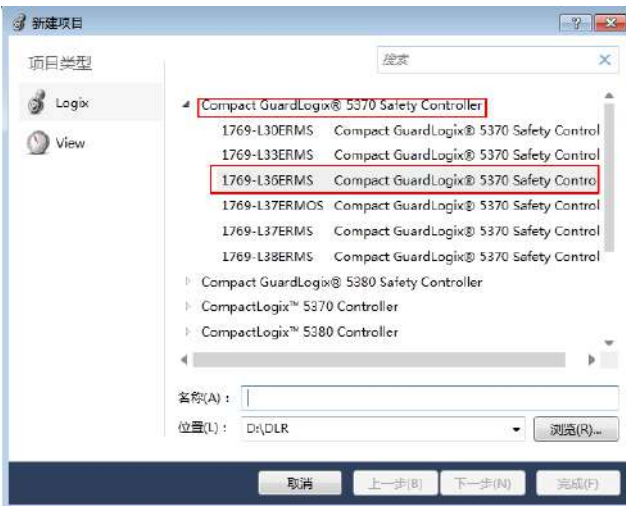

Expand **IO Configuration**, right-click **Ethernet**, and choose **New Module**.



Select **ETHERNET-MODULE** and then click **Create**.

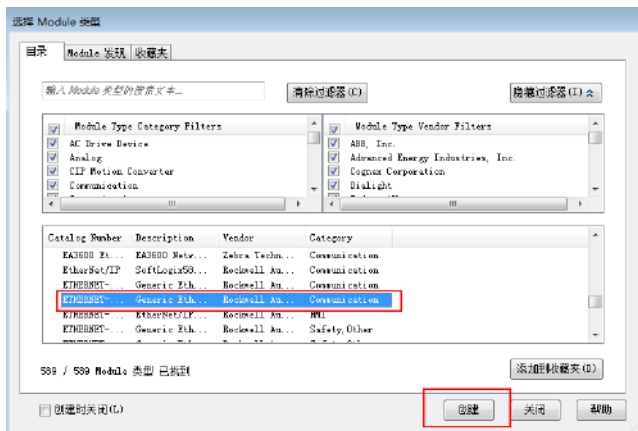

Perform configuration in the window that appears. You can set **Name** and **IP** based on the actual situation, but you must use the settings shown in the following figure for **Connection Parameters**.



General Connection Module Info

Type: ETHERNET-MODULE Generic Ethernet Module  
 Vendor: Rockwell Automation/Allen-Bradley  
 Parent: Local  
 Name: INVT1  
 Description:  
 Comm Format: Data - INT  
 Address / Host Name  
 IP Address: 192 . 168 . 1 . 8  
 Host Name:  
 Status: Offline

Connection Parameters

Input:	Assembly Instance:	Size:
100	16	(16-bit)
150	16	(16-bit)
Configuration: 1	0	(8-bit)

Status Input:    
 Status Output:

OK Cancel Apply Help

On the **Connection** tab, set the requested packet interval to 50ms. If you want to use unicast connection, select **Use Unicast Connection over EtherNet/IP**. Click **OK**.

The slave module is created successfully.

General Connection Module Info

Requested Packet Interval (RPI): 50.0 ms (1.0 - 3200.0 ms)

Inhibit Module  
 Major Fault On Controller If Connection Fails While in Run Mode  
 Use Unicast Connection over EtherNet/IP

Module Fault

Status: Offline

OK Cancel Apply Help

**Note:** Set the slave module number according to the actual slave data. (You are not recommended to create more than 32 slave stations.)

## 5. Perform ring network configuration.

The following describes how to implement a ring network between the PLC and EtherNet/IP communication card. After device installation in the ring network, at least one monitoring node must be configured. You can perform configuration on Studio 5000.

**Note:** The EtherNet/IP communication card does not support the ring network monitoring function.

You need to use the PLC with the ring networking capability and at least two EtherNet/IP communication cards (the suggested number is 32 at most in a DLR ring network). For details about the connection method, see Figure 5-4 Electrical wiring diagram for a ring network.

**Note:** The PLC communicates with upper monitoring software by using the USB cable.

The configuration on the RSLinx and Studio software is similar to that described in the preceding steps.

Assume that projects have been created, as shown in the following figure.

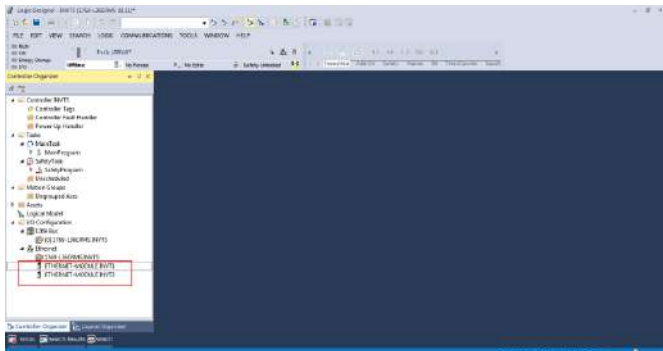

Download projects to the PLC. Enable the PLC online and start the programming mode for it.

In **I/O Configuration**, double-click the module. In the **Controller Properties** window, click the **Network** tab, choose **Enable Supervisor Mode**, and then click **OK**.

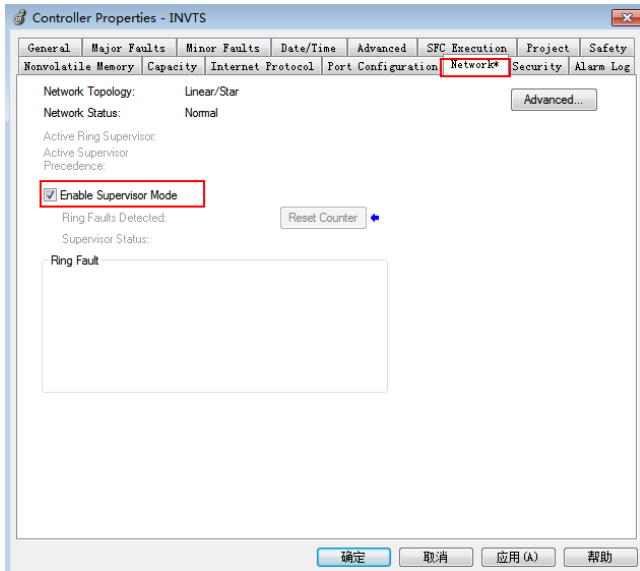

**Note:** The ring network monitoring function can be used only when the PLC is in programming mode.

Click **Advanced...** and then set DLR parameters (such as **Beacon Interval** and **Beacon Timeout**) in the window that appears.

Note: When there are four or less EtherNet/IP slaves, you are recommended to set **Beacon Interval** to 400 $\mu$ s and **Beacon Timeout** to 4000 $\mu$ s. When there are ten or less but more than four EtherNet/IP slaves, you are recommended to set **Beacon Interval** to 6000 $\mu$ s and **Beacon Timeout** to 18000 $\mu$ s. Set parameters depending on the actual situation.

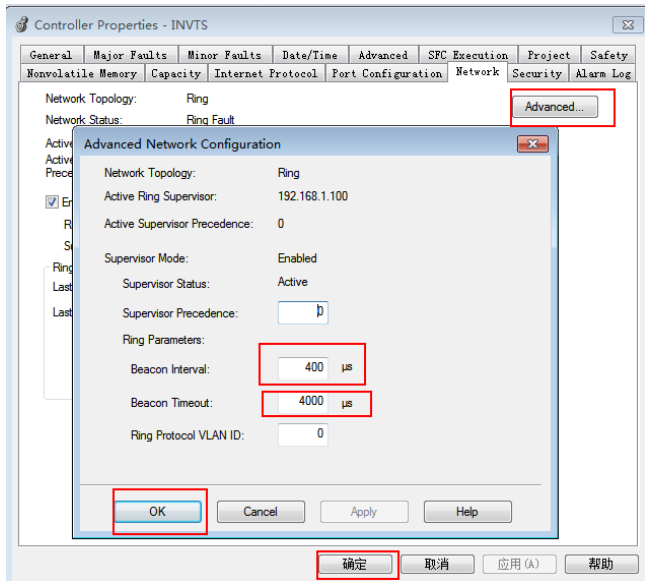

Check on Studio 5000. Ensure that each communication card is normal. If a communication card is abnormal, a warning icon is displayed, as shown in the following figure.

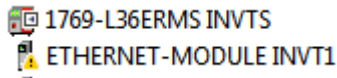

## Chapter 6 EtherCAT communication card

### 6.1 Overview

1. Thanks for choosing INVT EC-TX508 communication cards. This manual describes the function specifications, installation, basic operation and settings, and information about the EtherCAT protocol. To ensure that you install and operate the product properly, read this manual and the communication protocol section in the VFD operation manual carefully before you use the product.
2. This manual only describes how to operate the EC-TX508 communication card and the related commands but does not provide details about the EtherCAT protocol. For more information about the EtherCAT protocol, read the related specialized articles or books.
3. EC-TX508 communication card is defined as an EtherCAT slave station communication card and is used on a VFD that supports EtherCAT communication.
4. The EtherCAT communication of this communication card supports two types of process data for reading data from and writing data to VFDs. They are PDOs (process data objects) and SDOs (service data objects) for reading data from and writing data to the object dictionary defined by the manufacturer.

### 6.2 Features

#### 1. Supported functions

- Supports the EtherCAT COE 402 protocol.
- Supports automatic network address setting

#### 2. Supported services

- Supports the PDO service
- Supports the SDO service
- Supports the object dictionary defined by the manufacturer
- Allowing SDOs to read data from and write data to VFD function codes

#### 3. Supported EtherCAT synchronization cycle

Table 6-1 Supported synchronization cycle

Item	Supported specification
Synchronization cycle	250us
	500us
	1ms
	2ms

#### 4. Communication ports

Standard RJ45 ports are used in EtherCAT communication. The communication card provides two RJ45 ports with transmission direction defined. Figure 6-1 shows the ports. IN (indicating input) and OUT (indicating output) are EtherCAT wiring network ports. Table 6-2 describes the port pins.

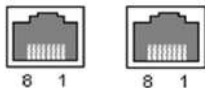

Figure 6-1 RJ45 ports

Table 6-2 RJ45 port pins

Pin	Name	Description
1	TX+	Transmit Data+
2	TX-	Transmit Data-
3	RX+	Receive Data+
4	n/c	Not connected
5	n/c	Not connected
6	RX-	Receive Data-
7	n/c	Not connected
8	n/c	Not connected

#### 5. State indicators

The EtherCAT communication card provides four LED indicators and four net port indicators to indicate its states. Table 6-3 describes the state indicators.

Table 6-3 State indicators

Item	Color	Function description
RUN	Green	The green indicator indicates EtherCAT running state. Init state: It remains off. Pre-OP state: It blinks off 0.2s and on 0.2s. Safe-OP state: It blinks off 1s and on 0.2s. OP state: It remains on.
ALM	Red	The red indicator indicates EtherCAT fault state. No fault: It remains off. Init or Pre-OP state: It blinks off 0.2s and on 0.2s. Safe-OP fault state: It blinks off 1s and on 0.2s. OP fault state: It remains on.

Item	Color	Function description
PWR	Red	3.3V power indicator
Net port indicator (IN)	Yellow	Off: Indicates that Ethernet connection is not established. On: Indicates that Ethernet connection is established successfully.
	Green	Off: Without connection On: With connection but inactive Blinks: With connection and active
Net port indicator (OUT)	Yellow	Off: Indicates that Ethernet connection is not established. On: Indicates that Ethernet connection is established successfully.
	Green	Off: Without connection On: With connection but inactive Blinks: With connection and active

### 6.3 Electrical wiring

The EtherCAT network usually consists of a master station (PLC) and several slave stations (drives or bus extension terminals). Each EtherCAT slave station are configured with two standard Ethernet interfaces, and the electrical wiring diagram is shown in Figure 6-2.

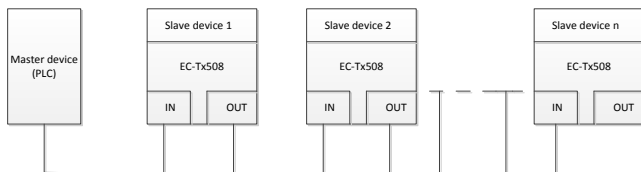

Figure 6-2 Electrical wiring diagram for a linear topology

## 6.4 Communication

### 6.4.1 CoE reference model

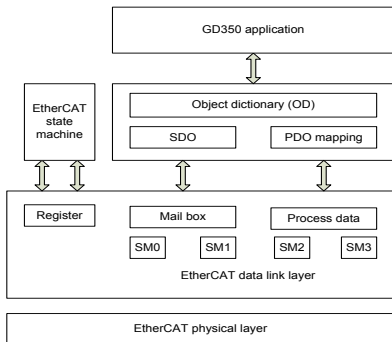

Figure 6-3 CoE reference model

CoE network reference model consists of the data link layer and application layer. The data link layer is responsible for EtherCAT communication protocol. CANopen drive Profile (DS402) communication rules are embedded in the application layer. The object dictionary in CoE includes the parameters, application data, and PDO mapping configuration information.

PDOs are composed of the objects (in the object dictionary) that can perform PDO mapping. The content in PDO data is defined by PDO mapping. PDO data is periodically read and written, which does not require searching the object dictionary. Mail box communication (SDO) is not periodic, which requires searching the object dictionary.

Note: To parse SDO and PDO data correctly on the EtherCAT data link layer, it is necessary to configure FMMU and Sync Manager (SM).

Table 6-4 EtherCAT Sync Manager configuration

Synchronization management	Configuration	Size	Start address
Sync Manager 0	Assigned to receive SDO	512byte	0x1000
Sync Manager 1	Assigned to send SDO	512byte	0x1400
Sync Manager 2	Assigned to receive PDO	128byte	0x1800
Sync Manager 3	Assigned to send PDO	128byte	0x1C00



### 6.4.2 EtherCAT slave station information

EtherCAT slave station information file (.xml) is read by the master station to construct the master and slave station configuration. This file contains mandatory information about EtherCAT communication settings. INVT provides this file EC-TX508\_100.xml.

### 6.4.3 EtherCAT state machine

EtherCAT state machine is used to describe the states and state change of slave station applications. Generally, the master station sends a state change request, while the slave station responds. The state change flow is shown in the following figure.

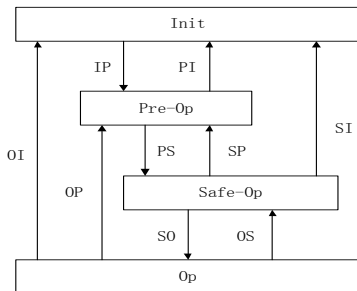

Figure 6-4 EtherCAT state machine flowchart

Table 6-5 EtherCAT state machine description

State	Description
Init	Both SDO and PDO communication are unavailable.
Init to Pre-Op	The master station configures the data link layer address and SM channel for SDO communication. The master station initializes DC synchronization information. The master station requests the jump to the Pre-Op state. The master station configures the application layer control register. The slave station checks whether the mailbox is initialized properly.
Pre-Op	SDO communication is available but PDO is unavailable.
Pre-Op to Safe-Op	The master station configures the SM and FMMU channels for PDO communication. The main station configures PDO mapping through SDO communication. The master station requests the jump to the Safe-Op state. The slave station checks whether the PDO and DC are configured correctly.

State	Description
Safe-Op	SDO communication is available. Communication of receiving PDOs is available, but that of sending PDOs is unavailable, in the Safe state.
Safe-Op to Op	The master station requests the jump to the Op state.
Op	Both SDO and PDO communication are available.

#### 6.4.4 PDO mapping

The process data of an EtherCAT slave station is composed of SM channel objects. Each SM channel object describes the consistent area of the EtherCAT process data and includes multiple PDOs. An EtherCAT slave station with the application control function shall support PDO mapping and reading of SM PDO assigned objects.

The master station can select objects from the object dictionary to perform PDO mapping. PDO mapping configuration is located in the range of 1600h~1603h (RxPDOs: receiving PDOs) and range of 1A00h~1A03h (TxPDOs: sending PDOs) in the object dictionary. The PDO mapping method is shown in the following figure.

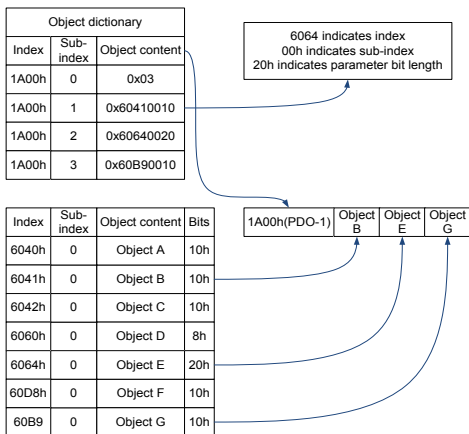

Figure 6-5 PDO mapping method

In addition to PDO mapping, EtherCAT process data switching needs to assign PDOs to SM channels. The relationship between PDOs and SM channels is established through SM PDO assigned objects (1C12h and 1C13h). The mapping between SM channels and PDOs is shown in the following figure.

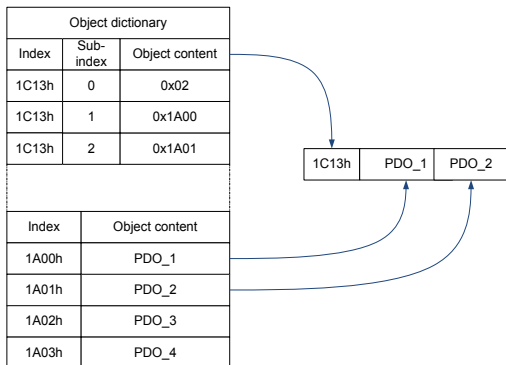

Figure 6-6 SM PDO assignment

Default PDO mapping (Position, Velocity, Torque, Torque limit, Touch probe):

RxPDO (0x1600)	Control word (0x6040)	Target Position (0x607A)	Target Velocity (0x60FF)	Target Torque (0x6071)	Max. Torque (0x6072)	Mode of Operation (0x6060)	Profile velocity (0x6081)	Touch Probe Function (0x60B8)
TxPDO (0x1A00)	Status word (0x6041)	Position Actual Value (0x6064)	Speed Actual Value (0x606C)	Torque Actual Value (0x6077)	Following Error Actual Value (0x60F4)	Mode of Operation Display (0x6061)	Error Code (0x603F)	Touch Probe Value (0x60BA)

#### 6.4.5 DC-based network synchronization

The DC (distributed clock) can enable all EtherCAT devices to use the same system time so as to control the synchronous execution of all device tasks. In the EtherCAT network, the clock with the DC function of the first slave station connected to the master station is used as the reference clock across the network. The other slave stations and master station use this reference clock for synchronization.

Free-Run: The running cycle and communication cycle of each servo drive are not related to the communication cycle of the master station.

DC Mode: The servo drive performs synchronization through Sync0 of the master station.

### 6.5 CiA402 device protocol

The master station controls the drive through the control word (0x6040) and obtains the

current state of the drive by reading the status word (0x6041). The servo drive implements motor control based on master station control commands.

### 6.5.1 CoE state machine

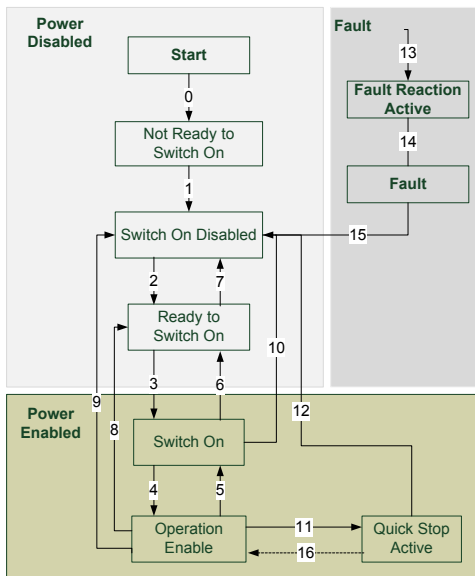

Figure 6-7 CANopen over EtherCAT state machine

Status	Description
Not Ready to Switch On	The drive is in the initialization process.
Switch On Disabled	Drive initialization completes.
Ready to Switch On	The drive is preparing to enter the Switch On state, but the motor is not excited.
Switched On	The drive is in the ready state, and the main circuit power supply is normal.
Operation Enable	The drive is enabled and controls the motor based on the control mode.
Quick Stop Active	The drive stops in the set manner.
Fault Reaction Active	When detecting an alarm, the drive stops in the set

Status	Description
	manner, but the motor still has the exciting signal.
Fault	The drive is in the faulty state, and the motor has no exciting signal.

6040h control word includes:

1. Bit for status control;
2. Bit related to control mode;
3. Factory-defined control bit.

The bits of 6040h are described as follows.

15	11	10	9	8	7	6	4	3	2	1	0
Factor y define	Reserve d		Suspend		Fault reset	Operatio n mode		Servo runnin g	Quic k stop	Switc h on main circuit	Serv o bein g runn ing
O	O		O		M	O		M	M	M	M
MSB						LSB					

BITS 0–3 AND 7 (used for status control):

Command	Bit of the control word					Transiti ons
	Fault reset	Enable operation	Quick stop	Enable voltage	Switch on	
Shutdown	0	X	1	1	0	2,6,8
Switch on	0	0	1	1	1	3*
Switch on	0	1	1	1	1	3**
Disable voltage	0	X	X	0	X	7,9,10, 12
Quick stop	0	X	0	1	X	7,10,11
Disable operation	0	0	1	1	1	5
Enable operation	0	1	1	1	1	4,16
Fault reset	0-1	X	X	X	X	15

## BITS 4, 5, 6 AND 8 (related to control mode)

Bit	Operation mode		
	Profile position mode	Profile velocity mode	Homing mode
4	New set-point	Reserved	Homing operation start
5	Change set immediately	Reserved	Reserved
6	Abs/rel	Reserved	Reserved
8	Halt	Halt	Halt

Control word is set to 0x0F for enabling the drive. Otherwise, the drive will stop. When a fault occurs, if bit 7 of the control word is set to 1, the reset command is enabled.

6041h status word includes:

1. Current status bit of drive;
2. Status bit related to control mode;
3. Factory-defined status bit.

The bits of 6041h are described as follows:

Bit	Description	M/O
0	Ready to switch on	M
1	Switched on	M
2	Operation enabled	M
3	fault	M
4	Voltage enable	M
5	Quick stop	M
6	Switch on disabled	M
7	Warning	O
8	Manufacture specific	O
9	Remote	M
10	Target reached	M
11	Internal limit active	M

Bit	Description	M/O
12-13	Operation mode specific	O
14-15	Manufacturer specific	O

BIT0–3, 5, AND 6 (related to control mode)

Value(binary)	State
xxxx xxxx x0xx 0000	Not ready to switch on
xxxx xxxx x1xx 0000	Switch on disabled
xxxx xxxx x01x 0001	Ready to switch on
xxxx xxxx x01x 0011	Switched on
xxxx xxxx x01x 0111	Operation enabled
xxxx xxxx x00x 0111	Quick stop active
xxxx xxxx x0xx 1111	Fault reaction active
xxxx xxxx x0xx 1000	Fault

BIT4: Voltage enable, when this bit is 1, it indicates that the main circuit power supply is normal.

BIT9: Remote, when this bit is 1, it indicates that the slave station is in the OP state, and the master station can control the drive through PDO.

BIT10: Target reached, this bit differs in meaning under different control modes. When this bit is 1, in cyclic synchronous position mode, it indicates that target position is reached, while in cyclic synchronous velocity mode, it indicates that reference speed is reached; in homing mode, it indicates that homing is completed.

BIT14: When this bit is 1, it indicates motor zero-speed state.

BIT7–8, BIT11–13, and BIT15: Reserved.

### 6.5.2 Device running mode

Set P00.01=2 (command running channel), P00.02=3 (EtherCAT communication channel), and P16.18 Communication timeout. Position mode and homing mode are achieved only when the drive is in the closed-loop mode.

#### 6.5.2.1 Cyclic Synchronous Position Mode

1. Set **【6060h: Mode of operations】** to 8 (Cyclic synchronous position mode).
2. Set **【6040h: Control word】** to enable the drive (set it to 0x0F for enabling).
3. Set **【607Ah: Target position】** to the target position (unit: user unit).
4. Query for **【6064h: Position actual value】** to obtain actual position feedback of the motor.
5. Query for **【6041h: Status word】** to obtain the status feedback of the drive (following error,

target reached and internal limit active).

6. For function details, see function parameters in group P21 in GD350 and the specific function commissioning instructions in the basic operations in the manual.

#### 6.5.2.2 Profile Position Mode

1. Set **【6060h: Mode of operations】** to 1 (Profile Position Mode).
2. Set tens of P21.00 (Position command source) to 1 (Digital position), and set P21.16 (Digital positioning mode).
3. Set **【6040h: Control word】** to enable the drive (set it to 0x0F for enabling).
4. Set **【607Ah: Target position】** to the target position (unit: user unit).
5. Query for **【6064h: Position actual value】** to obtain actual position feedback of the motor.
6. Query for **【6041h: Status word】** to obtain the status feedback of the drive (following error, target reached and internal limit active).
7. For function details, see function parameters in group P21 in GD350 and the specific function commissioning instructions in the basic operations in the manual.

#### 6.5.2.3 Homing Mode

1. Set **【6060h: Mode of operations】** to 6 (homing mode).
2. Set P22.00.Bit0=1 to enable the spindle positioning, and set P22.03–P22.06.
3. Set **【6040h: Control word】** to enable the drive (set it to 0x0F for enabling). Homing operation start (Bit4) changes from 0 to 1 (Control word Bit4 is set to 1). However, the change from 1 to 0 will terminate Homing.
4. The motor queries the limit switch and Home switch to complete Homing.
5. Query **【6041h: Status word】** to obtain the status feedback of the drive (Homing error, Homing attained, and Target reached).
6. For function details, see function parameters in group P22 in GD350 and the specific function commissioning instructions in the basic operations in the manual.

#### 6.5.2.4 Cyclic Synchronous Velocity Mode

1. Set **【6060h: Mode of operations】** to 9 (Cyclic synchronous velocity mode).
2. Set **【6040h: Control word】** to enable the drive (set it to 0x0F for enabling) and start the motor for running.
3. Set **【60FFh: Target velocity】** to set the target rotation speed (unit: rpm), which corresponds to P00.10 (a positive value indicates forward rotation and a negative value indicates reverse rotation).
4. Query **【6041h: Status word】** to obtain the status feedback of the drive (Speed zero, Max slippage error, Target reached, and Internal limit active).



### 6.5.2.5 Cyclic Synchronous torque Mode

1. Set **【6060h: Mode of operations】** to 10 (Cyclic synchronous torque mode).
2. Set the VFD to torque control (P03.32=1).
3. Set **【6040h: Control word】** to enable the drive (set it to 0x0F for enabling) and start the motor for running.
4. Set **【6071h: Target torque】** to set the target torque.
5. Query **【6041h: Status word】** to obtain the status feedback of the drive (Speed zero, Max slippage error, Target reached, and Internal limit active).

## 6.6 Function code modification

Index	Sub-index	Description	Permission	Data type	Default
2000h	0	Read function codes	RW	UINT32	0
Bits 16–31: Read function code addresses Bits 00–15: No function Example of read operation: Read the keypad-set frequency (value of P00.10) SDO operates 2000h to write 0x00A00000. View the response value of 2001h read operation.					
2001h	0	Read response	RO	UINT32	0
Bits 16–31: 0x0001 read success Bits 00–15: Parameter value read by 2000h Bits 16–31: 0x0003 read error Bits 00–15: Error codes 0x0002 illegal data address 0x0009 password protection					
2002h	0	Write function codes	RW	UINT32	0
Bits 16–31: Write function codes Bits 00–15: Written data Write operation example: Modify the value of P00.10 to 50.00. SDO operates 2002h to write 0x000A1388. View the response value of 2003h write operation.					
2003h	0	Write response	RO	UINT32	0

Index	Sub-index	Description	Permission	Data type	Default
Bits 16–31:	0x0001	write success			
Bits 00–15:		Parameter value written by 2002h			
Bits 16–31:	0x0003	write error			
Bits 00–15:		Error codes			
	0x0002	illegal data address			
	0x0003	illegal data value			
	0x0007	read-only parameter			
	0x0008	the parameter is unchangeable during running			

## 6.7 Example for TwinCAT2 application

This example shows how to use TwinCAT2 as the main station for simple communication with the EtherCAT module of the VFD.

1. Install TwinCAT2 software
2. Copy the EtherCAT configuration file (EC-TX508\_100.xml) of GD350 to the installation directory of TwinCAT2 ("C:\TwinCAT\Io\EtherCAT").
3. Open TwinCAT2

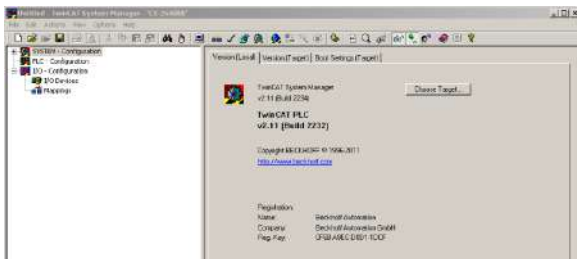

4. Install the network card drive

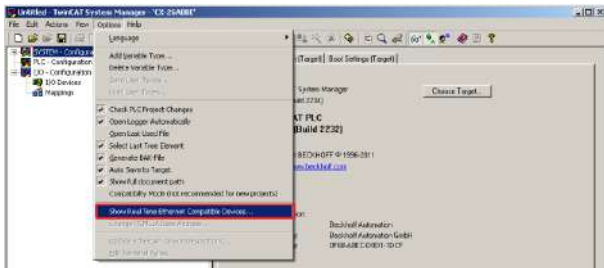

Open the menu as shown in the above figure, select "Show Realtime Ethernet Compatible Devices...", pop up a dialog box as shown in the following figure, select the local area network card, and click "Install". After the network card is installed successfully, it will shown under the menu "Installed and ready to use devices". (Note: Please choose the network cards configured with Intel chips)

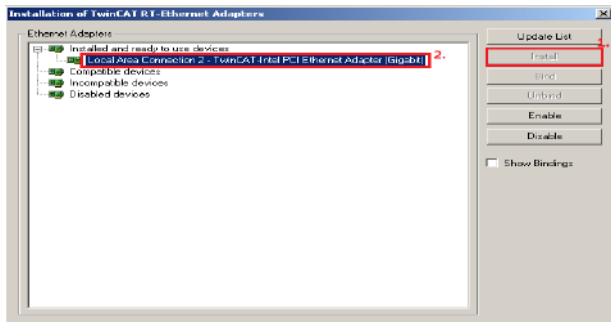

5. Set TwinCAT2 to be in the configuration mode

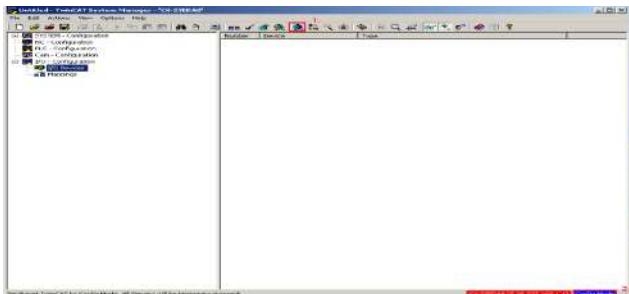

## 6. Scan device

Select "I/O Devices" menu, and right-click to select "Scan Devices..." to scan the device.



Pop up the following dialog box, and select "OK".

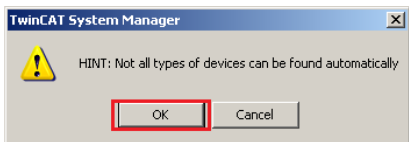

Pop up the following dialog box, and select "OK".

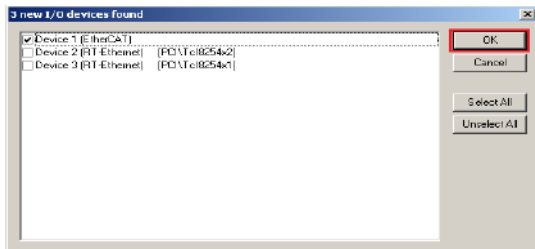

Pop up the following dialog box, and select "Yes".

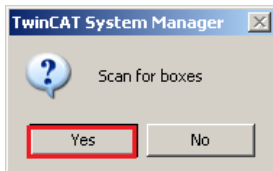

Pop up the following dialog box, and select "Yes". Then the device enters the free running mode.

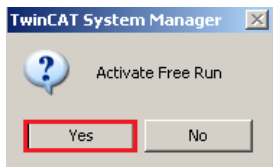

The following figure shows "Box3" which is the slave device scanned, and view that the device enters the "OP" state.

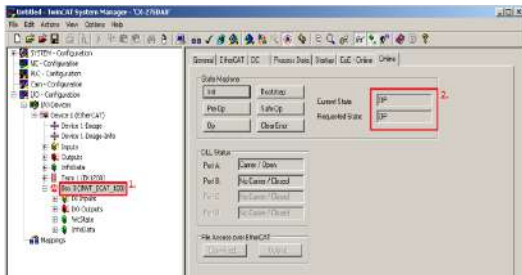

## 7. Process data input and output

Select "DO Outputs" menu, and there are data sent from the master station to the VFD, which can be used to set commands and rotation speed.

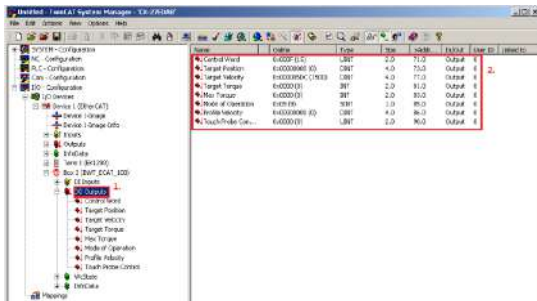

Select "DI Inputs" menu, and there are data sent from the VFD to the master station, which can be used to return the statuses and and rotation speed.

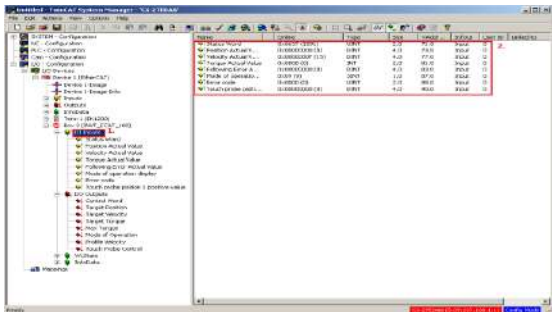

## 8. SDO data operation

Select "CoE-Online" menu, as shown in the figure below. Read the VFD function code parameters through index 0x2000, and double click 0x2000 to pop up a dialog box. Write the parameter address in the dialog box, and click "OK". The returned results are stored in index 0x2001. Similarly, Write the VFD function code parameters through index 0x2002, and the written results are stored in index 0x2003.

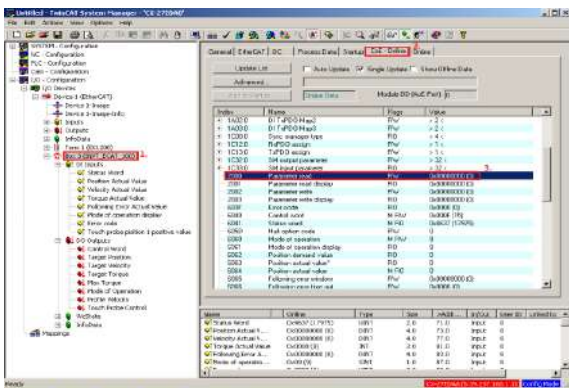

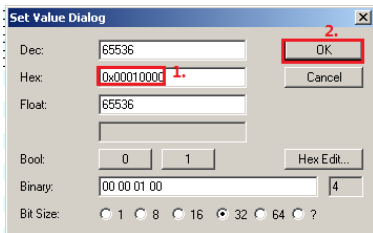



## Appendix A CANopen object dictionary

Index (hexadecimal)	Subindex	Description	Access permission	Data type	Default value
1000	0	Device type	RO	Unsigned32	0x0000 0000
1001	0	Error register	RO	Unsigned8	/
1003	<b>Error code register</b>				
	0	Number of subindexes	RW	/	/
	1	Error code	RO	Unsigned32	/
1005	0	COB-ID SYNC	RW	Unsigned32	/
1006	0	Communication cycle period	RW	Unsigned32	/
1007	0	Length of synchronous window	RW	Unsigned32	/
1008	0	Manufacturer-defined device name	CONST	String	INVT CANopen
1009	0	Manufacturer-defined hardware version	CONST	String	V1.00
100A	0	Manufacturer-defined software version	CONST	String	V1.00
100C	0	Protection time	RW	Unsigned16	0
100D	0	Life cycle factor	RW	Unsigned16	0
1016	<b>Consumer heartbeat time</b>				
	0	Number of subindexes	RO	Unsigned8	/
	1	Consumer heartbeat time	RW	Unsigned32	/
1017	0	Producer heartbeat time	RW	Unsigned16	0
1018	<b>Identifier objects</b>				
	0	Number of subindexes	RO	Unsigned8	4
	1	Supplier ID	RO	Unsigned32	0x0000 0000
	2	Product code	RO	Unsigned32	0x0000 0000
	3	Revision No.	RO	Unsigned32	0x0000 0000

Index (hexadecimal)	Subindex	Description	Access permission	Data type	Default value
	4	Sequence No.	RO	Unsigned32	0x0000 0000
1200	<b>Servo SDO</b>				
	0	Number of subindexes	RO	Unsigned8	/
	1	COB-ID Client -> server (Rx)	RO	Unsigned32	600H+Node ID
	2	COB-ID Server -> client (Tx)	RO	Unsigned32	580H+Node ID
1280	<b>SDO</b>				
	0	Number of subindexes	RO	Unsigned8	/
	1	COB-ID Client -> server (Rx)	RO	Unsigned32	/
	2	COB-ID Server -> client (Tx)	RO	Unsigned32	/
	3	Node ID of server SDO	RO	Unsigned8	/
1400	<b>PDO1 Rx communication parameters</b>				
	0	Supported Max. number of subindexes	RO	Unsigned8	/
	1	COB-ID used by PDO	RW	Unsigned32	/
	2	Transmission type	RW	Unsigned8	/
	3	/	/	Unsigned16	/
	4	/	/	Unsigned8	/
	5	Event timer	RW	Unsigned16	/
1401	<b>PDO2 Rx communication parameters</b>				
	0	Supported Max. number of subindexes	RO	Unsigned8	/
	1	COB-ID used by PDO	RW	Unsigned32	/
	2	Transmission type	RW	Unsigned8	/
	3	/	/	Unsigned16	/
	4	/	/	Unsigned8	/
	5	Event timer	RW	Unsigned16	/
1402	<b>PDO3 Rx communication parameters</b>				

Index (hexadecimal)	Subindex	Description	Access permission	Data type	Default value
	0	Supported Max. number of subindexes	RO	Unsigned8	/
	1	COB-ID used by PDO	RW	Unsigned32	/
	2	Transmission type	RW	Unsigned8	/
	3	/	/	Unsigned16	/
	4	/	/	Unsigned8	/
	5	Event timer	RW	Unsigned16	/
1403	<b>PDO4 Rx communication parameters</b>				
	0	Supported Max. number of subindexes	RO	Unsigned8	/
	1	COB-ID used by PDO	RW	Unsigned32	/
	2	Transmission type	RW	Unsigned8	/
	3	/	/	Unsigned16	/
	4	/	/	Unsigned8	/
	5	Event timer	RW	Unsigned16	/
1600	<b>PDO1 Rx mapping parameters</b>				
	0	Number of application program objects mapped in PDO	RW	Unsigned8	3
	1	First mapped object	RW	Unsigned32	0x21000010
	2	Second mapped object	RW	Unsigned32	0x21000110
	3	Third mapped object	RW	Unsigned32	0x21000210
1601	<b>PDO2 Rx mapping parameters</b>				
	0	Number of application program objects mapped in PDO	RW	Unsigned8	4
	1	First mapped object	RW	Unsigned32	0x21010010
	2	Second mapped	RW	Unsigned32	0x21000310

Index (hexadecimal)	Subindex	Description	Access permission	Data type	Default value
		object			
	3	Third mapped object	RW	Unsigned32	0x21000410
	4	Fourth mapped object	RW	Unsigned32	0x21000510
1602	<b>PDO3 Rx mapping parameters</b>				
	0	Number of application program objects mapped in PDO	RW	Unsigned8	4
	1	First mapped object	RW	Unsigned32	0x21000610
	2	Second mapped object	RW	Unsigned32	0x21000710
	3	Third mapped object	RW	Unsigned32	0x21000810
	4	Fourth mapped object	RW	Unsigned32	0x21000910
1603	<b>PDO4 Rx mapping parameters</b>				
	0	Number of application program objects mapped in PDO	RW	Unsigned8	4
	1	First mapped object	RW	Unsigned32	0x21000a10
	2	Second mapped object	RW	Unsigned32	0x21000b10
	3	Third mapped object	RW	Unsigned32	0x21000c10
1800	<b>PDO1 Tx communication parameters</b>				
	0	Supported Max. number of subindexes	RO	Unsigned8	/
	1	COB-ID used by PDO	RW	Unsigned32	/
	2	Transmission type	RW	Unsigned8	255

Index (hexadecimal)	Subindex	Description	Access permission	Data type	Default value
	3	Disabled time	RW	Unsigned16	500
	4	Reserved	RW	Unsigned8	/
	5	Event timer	RW	Unsigned16	0
1801	<b>PDO2 Tx communication parameters</b>				
	0	Supported Max. number of subindexes	RO	Unsigned8	/
	1	COB-ID used by PDO	RW	Unsigned32	/
	2	Transmission type	RW	Unsigned8	254
	3	Disabled time	RW	Unsigned16	500
	4	Reserved	RW	Unsigned8	/
	5	Event timer	RW	Unsigned16	0
1802	<b>PDO3 Tx communication parameters</b>				
	0	Supported Max. number of subindexes	RO	Unsigned8	/
	1	COB-ID used by PDO	RW	Unsigned32	/
	2	Transmission type	RW	Unsigned8	254
	3	Disabled time	RW	Unsigned16	500
	4	Reserved	RW	Unsigned8	/
1803	<b>PDO4 Tx communication parameters</b>				
	0	Supported Max. number of subindexes	RO	Unsigned8	/
	1	COB-ID used by PDO	RW	Unsigned32	/
	2	Transmission type	RW	Unsigned8	254
	3	Disabled time	RW	Unsigned16	500
	4	Reserved	RW	Unsigned8	/
1A00	<b>PDO1 Tx mapping parameters</b>				
	0	Number of application program objects mapped in PDO	RW	Unsigned8	3

Index (hexadecimal)	Subindex	Description	Access permission	Data type	Default value
	1	First mapped object	RW	Unsigned32	0x20000010
	2	Second mapped object	RW	Unsigned32	0x20000110
	3	Third mapped object	RW	Unsigned32	0x20000210
1A01	<b>PDO2 Tx mapping parameters</b>				
	0	Number of application program objects mapped in PDO	RW	Unsigned8	4
	1	First mapped object	RW	Unsigned32	0x20010010
	2	Second mapped object	RW	Unsigned32	0x20000310
	3	Third mapped object	RW	Unsigned32	0x20000410
	4	Fourth mapped object	RW	Unsigned32	0x20000510
1A02	<b>PDO3 Tx mapping parameters</b>				
	0	Number of application program objects mapped in PDO	RW	Unsigned8	4
	1	First mapped object	RW	Unsigned32	0x20000610
	2	Second mapped object	RW	Unsigned32	0x20000710
	3	Third mapped object	RW	Unsigned32	0x20000810
	4	Fourth mapped object	RW	Unsigned32	0x20000910
1A03	<b>PDO4 Tx mapping parameters</b>				
	0	Number of application program objects mapped in PDO	RW	Unsigned8	4
	1	First mapped	RW	Unsigned32	0x20000a10

Index (hexadecimal)	Subindex	Description	Access permission	Data type	Default value
		object			
	2	Second mapped object	RW	Unsigned32	0x20000b10
	3	Third mapped object	RW	Unsigned32	0x20000c10
	4	Fourth mapped object	RW	Unsigned32	0x20000d10

## Appendix B EtherCAT object dictionary

Index	Subindex	Description	Access permission	Data type	Default value
1000h	0	Device type	RO	UINT32	0x00000192
1001h	0	Error register	RO	UINT8	0
1008h	0	Factory device name	RO	String	INVT-EtherCAT
1009h	0	Factory hardware version	RO	String	Hardware version depended
100Ah	0	Factory software version	RO	String	Software version depended
1018h	<b>ID object</b>				
	0	Included max. sub-index	RO	UINT8	4
	1	Supplier ID	RO	UINT32	0x000004D8
	2	Product code	RO	UINT32	0x00009252
	3	Revision number	RO	UINT32	0x00000001
	4	Serial number	RO	UINT32	0x00000001
1600h	<b>RX PDO1 mapping parameter</b>				
	0	Number of supported mapping objects	RW	UINT8	8
	1	First mapping object	RW	UINT32	0x60400010
	2	Second mapping object	RW	UINT32	0x607A0020
	3	Third mapping object	RW	UINT32	0x60FF0020
	4	Fourth mapping object	RW	UINT32	0x60710010
	5	Fifth mapping object	RW	UINT32	0x60720010
	6	Sixth mapping object	RW	UINT32	0x60600008
	7	Seventh	RW	UINT32	0x60810020



Index	Subindex	Description	Access permission	Data type	Default value
		mapping			
	8	Eighth mapping object	RW	UINT32	0x60B80010
1601h	<b>RX PDO2 mapping parameter</b>				
	0	Number of supported mapping objects	RW	UINT8	2
	1	First mapping object	RW	UINT32	0x60400010
	2	Second mapping object	RW	UINT32	0x607A0020
1602h	<b>RX PDO3 mapping parameter</b>				
	0	Number of supported mapping objects	RW	UINT8	2
	1	First mapping object	RW	UINT32	0x60400010
	2	Second mapping object	RW	UINT32	0x607A0020
1603h	<b>RX PDO4 mapping parameter</b>				
	0	Number of supported mapping objects	RW	UINT8	2
	1	First mapping object	RW	UINT32	0x60400010
	2	Second mapping object	RW	UINT32	0x607A0020
1A00h	<b>TX PDO1 mapping parameter</b>				
	0	Number of supported mapping objects	RW	UINT8	8
	1	First mapping object	RW	UINT32	0x60410010
	2	Second mapping object	RW	UINT32	0x60640020

Index	Subindex	Description	Access permission	Data type	Default value
	3	Third mapping object	RW	UINT32	0x606C0020
	4	Fourth mapping object	RW	UINT32	0x60770010
	5	Fifth mapping object	RW	UINT32	0x60F40020
	6	Sixth mapping object	RW	UINT32	0x60610008
	7	Seventh mapping object	RW	UINT32	0x60B90010
	8	Eighth mapping object	RW	UINT32	0x60BA0020
1A01h	<b>TX PDO2 mapping parameter</b>				
	0	Number of supported mapping objects	RW	UINT8	8
	1	First mapping object	RW	UINT32	0x60410010
	2	Second mapping object	RW	UINT32	0x60640020
1A02h	<b>TX PDO3 mapping parameter</b>				
	0	Number of supported mapping objects	RW	UINT8	8
	1	First mapping object	RW	UINT32	0x60410010
	2	Second mapping object	RW	UINT32	0x60640020
1A03h	<b>TX PDO4 mapping parameter</b>				
	0	Number of supported mapping objects	RW	UINT8	8
	1	First mapping object	RW	UINT32	0x60410010
	2	Second mapping object	RW	UINT32	0x60640020

Index	Subindex	Description	Access permission	Data type	Default value
1C00h	<b>SM communication type</b>				
	0	Max. sub-index	RO	UINT8	4
	1	SM0 communication type	RO	UINT8	0x01
	2	SM1 communication type	RO	UINT8	0x02
	3	SM2 communication type	RO	UINT8	0x03
	4	SM3 communication type	RO	UINT8	0x04
1C12h	<b>RxPDO assignment</b>				
	0	Max. sub-index	RW	UINT8	1
	1	RxPDO assigned object index	RW	UINT16	0x1600
1C13h	<b>TxPDO assignment</b>				
	0	Max. sub-index	RW	UINT8	1
	1	TxPDO assigned object index	RW	UINT16	0x1A00
1C32h	<b>SM synchronization output parameter</b>				
	0x00	Max. sub-index	RO	UINT8	0x20
	0x01	Synchronization mode	RW	UINT16	0x02
	0x02	Cycle time	RO	UINT32	0
	0x03	Switching time	RO	UINT32	0
	0x04	Supported synchronization type	RO	UINT16	0x4006
	0x05	Min. periodic time	RO	UINT32	0x0003D090
	0x06	Calculation and replication time	RO	UINT32	0
0x07	Reserved	RW	UINT32	0	

Index	Subindex	Description	Access permission	Data type	Default value
	0x08	Obtained periodic time	RW	UINT16	0
	0x09	Delay time	RO	UINT32	0
	0x0A	Sync0 time	RW	UINT32	-
	0x0B	SM event loss counter	RO	UINT32	0
	0x0C	Circulation timeout counter	RO	UINT32	0
	0x0D	Counter of too short switching	RO	UINT32	0
	0x20	Synchronization error	RO	UINT8	0
	<b>SM synchronization input parameter</b>				
	0x00	Max. sub-index	RO	UINT8	0x20
	0x01	Synchronization mode	RW	UINT16	0x02
	0x02	Cycle time	RO	UINT32	0
	0x03	Switching time	RO	UINT32	0
	0x04	Supported synchronization type	RO	UINT16	0x4006
	0x05	Min. periodic time	RO	UINT32	0x0003D090
	0x06	Calculation and replication time	RO	UINT32	0
1C33h	0x07	Reserved	RW	UINT32	0
	0x08	Obtained periodic time	RW	UINT16	0
	0x09	Delay time	RO	UINT32	0
	0x0A	Sync0 time	RW	UINT32	-
	0x0B	SM event loss counter	RO	UINT32	0
	0x0C	Circulation timeout counter	RO	UINT32	0
	0x0D	Counter of too short switching	RO	UINT32	0
	0x20	Synchronization error	RO	UINT8	0

Index	Subindex	Description	Access permission	Data type	Default value
2000h	0	Read function codes	RW	UINT32	0
2001h	0	Read response	RO	UINT32	0
2002h	0	Write function codes	RW	UINT32	0
2003h	0	Write response	RO	UINT32	0
603Fh	0	Error code	RO	UINT16	0
6040h	0	Control word	RW	UINT16	0
6041h	0	Status word	RO	UINT16	0
605Dh	0	Suspension mode	RW	INT16	0
6060h	0	Operation mode	RW	UINT16	0
6061h	0	Operation mode display	RO	UINT16	0
6062h	0	Position command	RO	DINT32	0
6063h	0	Position feedback	RO	DINT32	0
6064h	0	Position feedback	RO	DINT32	0
6065h	0	Position deviation range	RW	UDINT32	0
6066h	0	Too-large position deviation timeout	RW	UINT16	0
6067h	0	Position pulse range	RW	UDINT32	0
606Ch	0	Actual speed	RW	DINT32	0
6071h	0	Target torque	RW	INT16	0
6072h	0	Max. torque	RW	UINT16	0
6073h	0	Max. current	RO	UINT16	0
6075h	0	Motor rated current	RO	UDINT32	0
6076h	0	Motor rated torque	RO	UDINT32	0
6077h	0	Actual torque	RO	INT16	0
6078h	0	Actual current	RO	INT16	0

Index	Subindex	Description	Access permission	Data type	Default value
6079h	0	Bus voltage	RO	UDINT32	0
607Ah	0	Target position	RW	INT16	0
607Bh	<b>Position range limit</b>				
	0	Number of sub-indexes	RW	UINT8	2
	1	Min. position range limit	RW	INT32	0
	2	Max. position range limit	RW	INT32	0
607Ch	0	Coordinate deviation	RW	DINT32	0
6081h	0	Speed in industrial regulations	RW	UDINT32	0
6083h	0	ACC in industrial regulations	RW	UDINT32	0
6084h	0	DEC in industrial regulations	RW	UDINT32	0
6091h	<b>Gear ratio</b>				
	0	Number of sub-indexes	RW	UINT8	2
	1	Motor resolution	RW	UINT32	0x00000001
	2	Bearing axle resolution	RW	UINT32	0x00000001
6093h	<b>Position factor</b>				
	0	Number of sub-indexes	RW	UINT8	2
	1	Molecule	RW	UINT32	0x00000001
	2	Set constant	RW	UINT32	0x00000001
6098h	0	Zeroing mode	RW	INT16	0
6099h	<b>Zeroing speed</b>				
	0	Number of sub-indexes	RW	UINT8	2
	1	Search limit switch speed	RW	UINT32	0
	2	Search	RW	UINT32	0

Index	Subindex	Description	Access permission	Data type	Default value
		zero-phase speed			
60B8h	0	Probe control	RW	UINT16	0
60B9h	0	Probe status	RO	UINT16	0
60BAh	0	Probe position rising edge	RO	INT32	0
60F4h	0	Position deviation	RO	INT32	0
60FDh	0	Digital input	RO	UINT32	0
60FEh	0	Digital output	RO	INT32	0
60FFh	0	Target speed	RW	INT32	0
6502h	0	Drive mode	RO	UINT32	0x000003A5

## Appendix C Related function codes

Function code	Name	Parameter description	Setting range	Default value
P00.01	Channel of running commands	0: Keypad 1: Terminal 2: Communication	0–2	0
P00.02	Communication channel of running commands	0: Modbus communication 1: PROFIBUS/CANopen/DeviceNet communication 2: Ethernet communication 3: EtherCAT/PROFINET/EtherNet/IP communication 4: PLC programmable extension card 5: Wireless communication card <b>Note:</b> Channels 1, 2, 3, 4, and 5 are extension functions that require corresponding extension cards.	0–5	0
P00.06	Frequency A command setting mode	0: Keypad 1–8: Reserved 9: PROFIBUS/CANopen/DeviceNet communication	0–15	0
P00.07	Frequency B command setting mode	10: Ethernet communication 11–12: Reserved 13: EtherCAT/PROFINET/EtherNet/IP communication 14–15: Reserved	0–15	2
P03.11	Torque setting mode	0–1: Keypad 2–7: Reserved 8: PROFIBUS/CANopen/DeviceNet communication 9: Ethernet communication 10: Reserved 11: EtherCAT/PROFINET/EtherNet/IP communication 12: Reserved	0–12	0
P03.14	Setting mode of upper frequency limit of forward running in torque control	0: Keypad (P03.16) 1–6: Reserved 7: PROFIBUS/CANopen/DeviceNet communication 8: Ethernet communication	0–12	0



Function code	Name	Parameter description	Setting range	Default value
		9: Reserved 10: EtherCAT/PROFINET/EtherNet/IP communication 11–12: Reserved		
P03.15	Setting mode of upper frequency limit of reverse running in torque control	0: Keypad (P03.17) 1–6: Reserved 7: PROFIBUS/CANopen/DeviceNet communication 8: Ethernet communication 9: Reserved 10: EtherCAT/PROFINET/EtherNet/IP communication 11–12: Reserved	0–12	0
P03.18	Setting mode of upper limit of electromotive torque	0: Keypad (P03.20) 1–5: Reserved 6: PROFIBUS/CANopen/DeviceNet communication 7: Ethernet communication 8: Reserved 9: EtherCAT/PROFINET/EtherNet/IP communication 10–11: Reserved	0–11	0
P03.19	Setting mode of upper limit of brake torque	0: Keypad (P03.21) 1–5: Reserved 6: PROFIBUS/CANopen/DeviceNet communication 7: Ethernet communication 8: Reserved 9: EtherCAT/PROFINET/EtherNet/IP communication 10–11: Reserved	0–11	0
P04.27	Voltage setting channel	0: Keypad (P04.28) 1–7: Reserved 8: PROFIBUS/CANopen/DeviceNet communication 9: Ethernet communication 10: Reserved 11: EtherCAT/PROFINET/EtherNet/IP communication 12–13: Reserved	0–13	0

Function code	Name	Parameter description	Setting range	Default value
P06.01	Y1 output	0: Invalid	0–63	0
P06.02	HDO output	1–23: Reserved	0–63	0
P06.03	Relay output RO1	24: PROFIBUS/CANopen/DeviceNet communication virtual terminal output	0–63	1
P06.04	Relay output RO2	25: Ethernet communication virtual terminal output 26–33: Reserved 34: EtherCAT/PROFINET/EtherNet/IP communication virtual terminal output 35–63: Reserved	0–63	5
P06.14	Analog output AO1	0: Running frequency 1–15: Reserved	0–47	0
P06.16	HDO high-speed pulse output	16: PROFIBUS/CANopen/DeviceNet communication setting 1 17: PROFIBUS/CANopen/DeviceNet communication setting 2 18: Ethernet communication setting 1 19: Ethernet communication setting 2 20: Reserved 21: EtherCAT/PROFINET/EtherNet/IP communication setting 1 22–26: Reserved 27: EtherCAT/PROFINET/EtherNet/IP communication setting 2 28–47: Reserved	0–47	0
P07.27	Type of current fault	0: No fault 29: PROFIBUS communication fault (E-DP) 30: Ethernet communication fault (E-NET) 31: CANopen communication fault (E-CAN) 57: PROFINET communication timeout fault (E-PN) 58: CAN communication timeout fault (ESCAN) 60: Card identification failure in slot 1 (F1-Er)	/	/

Function code	Name	Parameter description	Setting range	Default value
		61: Card identification failure in slot 2 (F2-Er) 62: Card identification failure in slot 3 (F3-Er) 63: Card communication failure in slot 1 (C1-Er) 64: Card communication failure in slot 2 (C2-Er) 65: Card communication failure in slot 3 (C3-Er) 66: EtherCAT communication fault (E-CAT) 67: BACnet communication fault (E-BAC) 68: DeviceNet communication fault (E-DEV) 69: CAN slave fault in master/slave synchronous communication (S-Err) 70: EtherNet/IP communication timeout (E-EIP)		
P07.28	Type of last fault	/	/	/
P07.29	Type of 2nd-last fault	/	/	/
P07.30	Type of 3rd-last fault	/	/	/
P07.31	Type of 4th-last fault	/	/	/
P07.32	Type of 5th-last fault	/	/	/
P08.31	Motor 1 and motor 2 switching channel	0x00–0x14 LED ones place: Switching channel 0: Terminal 1: Modbus communication 2: PROFIBUS/CANopen/DeviceNet communication 3: Ethernet communication 4: EtherCAT/PROFINET/EtherNet/IP communication	00–14	0x00

Function code	Name	Parameter description	Setting range	Default value
		LED tens place: Switching in running 0: Disabled 1: Enabled		
P09.00	PID reference source	0: Keypad (P09.01) 1–6: Reserved 7: PROFIBUS/CANopen/DeviceNet communication 8: Ethernet communication 9: Reserved 10: EtherCAT/PROFINET/EtherNet/IP communication 11–12: Reserved	0–12	0
P09.02	PID feedback source	0: AI1 1–4: Reserved 5: PROFIBUS/CANopen/DeviceNet communication 6: Ethernet communication 7: Reserved 8: EtherCAT/PROFINET/EtherNet/IP communication 9–10: Reserved	0–10	0
P15.01	Module address	0–127	0–127	2
P15.02	Received PZD2	0: Invalid	0–31	0
P15.03	Received PZD3	1: Set frequency (0–Fmax, unit: 0.01 Hz)	0–31	0
P15.04	Received PZD4		0–31	0
P15.05	Received PZD5	2: PID reference (0–1000, in which 1000 corresponds to 100.0%)	0–31	0
P15.06	Received PZD6		0–31	0
P15.07	Received PZD7	3: PID feedback (0–1000, in which 1000 corresponds to 100.0%)	0–31	0
P15.08	Received PZD8		0–31	0
P15.09	Received PZD9	4: Torque setting (-3000–+3000, in which 1000 corresponds to 100.0% of the rated current of the motor)	0–31	0
P15.10	Received PZD10		0–31	0
P15.11	Received PZD11		0–31	0
P15.12	Received PZD12	5: Setting of the upper limit of forward running frequency (0–Fmax, unit: 0.01 Hz) 6: Setting of the upper limit of reverse running frequency (0–Fmax, unit: 0.01 Hz)	0–31	0

Function code	Name	Parameter description	Setting range	Default value
		7: Upper limit of the electromotive torque (0–3000, in which 1000 corresponds to 100.0% of the rated current of the motor) 8: Upper limit of the brake torque (0–3000, in which 1000 corresponds to 100.0% of the rated current of the motor) 9: Virtual input terminal command, 0x000–0x3FF (corresponding to S8, S7, S6, S5, HDIB, HDIA, S4, S3, S2, and S1 in sequence) 10: Virtual output terminal command, 0x00–0x0F (corresponding to RO2, RO1, HDO, and Y1 in sequence) 11: Voltage setting (for V/F separation) (0–1000, in which 1000 corresponds to 100.0% of the rated voltage of the motor) 12: AO output setting 1 (-1000–+1000, in which 1000 corresponds to 100.0%) 13: AO output setting 2 (-1000–+1000, in which 1000 corresponds to 100.0%) 14: MSB of position reference (signed number) 15: LSB of position reference (unsigned number) 16: MSB of position feedback (signed number) 17: LSB of position feedback (unsigned number) 18: Position feedback setting flag (position feedback can be set only after this flag is set to 1 and then to 0) 19–31: Reserved		
P15.13	Transmitted PZD2	0: Invalid 1: Running frequency (×100, Hz)	0–31	0

Function code	Name	Parameter description	Setting range	Default value
P15.14	Transmitted PZD3	2: Set frequency ( $\times 100$ , Hz) 3: Bus voltage ( $\times 10$ , V)	0–31	0
P15.15	Transmitted PZD4	4: Output voltage ( $\times 1$ , V) 5: Output current ( $\times 10$ , A)	0–31	0
P15.16	Transmitted PZD5	6: Actual output torque ( $\times 10$ , %) 7: Actual output power ( $\times 10$ , %)	0–31	0
P15.17	Transmitted PZD6	8: Rotating speed of the running ( $\times 1$ , RPM)	0–31	0
P15.18	Transmitted PZD7	9: Linear speed of the running ( $\times 1$ , m/s) 10: Ramp frequency reference	0–31	0
P15.19	Transmitted PZD8	11: Fault code 12: AI1 value ( $\times 100$ , V)	0–31	0
P15.20	Transmitted PZD9	13: AI2 value ( $\times 100$ , V) 14: AI3 value ( $\times 100$ , V)	0–31	0
P15.21	Transmitted PZD10	15: HDIA frequency ( $\times 100$ , kHz) 16: Terminal input state	0–31	0
P15.22	Transmitted PZD11	17: Terminal output state 18: PID reference ( $\times 100$ , %) 19: PID feedback ( $\times 100$ , %)	0–31	0
P15.23	Transmitted PZD12	20: Rated torque of the motor 21: MSB of position reference (signed number) 22: LSB of position reference (unsigned number) 23: MSB of position feedback (signed number) 24: LSB of position feedback (unsigned number) 25: State word 26: HDIB frequency value ( $\times 100$ , kHz) 27–31: Reserved	0–31	0
P15.24	Temporary variable 1 used for transmitted PZD	0–65535	0–65535	0
P15.25	DP communication timeout time	0.0 (invalid)–300.0s	0.0–300.0 0	0.0s
P15.26	CANopen communication timeout time	0.0 (invalid)–300.0s	0.0–300.0 0	0.0s
P15.27	CANopen communication baud rate	0: 1000 kbps 1: 800 kbps 2: 500 kbps	0–7	0

Function code	Name	Parameter description	Setting range	Default value
		3: 250 kbps 4: 125 kbps 5: 100 kbps 6: 50 kbps 7: 20 kbps		
P15.28	CAN communication address	0–127	0–127	1
P15.29	CAN baud rate setting	0: 50 kbps 1: 125 kbps 2: 250 kbps 3: 500 kbps 4: 1 Mbps	0–4	1
P15.30	CAN communication timeout time	0.0 (invalid)–300.0s	0.0–300.0 0	0.0s
P15.31	DeviceNet communication timeout time	0.0 (invalid)–300.0s	0.0–300.0 0	0.0s
P15.32	Displayed node baud rate	0	0	0
P15.33	Enable polling	0–1	0–1	1
P15.34	Output instance in polling	19: INVT VFD output 20: ODVA basic speed control output 21: ODVA extended speed control output 22: ODVA speed and torque control output 23: ODVA extended speed and torque control output 24: INVT basic speed control output 25: INVT extended speed control output 26: INVT speed and torque control output 27: INVT extended speed and torque control output	19–27	19
P15.35	Input instance in polling	69: INVT VFD input 70: ODVA basic speed control input 71: ODVA extended speed control input	69–77	69

Function code	Name	Parameter description	Setting range	Default value
		72: ODVA speed and torque control input 73: ODVA extended speed and torque control input 74: INVT basic speed control input 75: INVT extended speed control input 76: INVT speed and torque control input 77: INVT extended speed and torque control input		
P15.36	Enable state change/period	0–1	0–1	0
P15.37	Output instance in state change/period	19: INVT VFD output 20: ODVA basic speed control output 21: ODVA extended speed control output 22: ODVA speed and torque control output 23: ODVA extended speed and torque control output 24: INVT basic speed control output 25: INVT extended speed control output 26: INVT speed and torque control output 27: INVT extended speed and torque control output	19–27	19
P15.38	Input instance in state change/period	69: INVT VFD input 70: ODVA basic speed control input 71: ODVA extended speed control input 72: ODVA speed and torque control input 73: ODVA extended speed and torque control input 74: INVT basic speed control input 75: INVT extended speed control input 76: INVT speed and torque control input 77: INVT extended speed and torque control input	69–77	69
P15.39	Output length of component 19	8–32	8–32	32



Function code	Name	Parameter description	Setting range	Default value
P15.40	Input length of component 19	8–32	8–32	32
P15.41	BACnet communication mode setting	0: Enable P16.22 (I_Am service) 1: Enable P15.42 (Baud rate of BACnet_MSTP)	0–1	0
P15.42	Baud rate of BACnet_MSTP	0–5	0–5	0
P15.43– P15.69	Reserved			
P16.01	Ethernet communication rate setting	0: Self-adaption 1: 100M full duplex 2: 100M half duplex 3: 10M full duplex 4: 10M half duplex	0–4	0
P16.02	IP address 1	0–255	0–255	192
P16.03	IP address 2	0–255	0–255	168
P16.04	IP address 3	0–255	0–255	0
P16.05	IP address 4	0–255	0–255	1
P16.06	Subnet mask 1	0–255	0–255	255
P16.07	Subnet mask 2	0–255	0–255	255
P16.08	Subnet mask 3	0–255	0–255	255
P16.09	Subnet mask 4	0–255	0–255	0
P16.10	Gateway 1	0–255	0–255	192
P16.11	Gateway 2	0–255	0–255	168
P16.12	Gateway 3	0–255	0–255	1
P16.13	Gateway 4	0–255	0–255	1
P16.14	Ethernet monitoring variable address 1	0x0000–0xFFFF	0000–FF FF	0x0000
P16.15	Ethernet monitoring variable address 2	0x0000–0xFFFF	0000–FF FF	0x0000
P16.16	Ethernet monitoring variable address 3	0x0000–0xFFFF	0000–FF FF	0x0000

Function code	Name	Parameter description	Setting range	Default value
P16.17	Ethernet monitoring variable address 4	0x0000–0xFFFF	0000–FF FF	0x0000
P16.18	EtherCAT communication timeout time	0.0 (invalid)–300.0s	0.0–300. 0s	0.5s
P16.19	Reserved			
P16.20	MSD of BACnet device number	Independent code of BACnet device (0–4194303)	0–4194	0
P16.21	LSD of BACnet device number		0–999	1
P16.22	BACnet "I-Am" service setting	0: Transmission at power-on 1: Continuous transmission	0–1	0
P16.23	BACnet communication timeout time	0.0 (invalid)–300.0s	0.0–300. 0	0.0s
P16.24	Extension card identification time of slot 1	0.0–600.0s When this parameter is set to 0.0, identification fault detection is not performed.	0.0–600. 00	0.0
P16.25	Extension card identification time of slot 2	0.0–600.0s When this parameter is set to 0.0, identification fault detection is not performed.	0.0–600. 00	0.0
P16.26	Extension card identification time of slot 3	0.0–600.0s When this parameter is set to 0.0, identification fault detection is not performed.	0.0–600. 00	0.0
P16.27	Extension card communication timeout time of slot 1	0.0–600.0s When this parameter is set to 0.0, disconnection fault detection is not performed.	0.0–600. 00	0.0
P16.28	Extension card communication timeout time of slot 2	0.0–600.0s When this parameter is set to 0.0, disconnection fault detection is not performed.	0.0–600. 00	0.0

Function code	Name	Parameter description	Setting range	Default value
P16.29	Extension card communication timeout time of slot 3	0.0–600.0s When this parameter is set to 0.0, disconnection fault detection is not performed.	0.0–600.00	0.0
P16.30	Reserved			
P16.31	PROFINET communication timeout time	0.0 (invalid)–300.0s	0.0–300.0	0.0s
P16.32	Received PZD2	0: Invalid	0–31	0
P16.33	Received PZD3	1: Set frequency (0–Fmax, unit: 0.01 Hz)	0–31	0
P16.34	Received PZD4	2: PID reference (0–1000, in which 1000 corresponds to 100.0%)	0–31	0
P16.35	Received PZD5	3: PID feedback (0–1000, in which 1000 corresponds to 100.0%)	0–31	0
P16.36	Received PZD6	4: Torque setting (-3000–+3000, in which 1000 corresponds to 100.0% of the rated current of the motor)	0–31	0
P16.37	Received PZD7	5: Setting of the upper limit of forward running frequency (0–Fmax, unit: 0.01 Hz)	0–31	0
P16.38	Received PZD8	6: Setting of the upper limit of reverse running frequency (0–Fmax, unit: 0.01 Hz)	0–31	0
P16.39	Received PZD9	7: Upper limit of the electromotive torque (0–3000, in which 1000 corresponds to 100.0% of the rated current of the motor)	0–31	0
P16.40	Received PZD10	8: Upper limit of the brake torque (0–3000, in which 1000 corresponds to 100.0% of the rated current of the motor)	0–31	0
P16.41	Received PZD11	9: Virtual input terminal command, 0x000–0x3FF (corresponding to S8, S7, S6, S5, HDIB, HDIA, S4, S3, S2, and S1 in sequence)	0–31	0
P16.42	Received PZD12	10: Virtual output terminal command, 0x00–0x0F (corresponding to RO2, RO1, HDO, and Y1 in sequence)	0–31	0

Function code	Name	Parameter description	Setting range	Default value
		11: Voltage setting (for V/F separation) (0–1000, in which 1000 corresponds to 100.0% of the rated voltage of the motor) 12: AO output setting 1 (-1000–+1000, in which 1000 corresponds to 100.0%) 13: AO output setting 2 (-1000–+1000, in which 1000 corresponds to 100.0%) 14: MSB of position reference (signed number) 15: LSB of position reference (unsigned number) 16: MSB of position feedback (signed number) 17: LSB of position feedback (unsigned number) 18: Position feedback setting flag (position feedback can be set only after this flag is set to 1 and then to 0) 19–31: Reserved		
P16.43	Transmitted PZD2	0: Invalid	0–31	0
P16.44	Transmitted PZD3	1: Running frequency ( $\times 100$ , Hz)	0–31	0
P16.45	Transmitted PZD4	2: Set frequency ( $\times 100$ , Hz) 3: Bus voltage ( $\times 10$ , V)	0–31	0
P16.46	Transmitted PZD5	4: Output voltage ( $\times 1$ , V) 5: Output current ( $\times 10$ , A)	0–31	0
P16.47	Transmitted PZD6	6: Actual output torque ( $\times 10$ , %) 7: Actual output power ( $\times 10$ , %)	0–31	0
P16.48	Transmitted PZD7	8: Rotating speed of the running ( $\times 1$ , RPM)	0–31	0
P16.49	Transmitted PZD8	9: Linear speed of the running ( $\times 1$ , m/s) 10: Ramp frequency reference	0–31	0
P16.50	Transmitted PZD9	11: Fault code 12: AI1 value ( $\times 100$ , V)	0–31	0
P16.51	Transmitted PZD10	13: AI2 value ( $\times 100$ , V) 14: AI3 value ( $\times 100$ , V) 15: HDIA frequency ( $\times 100$ , kHz) 16: Terminal input state	0–31	0

Function code	Name	Parameter description	Setting range	Default value
P16.52	Transmitted PZD11	17: Terminal output state 18: PID reference ( $\times 100$ , %) 19: PID feedback ( $\times 100$ , %) 20: Rated torque of the motor	0–31	0
P16.53	Transmitted PZD12	21: MSB of position reference (signed number) 22: LSB of position reference (unsigned number) 23: MSB of position feedback (signed number) 24: LSB of position feedback (unsigned number) 25: State word 26: HDIB frequency value ( $\times 100$ , kHz) 27–31: Reserved	0–31	0
P16.54	EtherNet/IP communication timeout time	0.5–60.0s	0.5–60.0s	0.0s
P16.55	EtherNet/IP communication rate setting	0: Self-adaption 1: 100M full duplex 2: 100M half duplex 3: 10M full duplex 4: 10M half duplex	0–4	0
P16.56	EtherNetIP control and state word definition method	0: Define by byte 1: Define by bit	0–1	0
P19.00	State of card slot 1	0: No card 1: PLC programmable card	0–65535	0
P19.01	State of card slot 2	2: I/O card 3: Incremental PG card	0–65535	0
P19.02	State of card slot 3	4: Incremental PG card with UVW 5: Ethernet communication card 6: DP communication card 7: Bluetooth card 8: Resolver PG card 9: CANOPEN communication card	0–65535	0

Function code	Name	Parameter description	Setting range	Default value
		10: WIFI card 11: PROFINET communication card 12: Sine-cosine PG card without CD signals 13: Sine-cosine PG card with CD signals 14: Absolute encoder PG card 15: CAN master/slave communication card 16: MODBUS communication card 17: EtherCat communication card 18: BacNet communication card 19: DeviceNet communication card 20: EtherNet/IP communication card		



Service line: 86-755-23535967 E-mail: overseas@invt.com.cn Website: www.invt.com

The products are owned by **Shenzhen INVT Electric Co.,Ltd.**

Two companies are commissioned to manufacture: (For product code, refer to the 2nd/3rd place of S/N on the name plate.)

**Shenzhen INVT Electric Co.,Ltd.** (origin code: 01)

Address: INVT Guangming Technology Building, Songbai Road,  
Matian, Guangming District, Shenzhen, China

**INVT Power Electronics (Suzhou) Co.,Ltd.** (origin code: 06)

Address: No. 1 Kunlun Mountain Road, Science & Technology  
Town, Gaoxin District, Suzhou, Jiangsu, China

- Industrial Automation:  HMI  PLC  VFD  Servo System  
 Elevator Intelligent Control System  Rail Transit Traction System
- Energy & Power:  UPS  DCIM  Solar Inverter  SVG  
 New Energy Vehicle Powerstain System  New Energy Vehicle Charging System  
 New Energy Vehicle Motor



66001-00600