



Operation **Manual**

Goodrive35 Series
Closed-loop Vector Control VFD



Preface

Thanks for choosing our products.

Goodrive35 series variable-frequency drives (VFDs) are high performance closed-loop vector VFDs for controlling asynchronous AC induction motors and permanent magnet synchronous motors. Applying the most advanced non-velocity sensor vector control technology which keeps pace with the leading international technology and DSP control system, our products enhances its reliability to meet the adaptability to the environment, customized and industrialized design with more optimized functions, more flexible application and more stable performance.

The control performance of Goodrive35 series VFDs is as outstanding as that of the leading sophisticated VFDs on worldwide market. Goodrive35 series VFDs integrate the drive of asynchronous motors and synchronous motors, torque control and speed control, meeting the high performance requirement of the customer applications and stepping on the unique incorporated VFDs with superexcellent control functions in this circle. Simultaneously, comparing with the other kinds, Goodrive35 series VFDs can adapt to worse grid, temperature, humidity and dust with a better performance of anti-tripping and improved the reliability.

Goodrive35 series VFDs apply modularized design to meet the specific demand of customers, as well as the demand of the whole industry flexibly and follow the trend of industrial application to the VFDs on the premise of meeting general need of the market. Powerful speed control, torque control, simple PLC, flexible input/output terminals, pulse frequency given, traverse control can realize various complicate high-accuracy drives and provide integrative solution for the manufacturers of industrial devices, which contributes a lot to the cost reducing and improves reliability.

Goodrive35 series VFDs can meet the demand of environmental protection which focuses on low noise and weakening electromagnetic interference in the application sites for the customers.

This manual provides installation and configuration, parameters setting, fault diagnoses and daily maintenance and relative precautions to customers. Please read this manual carefully before the installation to ensure a proper installation and operation and high performance of Goodrive35 series VFDs.

If the end user is a military unit or the product is used for weapon manufacturing, please comply with relevant export control regulations in the Foreign Trade Law of the People's Republic of China, and complete necessary formalities.

Our company reserves the right to update the information of our products.

Contents

Preface	i
Contents	ii
1 Safety precautions	1
1.1 What this chapter contains	1
1.2 Safety definition	1
1.3 Warning symbols	1
1.4 Safety guidelines	2
1.4.1 Delivery and installation	2
1.4.2 Commission and running	3
1.4.3 Maintenance and replacement of components	4
1.4.4 Scrap treatment	4
2 Quick start-up	5
2.1 What this chapter contains	5
2.2 Unpacking inspection	5
2.3 Application confirmation	5
2.4 Environment	5
2.5 Installation confirmation	6
2.6 Basic commission	6
3 Product overview	7
3.1 What this chapter contains	7
3.2 Basic principles	7
3.3 Product specification	8
3.4 Product nameplate	10
3.5 Model code	11
3.6 Rated values	11
3.6.1 Rated value of AC 3PH 380 V (-15%)–440 V (+10%)	11
3.6.2 Rated value of AC 3PH 520 V (-15%)–690 V (+10%)	12
3.7 Structure diagram	14
4 Installation guide	15
4.1 What this chapter contains	15
4.2 Mechanical installation	15
4.2.1 Installation environment	15
4.2.2 Installation direction	16
4.2.3 Installation manner	17
4.2.4 Single installation	18
4.2.5 Multiple installations	18
4.2.6 Vertical installation	19
4.2.7 Tilt installation	20

4.3 Standard wiring	21
4.3.1 Main circuit connection diagram	21
4.3.2 Terminals figure of main circuit	22
4.3.3 Wiring of terminals in main circuit	27
4.4 Standard wiring (control circuit)	28
4.4.1 Wiring diagram of basic control circuit	28
4.4.2 C1 terminal (EC-PG301-24) instruction and the wiring diagram	31
4.4.3 D1 terminal (EC-PG304-05) instruction and the wiring diagram	32
4.4.4 H1 terminal (EC-PG305-12) instruction and the wiring diagram	33
4.4.5 H2 terminal (EC-PG305-05) instruction and the wiring diagram	34
4.4.6 S1 terminal (EC-PG302-05) instruction	36
4.4.7 Input/output signal connection diagram	37
4.5 Wiring protection	38
4.5.1 Protecting the VFD and input power cable in short-circuit situations	38
4.5.2 Protecting the motor and motor cable in short-circuit situations	38
4.5.3 Protecting the motor against thermal overload	38
4.5.4 Implementing a bypass connection	38
5 Keypad operation procedures	39
5.1 What this chapter contains	39
5.2 Keypad	39
5.3 Keypad displaying	41
5.3.1 Displayed state of stopping parameter	41
5.3.2 Displayed state of running parameters	41
5.3.3 Displayed state of fault	42
5.3.4 Displayed state of function codes editing	42
5.4 Keypad operation	42
5.4.1 How to modify the function codes of the VFD	42
5.4.2 How to watch the VFD state through function codes	44
6 Function parameters	45
6.1 What this chapter contains	45
6.2 Goodrive35 general series function parameters	45
P00 Group Basic functions	46
P01 Group Start and stop control	53
P02 Group Motor 1 parameters	59
P03 Group Vector control	63
P04 Group SVPWM control	69
P05 Group Input terminals	73
P06 Group Output terminals	81
P07 Group HMI	85
P08 Group Enhanced functions	91

P09 Group PID control	99
P10 Group Simple PLC and multi-step speed control.....	103
P11 Group Protective parameters.....	106
P12 Group Motor 2 parameters	110
P13 Group SM control.....	115
P14 Group Serial communication	117
P15 Group PROFIBUS/CANopen function.....	119
P16 Group Ethernet function	122
P17 Group Status viewing	122
P18 Group States viewing 2.....	126
P20 Group Encoder.....	128
P21 Group Position control.....	130
P22 Group Spindle positioning.....	137
7 Basic operation instruction.....	141
7.1 What this chapter contains	141
7.2 First powering on.....	141
7.3 Vector control.....	145
7.4 SVPWM control.....	150
7.5 Torque control	154
7.6 Parameters of the motor.....	158
7.7 Start and stop control	162
7.8 Frequency setting.....	166
7.9 Analog input	170
7.10 Analog output	172
7.11 Digital input.....	175
7.12 Digital input	183
7.13 Simple PLC.....	186
7.14 Multi-step speed running	188
7.15 PID control	190
7.15.1 General steps of PID parameters setting:.....	191
7.15.2 PID inching.....	192
7.16 Commissioning for special functions.....	194
7.16.1 Wiring mode of the encoder and pulse reference terminal	194
7.16.2 Commissioning steps.....	196
7.17 Fault solutions.....	202
8 Fault tracking.....	205
8.1 What this chapter contains	205
8.2 Alarm and fault indications.....	205
8.3 How to reset.....	205
8.4 Fault history	205

8.5 Fault instruction and solution	205
8.5.1 VFD faults and solutions	205
8.5.2 Other states	210
8.6 Common fault analysis	210
8.6.1 The motor does not work	210
8.6.2 Motor vibration.....	211
8.6.3 Overvoltage	211
8.6.4 Undervoltage fault.....	212
8.6.5 Abnormal heating of the motor	213
8.6.6 Overheat of the VFD.....	214
8.6.7 Motor stall during ACC.....	214
8.6.8 Overcurrent	215
9 Routine maintenance.....	216
9.1 What this chapter contains	216
9.2 Maintenance intervals.....	216
9.3 Cooling fan.....	218
9.3.1 Replacing the cooling fan.....	218
9.4 Capacitors.....	219
9.4.1 Capacitors reforming	219
9.4.2 Change electrolytic capacitors	220
9.5 Power cable	220
10 Communication protocol.....	221
10.1 What this chapter contains	221
10.2 Brief instruction to Modbus protocol.....	221
10.3 Application of the VFD	221
10.3.1 RS485	221
10.3.2 RTU mode	224
10.4 RTU command code and communication data illustration	227
10.4.1 Command code: 03H, reading N words (continuously reading up to 16 words).....	227
10.4.2 Command code: 06H, writing a word.....	229
10.4.3 Command code: 08H, diagnosis	230
10.4.4 Command code: 10H, continuous writing	230
10.4.5 The definition of data address	231
10.4.6 Fieldbus ratio values.....	235
10.4.7 Fault message response.....	236
10.4.8 Example of writing and reading	238
10.5 Common communication fault	243
Appendix A Expansion card.....	244
A.1 What this chapter contains	244
A.2 PROFIBUS expansion card.....	244

A.2.1 Product naming rules	244
A.2.2 EC-TX103 communication card	245
A.2.3 The appearance of EC-TX103 communication card	246
A.2.4 Compatible motor of EC-TX103 communication card	246
A.2.5 Delivery list	247
A.2.6 Installation of EC-TX103 communication card	247
A.2.7 System configuration	251
A.2.8 PROFIBUS-DP communication	253
A.2.9 Fault information	261
A.3 CANopen optional cards	262
Appendix B Technical data	263
B.1 What this chapter contains	263
B.2 Ratings	263
B.2.1 Capacity	263
B.2.2 Derating	263
B.3 Grid specifications	264
B.4 Motor connection data	264
B.4.1 EMC compatibility and motor cable length	264
B.5 Applicable standards	265
B.5.1 CE marking	265
B.5.2 EMC compliance declaration	265
B.6 EMC regulations	265
B.6.1 Category C2	266
B.6.2 Category C3	266
Appendix C Dimension drawings	267
C.1 What this chapter contains	267
C.2 Keypad structure	267
C.2.1 Structure chart	267
C.2.2 Installation bracket	267
C.3 VFD structure	268
C.4 Dimensions for VFDs of AC 3PH 380 V (-15%)–440 V (+10%)	269
C.4.1 Wall installation (unit: mm)	269
C.4.2 Flange installation (unit: mm)	271
C.4.3 Floor installation (unit: mm)	272
C.5 Dimensions for VFDs of AC 3PH 520 V (-15%)–690 V (+10%)	273
C.5.1 Wall installation (unit: mm)	273
C.5.2 Flange installation (unit: mm)	274
C.5.3 Floor installation (unit: mm)	275
Appendix D Optional peripheral accessories	277
D.1 What this chapter contains	277

D.2 Peripheral wiring	277
D.3 Power supply	278
D.4 Cables	279
D.4.1 Power cables	279
D.4.2 Control cables	280
D.4.3 Routing the cables	283
D.4.4 Insulation checking	283
D.5 Breaker and electromagnetic contactor	283
D.5.1 AC 3PH 380 V (-15%)–440 V (+10%)	284
D.5.2 AC 3PH 520 V (-15%)–690 V (+10%)	285
D.6 Reactors	285
D.6.1 Reactors for AC 3PH 380 V (-15%)–440 V (+10%)	286
D.6.2 Reactors for AC 3PH 520 V (-15%)–690 V (+10%)	287
D.7 Filter	288
D.7.1 Filter model instruction	289
D.7.2 Filters for AC 3PH 380 V (-15%)–440 V (+10%)	289
D.7.3 Filters for AC 3PH 520 V (-15%)–690 V (+10%)	290
D.8 Braking system	291
D.8.1 Braking component selection	291
D.8.2 Braking resistor cable selection	294
D.8.3 Braking resistor installation	294
Appendix E Further information	296
E.1 Product and service queries	296
E.2 Feedback on INVT VFD manuals	296
E.3 Documents on the Internet	296

1 Safety precautions

1.1 What this chapter contains

Please read this manual carefully and follow all safety precautions before moving, installing, operating and servicing the variable-frequency drive (VFD). If ignored, physical injury or death may occur, or damage may occur to the devices.









If any physical injury or death or damage to the devices occurs for ignoring to the safety precautions in the manual, our company will not be responsible for any damages and we are not legally bound in any manner.

1.2 Safety definition

Danger:	Serious physical injury or even death may occur if not follow relevant requirements
Warning:	Physical injury or damage to the devices may occur if not follow relevant requirements
Note:	Physical hurt may occur if not follow relevant requirements
Qualified electricians:	People working on the device should take part in professional electrical and safety training, receive the certification and be familiar with all steps and requirements of installing, commissioning, operating and maintaining the device to avoid any emergency.

1.3 Warning symbols

Warnings caution you about conditions which can result in serious injury or death and/or damage to the equipment, and advice on how to avoid the danger. Following warning symbols are used in this manual:

Symbols	Name	Instruction	Abbreviation
 Danger	Electrical Danger	Serious physical injury or even death may occur if not follow the relative requirements	
 Warning	General danger	Physical injury or damage to the devices may occur if not follow the relative requirements	
 Do not	Electrostatic discharge	Damage to the PCBA board may occur if not follow the relative requirements	
 Hot sides	Hot sides	Sides of the device may become hot. Do not touch.	
Note	Note	Physical hurt may occur if not follow the relative requirements	Note

1.4 Safety guidelines

	<ul style="list-style-type: none"> ◇ Only qualified electricians are allowed to operate on the VFD. ◇ Do not carry out any wiring and inspection or changing components when the power supply is applied. Ensure all input power supply is disconnected before wiring and checking and always wait for at least the time designated on the VFD or until the DC bus voltage is less than 36 V. Below is the table of the waiting time: 																		
	<table border="1"> <thead> <tr> <th colspan="2">VFD model</th> <th>Minimum waiting time</th> </tr> </thead> <tbody> <tr> <td>380 V</td> <td>1.5 kW–110 kW</td> <td>5 minutes</td> </tr> <tr> <td>380 V</td> <td>132 kW–315 kW</td> <td>15 minutes</td> </tr> <tr> <td>660 V</td> <td>22 kW–132 kW</td> <td>5 minutes</td> </tr> <tr> <td>660 V</td> <td>160 kW–350 kW</td> <td>15 minutes</td> </tr> <tr> <td>660 V</td> <td>400 kW–630 kW</td> <td>25 minutes</td> </tr> </tbody> </table>	VFD model		Minimum waiting time	380 V	1.5 kW–110 kW	5 minutes	380 V	132 kW–315 kW	15 minutes	660 V	22 kW–132 kW	5 minutes	660 V	160 kW–350 kW	15 minutes	660 V	400 kW–630 kW	25 minutes
	VFD model		Minimum waiting time																
	380 V	1.5 kW–110 kW	5 minutes																
	380 V	132 kW–315 kW	15 minutes																
	660 V	22 kW–132 kW	5 minutes																
660 V	160 kW–350 kW	15 minutes																	
660 V	400 kW–630 kW	25 minutes																	
<ul style="list-style-type: none"> ◇ Do not refit the VFD unless authorized; otherwise fire, electric shock or other injury may occur. 																			
<ul style="list-style-type: none"> ◇ The base of the radiator may become hot during running. Do not touch to avoid hurt. 																			
<ul style="list-style-type: none"> ◇ The electrical parts and components inside the VFD are electrostatic. Take measurements to avoid electrostatic discharge during relevant operation. 																			

1.4.1 Delivery and installation

	<ul style="list-style-type: none"> ◇ Please install the VFD on fire-retardant material and keep the VFD away from combustible materials. ◇ Connect the braking optional parts (braking resistors, braking units or feedback units) according to the wiring diagram. ◇ Do not operate on the VFD if there is any damage or components loss to the VFD. ◇ Do not touch the VFD with wet items or your body, otherwise electric shock may occur.
--	---

Note:

- ◇ Select appropriate moving and installing tools to ensure a safe and normal running of the VFD and avoid physical injury or death. For physical safety, the erector should take some mechanical protective measurements, such as wearing exposure shoes and working uniforms.
- ◇ Ensure to avoid physical shock or vibration during delivery and installation.
- ◇ Do not carry the VFD by its cover. The cover may fall off.
- ◇ Install away from children and other public places.

- ✧ Please use the VFD on appropriate condition (See section 4 "Installation guide" for detailed information).
- ✧ Don't allow screws, cables and other conductive items to fall inside the VFD.
- ✧ The leakage current of the VFD may be larger than 3.5 mA during operation. Perform reliable grounding and ensure that the grounding resistance is lower than 10 Ω . The conductivity of the PE grounding conductor is the same as that of the phase conductor. For models higher than 30 kW, the cross sectional area of the PE grounding conductor can be slightly less than the recommended area.
- ✧ R, S and T are the input terminals of the power supply, while U, V and W are the motor terminals. Please connect the input power cables and motor cables with proper techniques; otherwise the damage to the VFD may occur.

1.4.2 Commission and running

	<ul style="list-style-type: none"> ✧ Disconnect all power supplies applied to the VFD before the terminal wiring and wait for at least the designated time after disconnecting the power supply. ✧ High voltage is present inside the VFD during running. Do not carry out any operation except for the keypad setting. It must be noted that the control terminals of the VFDs of 3PH AC 500V and 3PH AC 660V are ELV (Extra Low Voltage) circuit, which cannot be connected directly to the accessible terminals of other devices if no protective isolation measure is taken. ✧ Control terminals of products -5 and -6 are ELV (Extra Low Voltage) circuits. Without protection insulation, you need to avoid directly connecting control terminals to accessible terminals of other devices. ✧ The VFD may start up by itself when P01.21=1. Do not get close to the VFD and motor. ✧ The VFD cannot be used as "Emergency-stop device". ✧ The VFD cannot be used to break the motor suddenly. A mechanical braking device should be provided. ✧ Besides the above items, check to ensure the following ones before the installation and maintenance during the running of the permanent synchronization motor: <ol style="list-style-type: none"> 1. All input power supply is disconnected (including the main power supply and the control power supply). 2. The permanent magnet synchronization motor has stopped running and measured to ensure the output voltage of the VFD is less than 36 V. 3. The waiting time of the permanent magnet synchronization motor after stopping is no less than the time designated and measure to ensure the voltage between + and - is less than 36 V.
--	--

	<p>4. Ensure the permanent magnet synchronization motor does not rotate again because of the external load. It is recommended to install effectively external braking devices or disconnect the electric wiring between the motor and the VFD directly.</p>
--	---

Note:

- ✧ Do not switch on or off the input power supply of the VFD frequently.
- ✧ For VFDs that have been stored for a long time, check and fix the capacitance and try to run it again before utilization (see 8.6.6 "Overheat of the ").
- ✧ Cover the front board before running, otherwise electric shock may occur.



1.4.3 Maintenance and replacement of components

	<ul style="list-style-type: none"> ✧ Only qualified electricians are allowed to perform the maintenance, inspection, and components replacement of the VFD. ✧ Disconnect all power supplies to the VFD before the terminal wiring. Wait for at least the time designated on the VFD after disconnection. ✧ Take measures to avoid screws, cables and other conductive matters to fall into the VFD during maintenance and component replacement.
---	---

Note:

- ✧ Please select proper torque to tighten screws.
- ✧ Keep the VFD, parts and components away from combustible materials during maintenance and component replacement.
- ✧ Do not carry out any isolation and pressure test on the VFD and do not measure the control circuit of the VFD by megameter.
- ✧ Carry out a sound anti-electrostatic protection to the VFD and its internal components during maintenance and component replacement.

1.4.4 Scrap treatment

	<p>The heavy metals inside the VFD should be treated as industrial effluent.</p>
	<p>When the life cycle ends, the product should enter the recycling system. Dispose of it separately at an appropriate collection point instead of placing it in the normal waste stream.</p>

2 Quick start-up

2.1 What this chapter contains

This chapter mainly describes the basic guidelines during the installation and commission procedures on the VFD, which you may follow to install and commission the VFD quickly.

2.2 Unpacking inspection

Check as followings after receiving products:

1. Check that there are no damage and humidification to the package. If not, please contact with local agents or company offices.
2. Check the information on the type designation label on the outside of the package to verify that the drive is of the correct type. If not, please contact with local dealers or company offices.
3. Check that there are no signs of water in the package and no signs of damage or breach to the VFD. If not, please contact with local dealers or company offices.
4. Check the information on the type designation label on the outside of the package to verify that the name plate is of the correct type. If not, please contact with local dealers or company offices.
5. Check to ensure the accessories (including user's manual, control keypad and expansion card) inside the device is complete. If not, please contact with local dealers or company offices.

2.3 Application confirmation

Check the machine before beginning to use the VFD:

1. Check the load type to verify that there is no overload of the VFD during work and check that whether the drive needs to modify the power degree.
2. Check that the actual current of the motor is less than the rated current of the VFD.
3. Check that the control accuracy of the load is the same of the VFD.
4. Check that the incoming supply voltage is correspondent to the rated voltage of the VFD.
5. Check that the communication needs option card or not.

2.4 Environment

Check as followings before the actual installation and usage:

1. Check that the ambient temperature of the VFD is below 40°C. If exceeds, derate 1% for every additional 1°C. Additionally, the VFD cannot be used if the ambient temperature is above 50°C. Note: for the cabinet VFD, the ambient temperature means the air temperature inside the cabinet.
2. Check that the ambient temperature of the VFD in actual usage is above -10°C. If not, add heating facilities. Note: for the cabinet VFD, the ambient temperature means the air temperature inside the cabinet.

3. When the altitude exceeds 1000m, derate by 1% for every increase of 100m. When the altitude exceeds 3000m, consult the local INVT dealer or office for details.
4. Check that the humidity of the actual usage site is below 90% and condensation is not allowed. If not, add additional protection VFDs.
5. Check that the actual usage site is away from direct sunlight and foreign objects cannot enter the VFD. If not, add additional protective measures.
6. Check that there is no conductive dust or flammable gas in the actual usage site. If not, add additional protection to VFDs.

2.5 Installation confirmation

Check as followings after the installation:

1. Check that the load range of the input and output cables meet the need of actual load.
2. Check that the accessories of the VFD are correctly and properly installed. The installation cables should meet the needs of every component (including reactors, input filters, output reactors, output filters, DC reactors, braking units and braking resistors).
3. Check that the VFD is installed on non-flammable materials and the calorific accessories (reactors and braking resistors) are away from flammable materials.
4. Check that all control cables and power cables are run separately and the route complies with EMC requirement.
5. Check that all grounding systems are properly grounded according to the requirements of the VFD.
6. Check that the free space during installation is sufficient according to the instructions in user's manual.
7. Check that the installation conforms to the instructions in user's manual. The drive must be installed in an upright position.
8. Check that the external connection terminals are tightly fastened and the torque is appropriate.
9. Check that there are no screws, cables and other conductive items left in the VFD. If not, get them out.

2.6 Basic commission

Complete the basic commissioning as followings before actual utilization:

1. Select the motor type, set correct motor parameters and select control mode of the VFD according to the actual motor parameters.
2. Autotune. If possible, de-coupled from the motor load to start dynamic autotune. Or if not, static autotune is available.
3. Adjust the ACC/DEC time according to the actual running of the load.
4. Commission the device via jogging and check that the rotation direction is as required. If not, change the rotation direction by changing the wiring of motor.
5. Set all control parameters and then operate.

3 Product overview

3.1 What this chapter contains

The chapter briefly describes the operation principle, product characteristics, layout, name plate and type designation information.

3.2 Basic principles

Goodrive35 series VFDs are wall, floor and flange mountable devices for controlling asynchronous AC induction motors and permanent magnet synchronous motors. It supports wall, fange, and floor installation.

The diagram below shows the simplified main circuit diagram of the VFD. The rectifier converts three-phase AC voltage to DC voltage. The capacitor bank of the intermediate circuit stabilizes the DC voltage. The inverter transforms the DC voltage back to AC voltage for the AC motor. The braking pipe connects the external braking resistor to the intermediate DC circuit to consume the feedback energy when the voltage in the circuit exceeds its maximum limit.

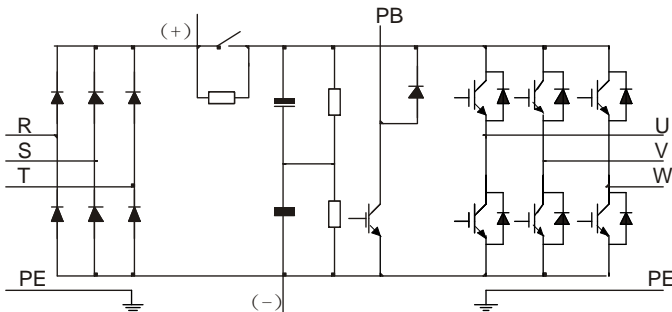

Figure 3-1 Simplified main circuit diagram (VFDs of 380 V ≤ 30 kW)

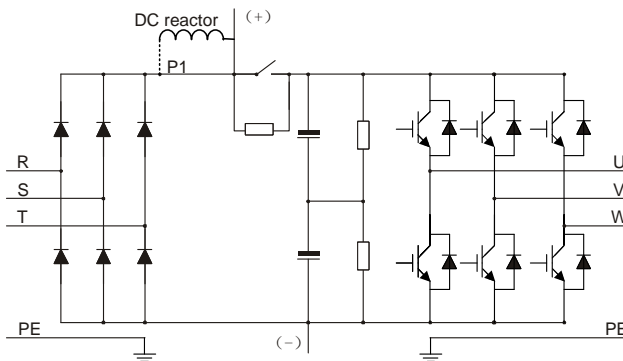

Figure 3-2 Simplified main circuit diagram (VFDs of 380 V ≥ 37 kW)

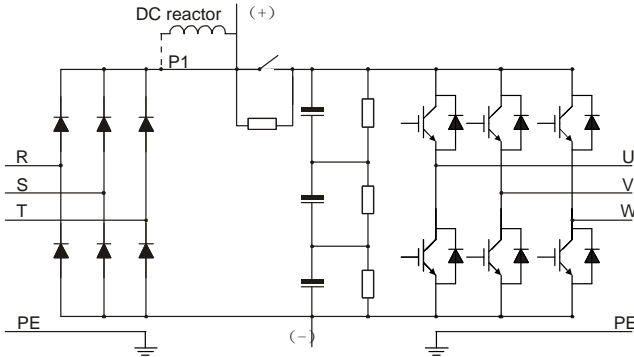

Figure 3-3 Simplified main circuit diagram (VFDs of 660 V)

Note:

- ✧ The VFDs of 380 V (≥ 37 kW) supports external DC reactors and external braking units, but it is necessary to remove the copper tag between P1 and (+) before connecting. DC reactors and braking units are optional.
- ✧ The VFDs of 380 V (≤ 30 kW) supports external braking resistors which are optional.
- ✧ The VFDs of 660 V supports external DC reactors and external braking units, but it is necessary to remove the copper tag between P1 and (+) before connecting. DC reactors and braking units are optional.

3.3 Product specification

Function		Specification
Power input	Input voltage (V)	AC 3PH 380 V (-15%)–440 V (+10%) Rated voltage: 380 V AC 3PH 520 V (-15%)–690 V (+10%) Rated voltage: 660 V
	Input current (A)	Refer to section 3.6 "Rated values"
	Input frequency (Hz)	50 Hz or 60 Hz Allowed range: 47–63 Hz
Power output	Output voltage (V)	0–input voltage
	Output current (A)	Refer to section 3.6 "Rated values"
	Output power (kW)	Refer to section 3.6 "Rated values"
	Output frequency (Hz)	0–400 Hz
Technical control feature	Control mode	SVPWM, Sensorless vector control (SVC), and feedback vector control (FVC)
	Motor type	Asynchronous motor and permanent magnet synchronous motor

Function		Specification
	Adjustable-speed ratio	Asynchronous motor 1: 200 (SVC) synchronous motor 1: 20 (SVC) 1: 1000 (FVC)
	Speed control accuracy	±0.2% (SVC) ±0.02% (FVC)
	Speed fluctuation	± 0.3% (SVC)
	Torque response	<20 ms (SVC), <10 ms (FVC)
	Torque control accuracy	10% (SVC), 5% (FVC)
	Starting torque	Asynchronous motor: 0.25 Hz/150% (SVC) Synchronous motor: 2.5 Hz/150% (SVC) 0 Hz/200% (FVC)
	Overload capability	150% of rated current: 1 minute 180% of rated current: 10 seconds 200% of rated current: 1 second
Running control feature	Frequency setting method	Digital setting, analog setting, pulse frequency setting, multi-step speed running setting, simple PLC setting, PID setting, Modbus communication setting, and PROFIBUS communication setting. Switch between the combination and single setting channel
	Auto-adjustment of the voltage	Keep constant voltage automatically when the grid voltage transients
	Fault protection	Provide more than 30 fault protection functions: overcurrent, overvoltage, undervoltage, overheating, phase loss and overload, etc.
	Restart after rotating speed tracking	Smooth starting of the rotating motor Note: Only for the VFD≥4 kW
Peripheral interface	Terminal analog input resolution	≤ 20 mV
	Terminal switch input resolution	≤ 2 ms
	Analog input	2 (AI1, AI2) 0–10 V/0–20 mA and 1 (AI3) -10–10 V
	Analog output	2 (AO1, AO2) 0–10 V/0–20 mA
	Digital input	8 common inputs, the Max frequency: 1 kHz, internal impedance: 3.3 kΩ; 1 high speed input, the Max frequency: 50 kHz
	Digital output	1 high speed pulse output, the Max frequency: 50 kHz; 1 Y terminal open collector output
	Relay output	2 programmable relay outputs RO1A NO, RO1B NC, RO1C common terminal RO2A NO, RO2B NC, RO2C common terminal Contactor capability: 3 A/AC 250 V, 1 A/DC 30 V

Function		Specification
	Spindle stopping	For spindle positioning and control sequence Internal 7 scale marks and 4 zero marks
	Position reference	External zero-position detection switch positioning Encoder Z phase positioning
	Servo control	Pulse train reference: position control
	Frequency division output	Encoder frequency division output (H1 and H2 VFDs)
	Speed/position mode	Terminal shifting
	Encoder	C1 support 100 kHz, D1 support 500 kHz, H1 support 300 kHz and H2 support 400 kHz
	Positioning	Pulse Z and photoelectric switch positioning. Positioning is accurate without overmodulation.
Others	Mountable method	Wall, flange and floor mountable
	Temperature of the running environment	-10–50°C, if temperature is above 40°C, derate 1% for every additional 1°C.
	Average non-fault time	2 years (25°C ambient temperature)
	Protective degree	IP20
	Pollution level	Level 2
	Cooling	Air-cooling
	Braking unit	Built-in for VFDs of 380 V (≤ 30 kW) External for others
	EMC filter	All products of the 380V series meet the IEC61800-3 C3 requirements. External filters that meet the IEC61800-3 C2 requirements are optional.

3.4 Product nameplate

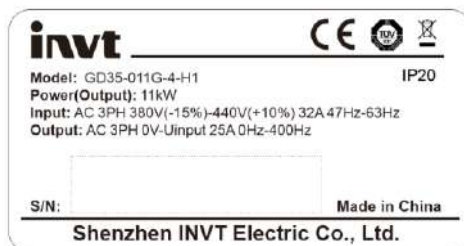

Figure 3-4 Product nameplate

Note: This is an example of the nameplate of standard Goodrive350 products. The CE/TUV/IP20 marking on the top right will be marked according to actual certification conditions.

3.5 Model code

The model code contains information on the VFD. The user can find the model code from the nameplate on the the VFD or from the simplified nameplate.

GD35 - 5R5G - 4 - H1

① ② ③ ④

Figure 3-5 Model code

Key	Sign	Instruction	Content
Abbreviation	①	Abbreviation	Goodrive35: Goodrive35 close-loop vector control VFDs
Rated power	②	Power + Load	5R5: 5.5 kW G: constant torque load
Voltage degree	③	Voltage degree	4: AC 3PH 380 V (-15%)–440 V (+10%) Rated voltage: 380 V 6: AC 3PH 520 V (-15%)–690 V (+10%) Rated voltage: 660 V
Lot number	④	Lot number	C1: Support 24 V incremental encoder D1: Support rotary transformer Optional PG cards with functions of pulse and direction pulse input reference H1: Support 5 V/12 V incremental encoder, differential, push-pull, and open collector signals; Pulse + direction pulse input reference H2: Support 5 V incremental encoder for high-speed differential signal processing; Pulse + direction pulse input reference (specific for machine tools) S1: Support sin/cos encoder, sin/cos (1 Vpp) eg Heidenhain ERN1387; support quadrature pulse input

3.6 Rated values

3.6.1 Rated value of AC 3PH 380 V (-15%)–440 V (+10%)

Model	Output power (kW)	Input current (A)	Output current (A)	Carrier frequency (kHz)
GD35-1R5G-4-C1/D1/H1	1.5	5.0	3.7	1–15 (8)
GD35-2R2G-4-C1/D1/H1	2.2	5.8	5	1–15 (8)
GD35-004G-4-C1/D1/H1/H2/S1	4	13.5	9.5	1–15 (8)
GD35-5R5G-4-C1/D1/H1/H2/S1	5.5	19.5	14	1–15 (8)
GD35-7R5G-4-C1/D1/H1/H2/S1	7.5	25	18.5	1–15 (8)

Model	Output power (kW)	Input current (A)	Output current (A)	Carrier frequency (kHz)
GD35-011G-4-C1/D1/H1/H2/S1	11	32	25	1–15 (8)
GD35-015G-4-C1/D1/H1/H2/S1	15	40	32	1–15 (4)
GD35-018G-4-C1/D1/H1/H2/S1	18.5	47	38	1–15 (4)
GD35-022G-4-C1/D1/H1/H2/S1	22	56	45	1–15 (4)
GD35-030G-4-C1/D1/H1/H2/S1	30	70	60	1–15 (4)
GD35-037G-4-C1/D1/H1/S1	37	80	75	1–15 (4)
GD35-045G-4-C1/D1/H1/S1	45	94	92	1–15 (4)
GD35-055G-4-C1/D1/H1/S1	55	128	115	1–15 (4)
GD35-075G-4-C1/D1/H1/S1	75	160	150	1–15 (2)
GD35-090G-4-C1/D1/H1/S1	90	190	180	1–15 (2)
GD35-110G-4-C1/D1/H1/S1	110	225	215	1–15 (2)
GD35-132G-4-C1/D1/H1/S1	132	265	260	1–15 (2)
GD35-160G-4-C1/D1/H1/S1	160	310	305	1–15 (2)
GD35-185G-4-C1/D1/H1/S1	185	345	340	1–15 (2)
GD35-200G-4-C1/D1/H1/S1	200	385	380	1–15 (2)
GD35-220G-4-C1/D1/H1/S1	220	430	425	1–15 (2)
GD35-250G-4-C1/D1/H1/S1	250	485	480	1–15 (2)
GD35-280G-4-C1/D1/H1/S1	280	545	530	1–15 (2)
GD35-315G-4-C1/D1/H1/S1	315	610	600	1–15 (2)

Note:

- ✧ The input current of VFDs 1.5–315 kW is detected when the input voltage is 380 V and there is no DC reactors and input/output reactors.
- ✧ The rated output current is defined when the output voltage is 380 V.
- ✧ The output current cannot exceed the rated output current and the output power cannot exceed the rated output power in the voltage range.

3.6.2 Rated value of AC 3PH 520 V (-15%)–690 V (+10%)

Model	Output power (kW)	Input current (A)	Output current (A)	Carrier frequency (kHz)
GD35-022G-6-C1/D1/H1	22	35	27	1–15 (4)
GD35-030G-6-C1/D1/H1	30	40	34	1–15 (4)
GD35-037G-6-C1/D1/H1	37	47	42	1–15 (4)
GD35-045G-6-C1/D1/H1	45	52	54	1–15 (4)

Model	Output power (kW)	Input current (A)	Output current (A)	Carrier frequency (kHz)
GD35-055G-6-C1/D1/H1	55	65	62	1–15 (4)
GD35-075G-6-C1/D1/H1	75	85	86	1–15 (2)
GD35-090G-6-C1/D1/H1	90	95	95	1–15 (2)
GD35-110G-6-C1/D1/H1	110	118	131	1–15 (2)
GD35-132G-6-C1/D1/H1	132	145	147	1–15 (2)
GD35-160G-6-C1/D1/H1	160	165	163	1–15 (2)
GD35-185G-6-C1/D1/H1	185	190	198	1–15 (2)
GD35-200G-6-C1/D1/H1	200	210	216	1–15 (2)
GD35-220G-6-C1/D1/H1	220	230	240	1–15 (2)
GD35-250G-6-C1/D1/H1	250	255	274	1–15 (2)
GD35-280G-6-C1/D1/H1	280	286	300	1–15 (2)
GD35-315G-6-C1/D1/H1	315	334	328	1–15 (2)
GD35-350G-6-C1/D1/H1	350	360	380	1–15 (2)
GD35-400G-6-C1/D1/H1	400	411	426	1–15 (2)
GD35-500G-6-C1/D1/H1	500	518	540	1–15 (2)
GD35-560G-6-C1/D1/H1	560	578	600	1–15 (2)
GD35-630G-6-C1/D1/H1	630	655	680	1–15 (2)

Note:

- ✧ The input current of VFDs 22–350 kW is detected when the input voltage is 660 V and there is no DC reactors and input/output reactors.
- ✧ The input current of VFDs 400–630 kW is detected when the input voltage is 660 V and there are input reactors.
- ✧ The rated output current is defined when the output voltage is 660 V.
- ✧ The output current cannot exceed the rated output current and the output power cannot exceed the rated output power in the voltage range.

3.7 Structure diagram

The VFD layout is shown below (take 380 V 30 kW as an example).

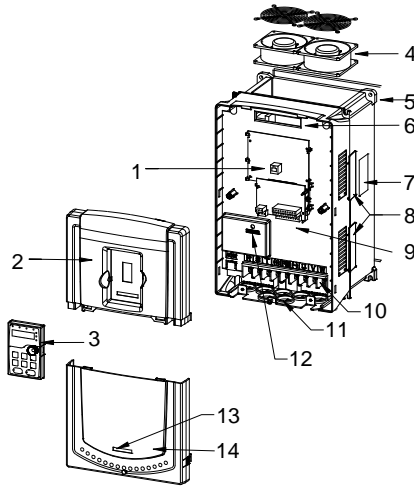



Figure 3-6 Structure diagram

Serial No.	Name	Illustration
1	Keypad interface	Connect the keypad
2	Upper cover plate	Protect the internal parts and components
3	Keypad	See Chapter 5 "Keypad operation procedures" for detailed information
4	Cooling fan	See Chapter 9 "Routine maintenance" for detailed information
5	Wiring interface	Connect to the control board and the drive board
6	Nameplate	See Chapter 3 "Product overview" for detailed information
7	Ventilation hole cover plate	Optional. The ventilation hole cover plate will increase the protection level as well as the internal temperature of the VFD, which requiring the VFD to be used under derating.
8	Control terminals	See Chapter 4 "Installation guide" for detailed information
9	Main circuit terminals	See Chapter 4 "Installation guide" for detailed information
10	Main circuit cable inlet	Fix the main circuit cable
11	POWER light	Power indicator
12	Simple nameplate	See section 3.5 "Model code" for detailed information
13	Lower cover plate	Protect the internal parts and components

4 Installation guide

4.1 What this chapter contains

The chapter describes the mechanical installation and electric installation.

	<ul style="list-style-type: none"> ◇ Only qualified electricians are allowed to carry out what described in this chapter. Please operate as the instructions in Chapter 1 "Safety precautions". Ignoring these may cause physical injury or death or damage to the devices. ◇ Ensure the power supply of the VFD is disconnected during the operation. Wait for at least the time designated until the POWER indicator is off after the disconnection if the power supply is applied. It is recommended to use the multimeter to monitor that the DC bus voltage of the drive is under 36 V. ◇ The installation and design of the VFD should be complied with the requirement of the local laws and regulations in the installation site. If the installation infringes the requirement, our company will exempt from any responsibility. Additionally, if users do not comply with the suggestion, some damage beyond the assured maintenance range may occur.
---	--

4.2 Mechanical installation

4.2.1 Installation environment

The installation environment is the safeguard for a full performance and long-term stable functions of the VFD. Check the installation environment as follows:

Environment	Conditions
Installation site	Indoor
Environment temperature	<ul style="list-style-type: none"> ◇ -10—+50°C ◇ If the ambient temperature of the VFD is above 40°C, derate 1% for every additional 1°C. ◇ It is not recommended to use the VFD if the ambient temperature exceeds 50°C. ◇ In order to improve the reliability of the device, do not use the VFD if the ambient temperature changes frequently. ◇ Please provide cooling fan or air conditioner to control the internal ambient temperature below the required one if the VFD is used in a close space such as in the control cabinet. ◇ When the temperature is too low, if the VFD needs to restart to run after a long stop, it is necessary to provide an external heating device to increase the internal temperature, otherwise damage to the devices may occur.
Humidity	<ul style="list-style-type: none"> ◇ RH ≤ 90%, no condensation is allowed. ◇ The max relative humidity should be equal to or less than 60% in corrosive air.

Environment	Conditions
Storage temperature	-30~+60°C
Running environment condition	Install the VFD on a site described as follows: <ul style="list-style-type: none"> ✧ Far away from electromagnetic radiation sources; ✧ Without oil mist, corrosive gas, flammable gas, or other contaminative air; ✧ Keeping foreign objects, such as metal power, dust, oil, and water, from dropping into the VFD (do not install it on the flammable materials such as wood); ✧ Without radioactive and flammable materials; ✧ Without harmful gas or liquid; ✧ With less salt spray; ✧ Without direct sunlight.
Altitude	<ul style="list-style-type: none"> ✧ When the altitude exceeds 1000m, derate by 1% for every increase of 100m. ✧ When the altitude exceeds 3000m, consult the local INVT dealer or office for details.
Vibration	$\leq 5.8\text{m/s}^2$ (0.6g)
Installation direction	The VFD should be installed in upright position to ensure sufficient cooling effect.

Note:

- ✧ Goodrive35 series VFDs should be installed in a clean and well ventilated environment according to enclosure classification.
- ✧ Cooling air must be clean, free from corrosive materials and electrically conductive dust.

4.2.2 Installation direction

The VFD may be installed on the wall or in a cabinet.

The VFD must be installed in an upright position. Check the installation site according to the requirements below. Refer to Appendix C "Dimension drawings" for frame details.

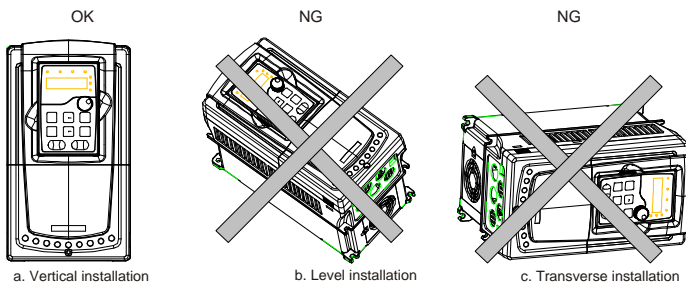

Figure 4-1 Installation direction of the VFD

4.2.3 Installation manner

The VFD can be installed in three different ways, depending on the frame size:

- a) Wall mounting (for the VFDs of 380 V ≤ 315 kW and the VFDs of 660 V ≤ 350 kW)
- b) Flange mounting (for the VFDs of 380 V ≤ 200 kW and the VFDs of 660 V ≤ 220 kW)
- c) Floor mounting (for the VFDs of 380 V 220-500 kW and the VFDs of 660 V 250-630 kW)

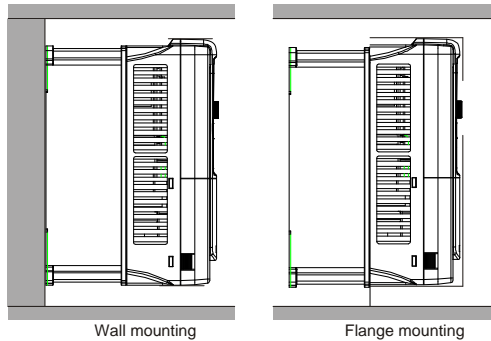

Figure 4-2 Installation manner

- (1) Mark the hole location. The location of the holes is shown in the Appendix C "Dimension drawings".
- (2) Fix the screws or bolts to the marked locations.
- (3) Put the VFD against the wall.
- (4) Tighten the screws in the wall securely.

Note:

- ✧ The flange installation of the VFDs of 380 V 1.5-30 kW need flange board, while the flange installation of the VFDs of 380 V 37-200 kW and 660 V 22-220 kW does not need.
- ✧ The VFDs of 380 V 220-315 kW and 660 V 250-350 kW need optional bases and there is an input AC reactor (or DC reactor) and output AC reactor in the base.

4.2.4 Single installation

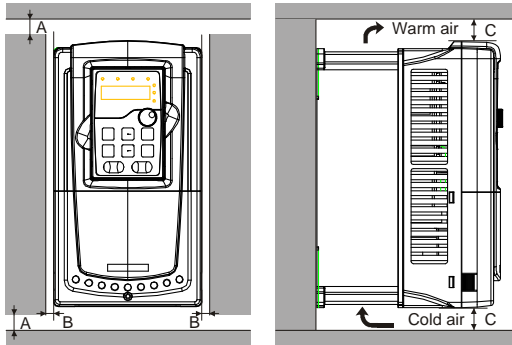

Figure 4-3 Single installation

Note: The minimum space of B and C is 100mm.

4.2.5 Multiple installations

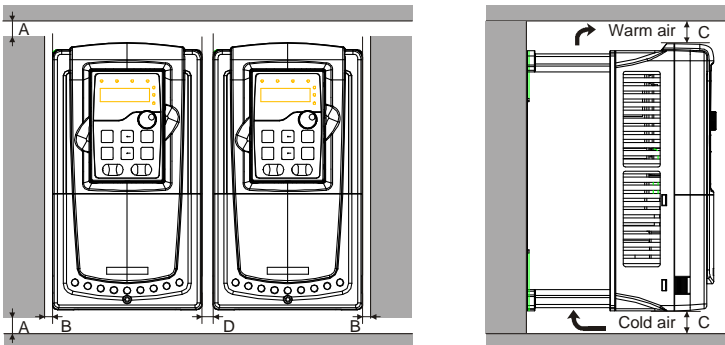

Figure 4-4 Parallel installation

Note:

- ◇ When installing VFDs with different sizes, align with the upper part of the VFD before installation for the convenience of future maintenance;
- ◇ The minimum space of B, D and C is 100mm.

4.2.6 Vertical installation

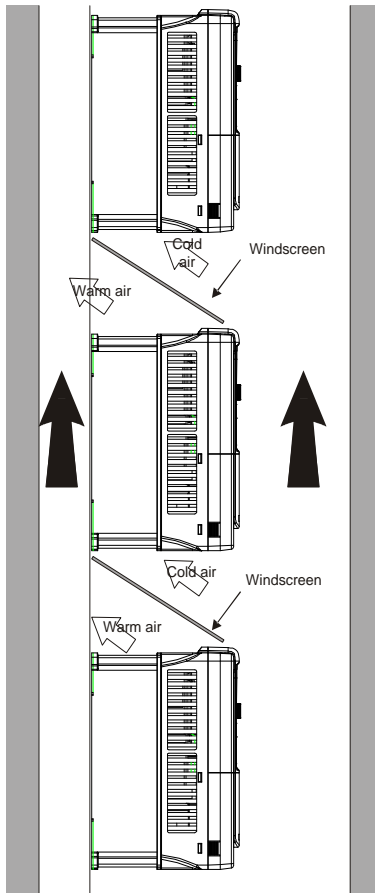

Figure 4-5 Vertical installation

Note: Windscreen should be installed in vertical installation for avoiding mutual impact and insufficient cooling.

4.2.7 Tilt installation

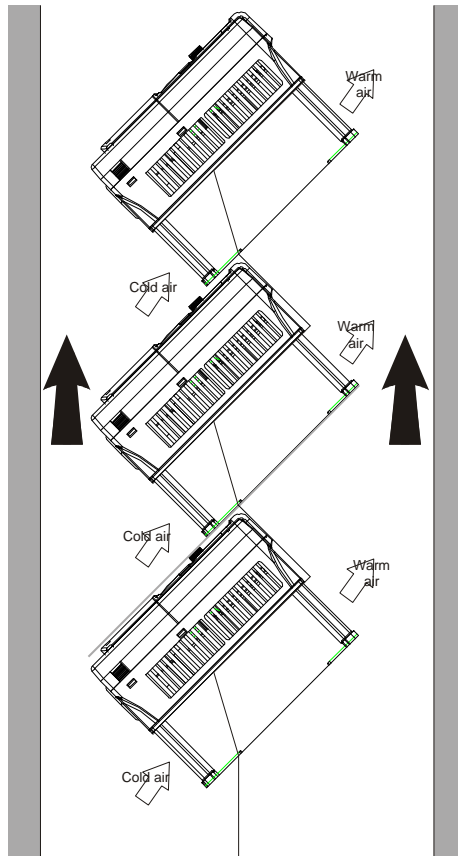

Figure 4-6 Tilt installation

Note: Ensure the separation of the wind input and output channels in tilt installation for avoiding mutual impact.

4.3 Standard wiring

4.3.1 Main circuit connection diagram

4.3.1.1 For VFDs of AC 3PH 380 V (-15%)–440 V (+10%)

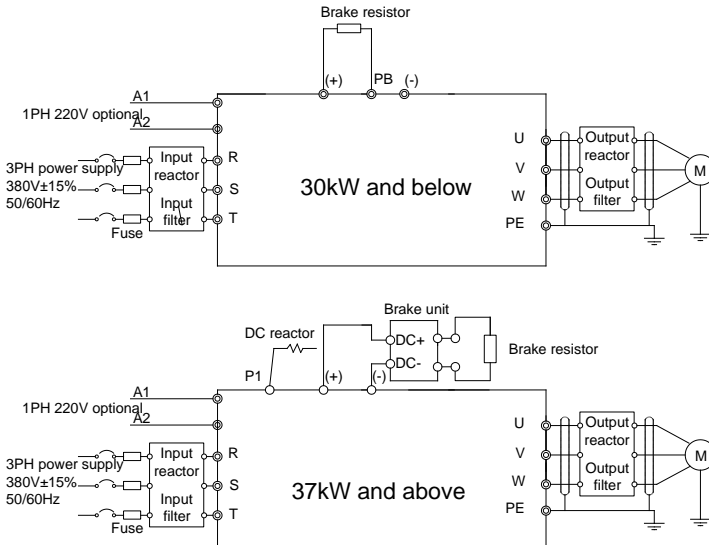

Figure 4-7 Connection diagram of main circuit for the VFDs of 380 V

Note:

- ✧ The fuse, DC reactor, braking unit, braking resistor, input reactor, input filter, output reactor, and output filter are optional parts. Please refer to Appendix D "Optional peripheral accessories" for detailed information.
- ✧ A1 and A2 are optional parts.
- ✧ P1 and (+) are short circuited in factory for the VFDs of 380 V (≥ 37 kW), if need to connect with the DC reactor, please remove the contact tag between P1 and (+).
- ✧ Before connecting the braking resistor cable, remove the yellow labels of PB, (+), and (-) from the terminal blocks. Otherwise, poor connection may occur.

4.3.1.2 For VFDs of AC 3PH 520 V (-15%)–690 V (+10%)

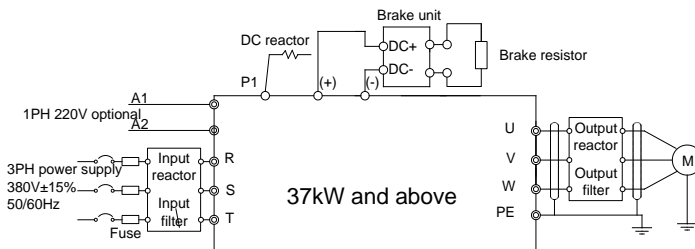

Figure 4-8 Connection diagram of main circuit for the VFDs of 660 V

Note:

- ✧ The fuse, DC reactor, braking unit, braking resistor, input reactor, input filter, output reactor, output filter are optional parts. Please refer to Appendix D "Optional peripheral accessories" for detailed information.
- ✧ P1 and (+) are short circuited in factory, if need to connect with the DC reactor, please remove the contact tag between P1 and (+).
- ✧ When connecting the braking resistor, take off the yellow warning label marked with (+) and (-) on the terminal bar before connecting braking resistor wire, otherwise, poor contact will occur.

4.3.2 Terminals figure of main circuit

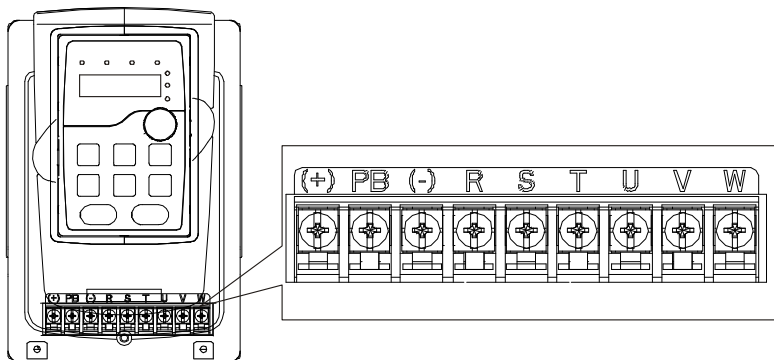

Figure 4-9 Terminals of main circuit for the VFDs of 380 V 1.5–2.2 kW

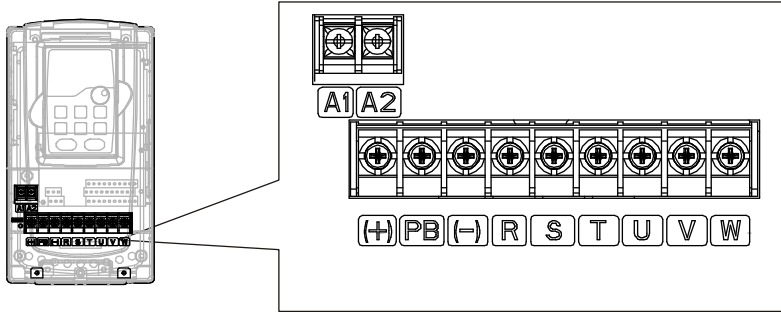

Figure 4-10 Terminals of main circuit for the VFDs of 380 V 4–5.5 kW

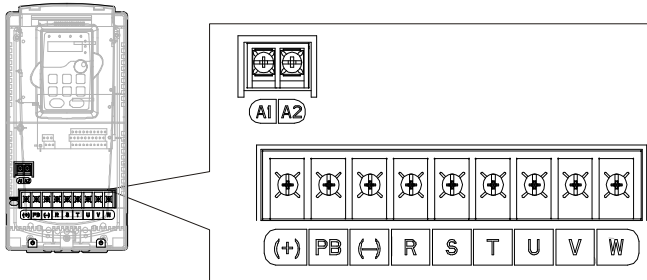

Figure 4-11 Terminals of main circuit for the VFDs of 380 V 7.5–11 kW

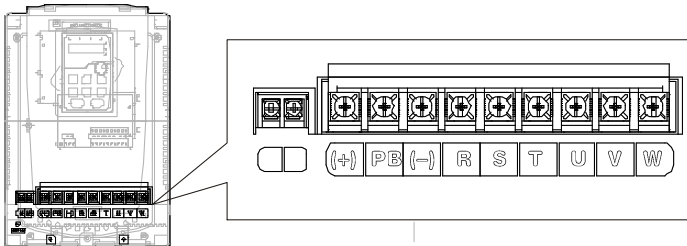

Figure 4-12 Terminals of main circuit for the VFDs of 380 V 15–18 kW

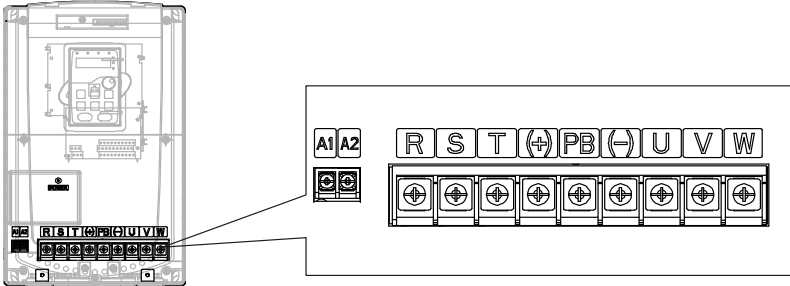

Figure 4-13 Terminals of main circuit for the VFDs of 380 V 22–30 kW

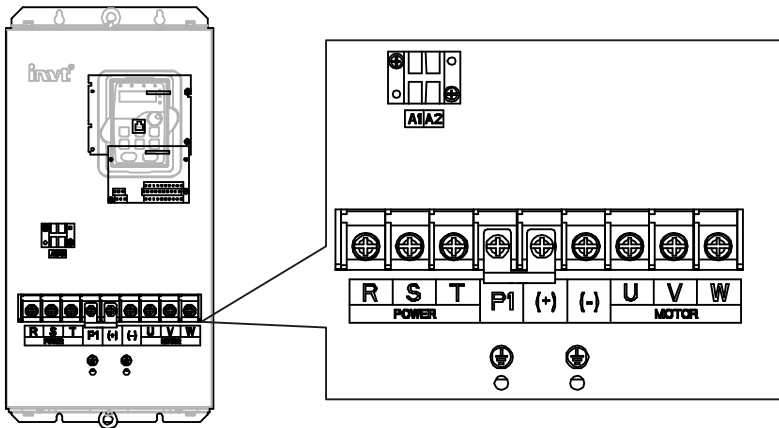

Figure 4-14 Terminals of main circuit for the VFDs of 380 V 37–55 kW and 660 V 22–45 kW

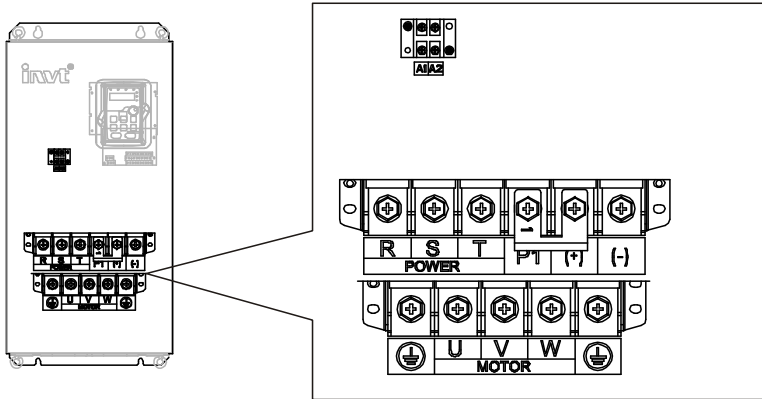

Figure 4-15 Terminals of main circuit for the VFDs of 380 V 75–110 kW and 660 V 55–132 kW

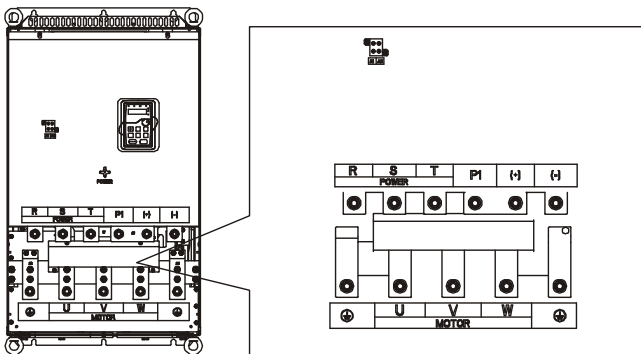

Figure 4-16 Terminals of main circuit for the VFDs of 380 V 132–200 kW and 660 V 160–220 kW

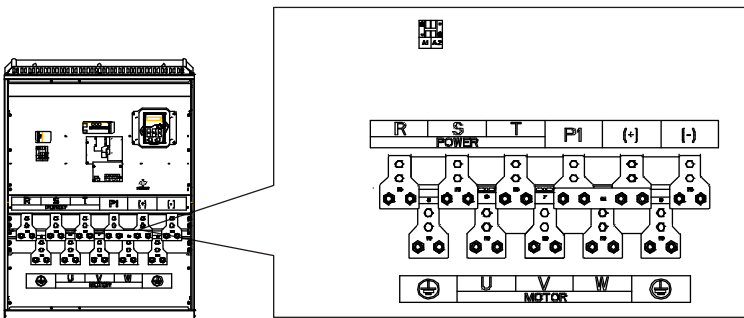

Figure 4-17 Terminals of main circuit for the VFDs of 380 V 220–315 kW and 660 V 250–350 kW

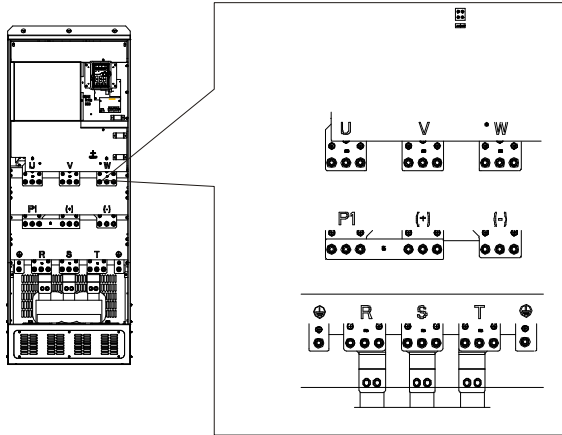

Figure 4-18 Terminals of main circuit for the VFDs of 660 V 400–630 kW

Terminal	Terminal name		Function
	380 V ≤30 kW	380 V ≥37 kW 660 V	
R, S, T	Power input of the main circuit		3-phase AC input terminals which are generally connected with the power supply.
U, V, W	The VFD output		3-phase AC output terminals which are generally connected with the motor.
P1	/	DC reactor terminal 1	P1 and (+) are connected with the terminals of DC reactor. (+) and (-) are connected with the terminals of braking unit. PB and (+) are connected with the terminals of braking resistor.
(+)	Braking resistor 1	DC reactor terminal 2, braking unit terminal 1	
(-)	/	Braking unit terminal 2	
PB	Braking resistor 2	/	
PE	380 V: the grounding resistor is less than 10Ω 660 V: the grounding resistor is less than 10Ω		Protective grounding terminals, every machine is provided 2 PE terminals as the standard configuration. These terminals should be grounded with proper techniques.
A1 and A2	Control power supply terminal		Optional for the VFDs of 380 V, standard for the VFDs of 660 V (with external 220 V control power) If no voltage is present on the main circuit, more convenient and safer commissioning is available through the auxiliary power supply.

Note:

- ✧ It is not recommended to use an asymmetrically constructed motor cable. If there is a symmetrically constructed grounding conductor in the motor cable in addition to the conductive shield, connect the grounding conductor to the grounding terminal at the VFD and motor ends.
- ✧ Braking resistor, braking unit and DC reactor are optional parts.
- ✧ Route the motor cable, input power cable and control cables separately.
- ✧ If the terminal description is "/", the machine does not provide the terminal as the external terminal.
- ✧ GD series VFDs cannot share the DC bus with CH series VFDs.
- ✧ When sharing the DC bus, the VFDs must be the same in power and must be simultaneously powered on or off.
- ✧ In shared DC bus running mode, current balance on the VFD input side must be considered during wiring, and equalizing reactors are recommended to be configured.

4.3.3 Wiring of terminals in main circuit

1. Connect the ground wire of the input power cable to the ground terminal (PE) of the VFD, and connect the 3PH input cable to the terminals R, S, and T, and fasten them up.
2. Connect the ground wire of the motor cable to the ground terminal of the VFD, and connect the 3PH motor cable to the terminals U, V, and W, and fasten them up.
3. Connect the braking resistor and other accessories that are equipped with cables to the specified positions.
4. Fasten all the cables outside of the VFD mechanically, if possible.

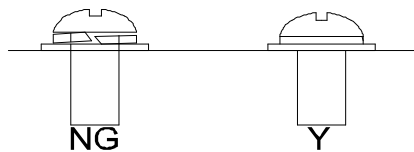

The screw is not fastened The screw is not fastened

Figure 4-19 Diagram of screw installation

4.4 Standard wiring (control circuit)

4.4.1 Wiring diagram of basic control circuit

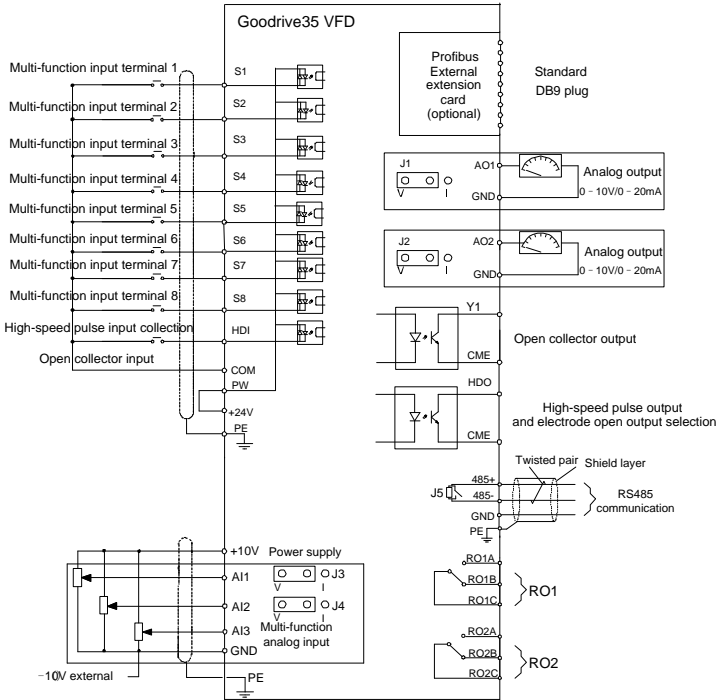
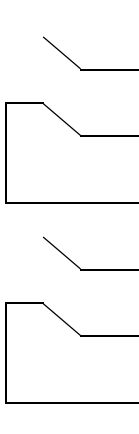

Figure 4-20 Wiring of control circuit

Terminal name	Description
+10V	Local power supply +10 V
AI1	1. Input range: AI1/AI2 voltage and current can be chosen: 0–10 V/0–20mA; AI1 can be shifted by J3 while AI2 can be shifted by J4; AI3: -10 V→+10 V 2. Input impedance: voltage input: 20kΩ; current input: 500Ω 3. Resolution: the minimum one is 5m V when 10 V corresponds to 50 Hz 4. Deviation ±1%, 25°C
AI2	
AI3	
GND	+10 V reference null potential

Terminal name	Description
AO1	1. Output range: 0–10 V or -20–20mA; The voltage or the current output is depended on the jumper. AO1 is switched by J1 and AO2 is switched by J2 2. Deviation±1%, 25°C
AO2	



Terminal name	Description
RO1A	RO1 relay output; RO1A is NO, RO1B is NC, RO1C is common port Contact capacity: 3A/AC250V, 1A/DC30V
RO1B	
RO1C	
RO2A	RO2 relay output; RO2A is NO, RO2B is NC, RO2C is common port Contact capacity: 3A/AC250V, 1A/DC30V
RO2B	
RO2C	

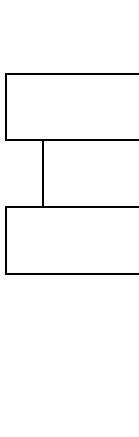

Terminal name	Description
HDO	1. Switch capacity: 50mA/30V; 2. Range of output frequency: 0–50kHz
COM	
CME	Common port of open collector output
Y	1. Switch capacity: 50mA/30V; 2. Range of output frequency: 0–1kHz
485+	
485-	For 485 communication port, 485 differential signal port and standard 485 communication interfaces, use twisted pairs or shielded cables.

Terminalname	Description	
PE	Grounding terminal	
PW	Provide input digital working power from external to internal; Voltage range: 12–30V	
24V	The VFD provides user power; the maximum output current is 200mA	
COM	Common port of +24V	
S1	Digital input 1	1. Internal impedance: 3.3kΩ 2. Accept 12–30V voltage input 3. This terminal is bi-directional input terminal and supports NPN/PNP connection modes 4. Max. input frequency: 1kHz 5. All are programmable digital input terminals, and users can set the terminal function via function codes
S2	Digital input 2	
S3	Digital input 3	
S4	Digital input 4	
S5	Digital input 5	
S6	Digital input 6	
S7	Digital input 7	
S8	Digital input 8	
HDI	Besides S1–S8 functions, it can also act as high frequency pulse input channel Max. input frequency: 50kHz	

4.4.2 C1 terminal (EC-PG301-24) instruction and the wiring diagram

4.4.2.1 Terminal arrangement

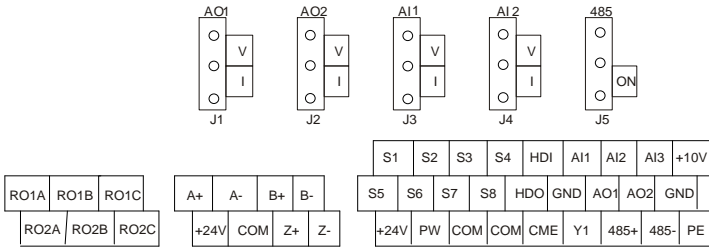

4.4.2.2 Terminal instruction

Terminal name	Instruction
+24 V	Encoder power supply. It can provide power supply of 24 V, 200 mA.
A+, A-, B+, B-, Z+, Z-	Support encoder signal differential, push-pull, and open collector input.
COM1	Power supply ground of the encoder

Note: Refer to section 4.3.1 for detailed information of AO1, AO2, AI1, AI2, 485 and other terminals.

4.4.2.3 Wiring diagram

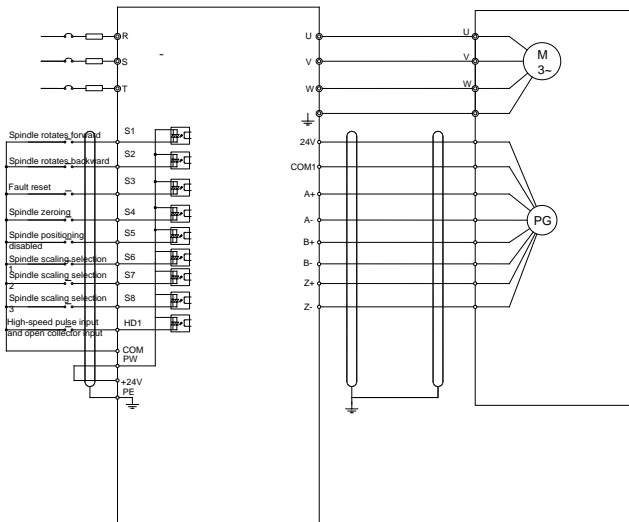

4.4.3 D1 terminal (EC-PG304-05) instruction and the wiring diagram

4.4.3.1 Terminal arrangement

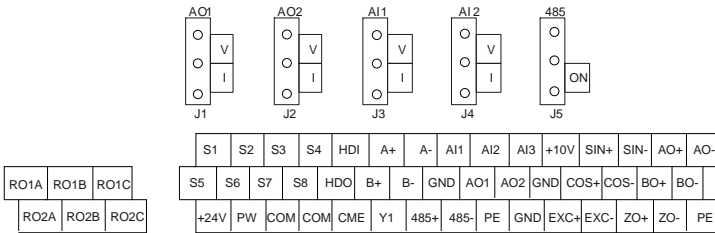

4.4.3.2 Terminal instruction

Terminal name	Instruction
EXC+EXC-	Exciting signal of 10k Hz, and max. output current of 100 mA.
SIN+, SIN-, COS+ and COS-	Encoder differential signal input.
A+, A-, B+, B-	Pulse reference signal, default as 5 V input. External current-limiting resistor is needed when the input voltage is above 10 V.
AO+, AO-, BO+, BO-, ZO+, ZO-	Frequency-divided output of encoder signals, 5 V differential signals Frequency dividing ratio: 1:1

Note: Refer to section 4.3.1 for detailed information of AO1, AO2, AI1, AI2, 485 and other terminals.

4.4.3.3 Wiring diagram

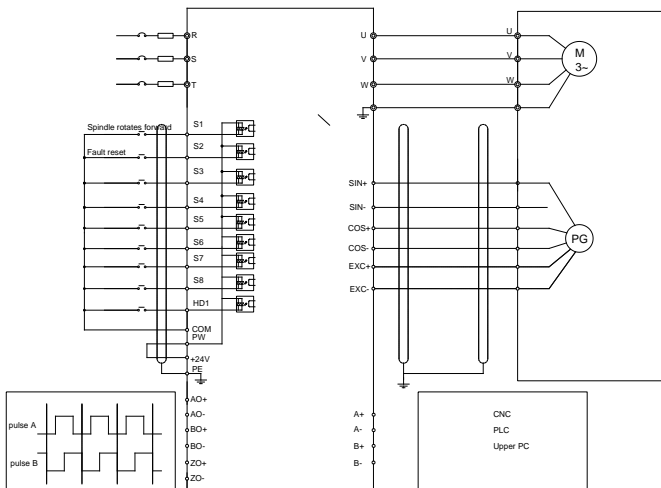

4.4.4 H1 terminal (EC-PG305-12) instruction and the wiring diagram

4.4.4.1 Terminal arrangement

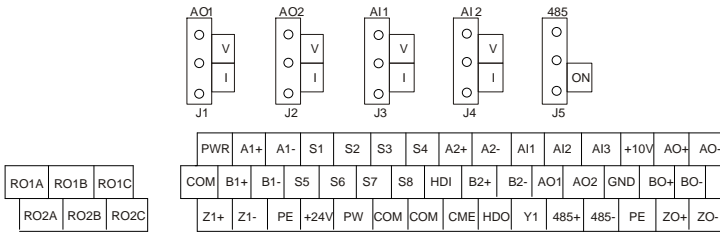

4.4.4.2 Terminal instruction

Terminal name	Instruction
PWR	Power supply, provide 5 V/12 V, 200mA power supply
A1+, A1-, B1+, B1-, Z1+, Z1-	Encoder differential, open collector, and push-pull signal input
A2+, A2-, B2+, B2-,	Support encoder differential, open collector, and push-pull pulse reference signal. Pulse reference signal, default as 5 V input. External current-limiting resistor is needed when the input voltage is above 10 V
AO+, AO-, BO+, BO-, ZO+ and ZO-	Frequency-divided output of encoder pulse signals, 5 V differential signals Frequency dividing ratio: 1:1
COM	Power supply ground of the encoder

Note: Refer to section 4.3.1 for detailed information of AO1, AO2, AI1, AI2, 485 and other terminals.

4.4.4.3 Wiring diagram

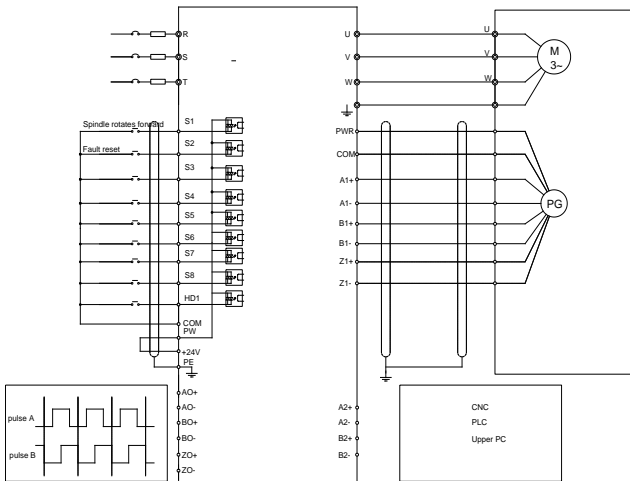

4.4.5 H2 terminal (EC-PG305-05) instruction and the wiring diagram

4.4.5.1 Terminal arrangement

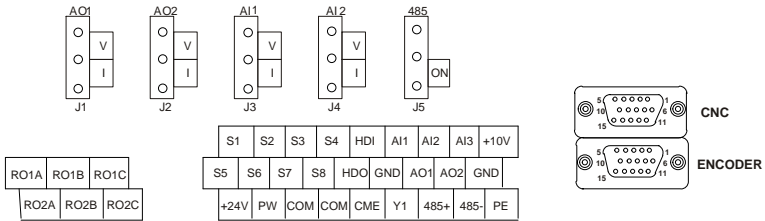

4.4.5.2 Interfaces instruction

DB15 (CNC)	CNC system interface signal	DB15 (ENCODER)	Encoder interface signal
1	AO+	1	+5 V
2	AO-	2	A1+
3	BO+	3	B1+
4	BO-	4	Z1+
5	ZO+	5	U+
6	ZO-	6	U-
7	CME	7	V+
8	COM	8	V-
9	S7	9	GND
10	S8	10	A1-
11	A2+	11	B1-
12	A2-	12	Z1-
13	B2+	13	W+
14	B2-	14	W-
15	COM	15	

4.4.5.3 Terminal instruction

Terminal name (CNC)	Instruction
A2+, A2-, B2+, B2-	5 V differential pulse + direction reference signal, Support 400 kHz at maximum
AO+, AO-, BO+, BO-, ZO+, ZO-	Frequency-divided output of encoder pulse signals, 5 V differential signals Frequency dividing ratio: 1:1
CME, COM	Alarm output (If use this function, it is necessary to short-connect Y terminal to +24 V terminal, and remove the tag between CME and COM terminal)

Terminal name (ENCODER)	Instruction
S7	Common digital input
+5 V, GND	Encoder power supply, support 5 V±5%, 200mA power
A1+, A1-, B1+, B1-, Z1+, Z1-	The encoder differential input signal, support 400 kHz at maximum
U+, U-, V+, V-, W+, W-	Difference angle input signal input of UVW encoders (not for incremental encoders)

Note: Refer to section 4.3.1 for detailed information of AO1, AO2, AI1, AI2, 485 and other terminals.

4.4.5.4 Wiring diagram

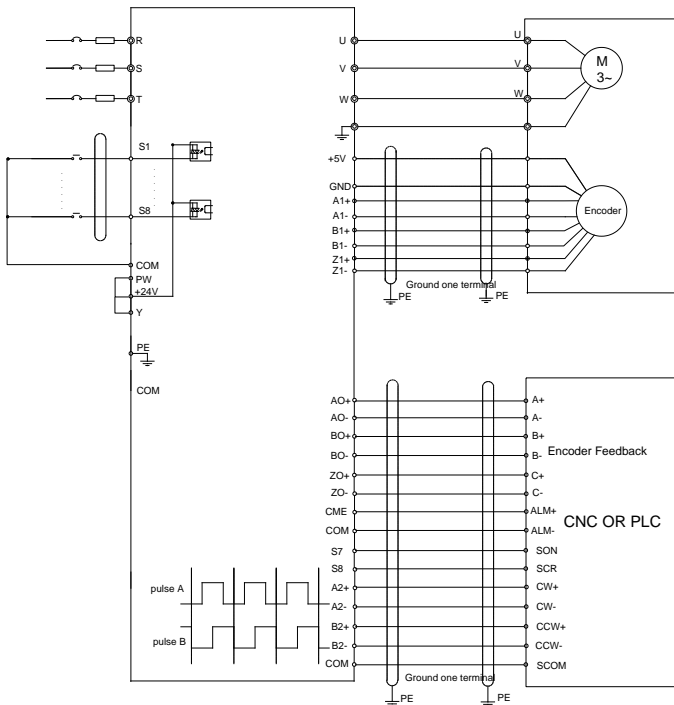

4.4.6 S1 terminal (EC-PG302-05) instruction

4.4.6.1 Sin/cos terminal layout

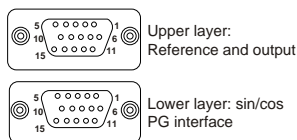
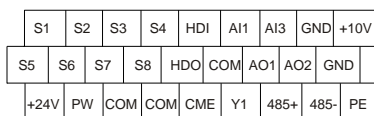

4.4.6.2 DB15 interface instruction

DB15 (upper layer)	Pulse reference and output interface signal	DB15 (Lower layer)	Sin/cos encoder interface signal
1	AO+	1	B-
2	AO-	2	Null
3	BO+	3	R+
4	BO-	4	R-
5	ZO+	5	A+
6	ZO-	6	A-
7	/	7	0 V
8	/	8	B+
9	/	9	5 V
10	/	10	C-
11	A2+	11	C+
12	A2-	12	D+
13	B2+	13	D-
14	B2-	14	Null
15	/	15	Null

4.4.6.3 DB15 pin function instruction

Name of upper layer terminal (pulse reference interface)	Instruction
A2+, A2-, B2+, B2-,	5 V differential quadrature pulse reference signal, support 400 kHz at maximum
AO+, AO-, BO+, BO-, ZO+, ZO-	Frequency-divided output of encoder pulse signals, 5 V differential signals Frequency dividing ratio: 1:1
Name of lower layer terminal (sin/cos encoder interface)	Instruction
+5 V, 0 V	Encoder power, can provide 5 V±5%, 200mA.
A+, A-, B+, B-, C+, C-, D+, D-, R+, R-	Sin/cos encoder signal input, support SINA/SINB/SINC/SIND 0.8–1.2 Vpp, SINR 0.2–0.85 Vpp, 200 kHz at maximum

4.4.7 Input/output signal connection diagram

Use U-type tag to set the NPN/PNP mode and internal/external power sources. The default setting is NPN internal mode.

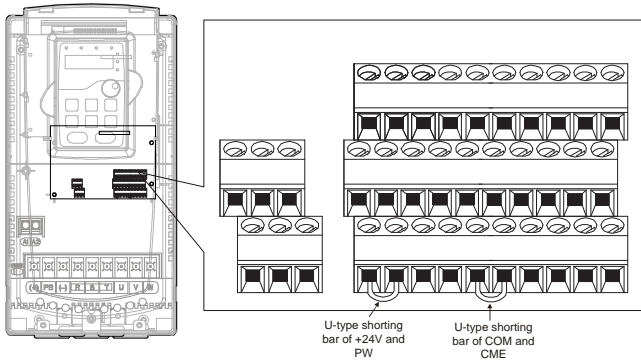

Figure 4-21 U-shaped contact tag

If the signal is from NPN transistor, please set the U-shaped contact tag between +24 V and PW as below according to the used power supply.

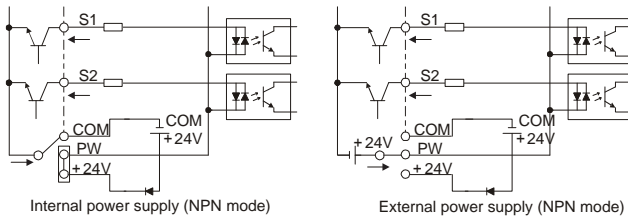

Figure 4-22 NPN modes

If the signal is from PNP transistor, please set the U-shaped contact tag as below according to the used power supply.

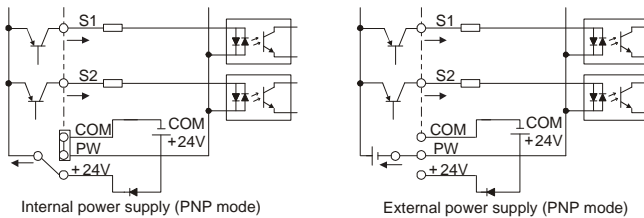

Figure 4-23 PNP modes

4.5 Wiring protection

4.5.1 Protecting the VFD and input power cable in short-circuit situations

Protect the VFD and input power cable in short circuit situations and against thermal overload.

Arrange the protection according to the following guidelines.

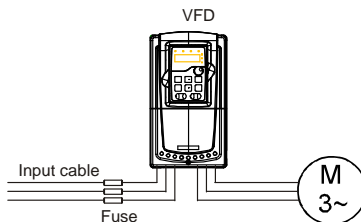



Fig 4-25 Fuse configuration

Note: Select the fuse as the manual indicated. The fuse will protect the input power cable from damage in short-circuit situations. It will protect the surrounding devices when the internal of the VFD is short circuited.

4.5.2 Protecting the motor and motor cable in short-circuit situations

The VFD protects the motor and motor cable in a short-circuit situation when the motor cable is dimensioned according to the rated current of the VFD. No additional protection devices are needed.

	<p>If the VFD is connected to multiple motors, a separate thermal overload switch or a circuit breaker must be used for protecting each cable and motor. These devices may require a separate fuse to cut off the short-circuit current.</p>
---	--

4.5.3 Protecting the motor against thermal overload

According to regulations, the motor must be protected against thermal overload and the current must be switched off when overload is detected. The VFD includes a motor thermal protection function that protects the motor and closes the output to switch off the current when necessary.

4.5.4 Implementing a bypass connection

It is necessary to set power frequency and variable frequency conversion circuits for the assurance of continuous normal work of the VFD if faults occur in some significant situations.

In some special situations, for example, if it is only used in soft start, the VFD can be converted into power frequency running after starting and some corresponding bypass should be added.

	<p>Never connect the supply power to the VFD output terminals U, V and W. Power line voltage applied to the output can result in permanent damage to the VFD.</p>
---	---

If frequent shifting is required, employ mechanically connected switches or contactors to ensure that the motor terminals are not connected to AC power line and VFD output terminals simultaneously.

5 Keypad operation procedures

5.1 What this chapter contains

This chapter describes the keys, indicators, and display of the keypad, and how to view and modify function code settings through the keypad.

5.2 Keypad

The keypad is used to control Goodrive35 series VFDs, read the state data, and modify parameters. If you need to use the keypad in another place rather than on the VFD, use a network cable with a standard RJ45 crystal head as the expansion cable.

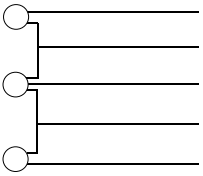









Figure 5-1 Keypad

Note:

- ✧ The LED keypad is standard but the LCD keypad which can support various languages, parameters copy, 10-line displaying is optional and its installation dimension is compatible with the LED keypad.
- ✧ It is necessary to use M3 screw or installation bracket to fix the external keypad. The installation bracket for VFDs of 380 V 1.5–30 kW is optional but it is standard for the VFDs of 380 V 37–500 kW and the VFDs of 660 V.

No.	Name	Description	
1	State LED	RUN/TUNE	LED off means that the VFD is in the stopping state; LED blinking means the VFD is in the parameter autotune state; LED on means the VFD is in the running state.
		FWD/REV	FED/REV LED LED off means the VFD is in the forward rotation state; LED on means the VFD is in the reverse rotation state
		LOCAL/REMOT	LED for keypad operation, terminals operation and remote communication control LED off means that the VFD is in the keypad

No.	Name	Description					
		operation state; LED blinking means the VFD is in the terminals operation state; LED on means the VFD is in the remote communication control state.					
		TRIP	LED for faults LED on when the VFD is in the fault state; LED off in normal state; LED blinking means the VFD is in the pre-alarm state.				
2	Unit LED	Mean the unit displayed currently					
			Hz	Frequency unit			
			RPM	Rotating speed unit			
			A	Current unit			
			%	Percentage			
V	Voltage unit						
3	Code displaying zone	5-figure LED display displays various monitoring data and alarm code such as set frequency and output frequency.					
		Displayed word	Corresponding word	Displayed word	Corresponding word	Displayed word	Corresponding word
		0	0	1	1	2	2
		3	3	4	4	5	5
		6	6	7	7	8	8
		9	9	A.	A	b.	B
		C.	C	d	d	E.	E
		F.	F	H.	H	I.	I
		L.	L	n.	N	n	n
		O.	o	P.	P	r	r
S.	S	t	t	U.	U		
v.	v	.	.	-	-		
4	Digital potentiometer	Tuning frequency. Please refer to P08.42.					
5	Buttons		Programming key	Enter or escape from the first level menu and remove the parameter quickly			
			Entry key	Enter the menu step-by-step Confirm parameters			

No.	Name	Description	
		UP key	Increase data or function code progressively
		DOWN key	Decrease data or function code progressively
		Right-shift key	Move right to select the displaying parameter circularly in stopping and running mode. Select the parameter modifying digit during the parameter modification
		Run key	This key is used to operate on the VFD in key operation mode
		Stop/ Reset key	This key is used to stop in running state and it is limited by function code P07.04 This key is used to reset all control modes in the fault alarm state
		Quick key	The function of this key is confirmed by function code P07.02.

5.3 Keypad displaying

The keypad displaying state of Goodrive35 series VFDs is divided into stopping state parameter, running state parameter, function code parameter editing state and fault alarm state and so on.

5.3.1 Displayed state of stopping parameter

When the VFD is in the stopping state, the keypad will display stopping parameters which is shown in Figure 5-2.

In the stopping state, various kinds of parameters can be displayed. Select the parameters to be displayed or not by P07.07. See the instructions of P07.07 for the detailed definition of each bit.

In the stopping state, there are 14 stopping parameters can be selected to be displayed or not. They are: set frequency, bus voltage, input terminals state, output terminals state, PID given value, PID feedback value, torque set value, AI1, AI2, AI3, HDI, PLC and the current stage of multi-step speeds, pulse counting value, length value. P07.07 can select the parameter to be displayed or not by bit and  /SHIFT can shift the parameters form left to right, QUICK/JOG (P07.02=2) can shift the parameters form right to left.

5.3.2 Displayed state of running parameters

After the VFD receives valid running commands, the VFD will enter into the running state and the keypad will display the running parameters. RUN/TUNE LED on the keypad is on, while the FWD/REV is determined by the current running direction which is shown as Figure 5-2.

In the running state, there are 24 parameters that can be selected to be displayed or not. They are: running frequency, set frequency, bus voltage, output voltage, output torque, PID given value, PID feedback value, input terminals state, output terminals state, torque set value, length value, PLC and the current stage of multi-step speeds, pulse counting value, AI1, AI2, AI3, HDI, percentage of motor overload, percentage of VFD overload, ramp given value, linear speed, AC input current. P07.05 and P07.06 can select the parameter to be displayed or not by bit and **» /SHIFT** can shift the parameters from left to right, **QUICK/JOG** (P07.02=2) can shift the parameters from right to left.

5.3.3 Displayed state of fault

If the VFD detects the fault signal, it will enter into the fault pre-alarm displaying state. The keypad will display the fault code by flicking. The **TRIP** LED on the keypad is on, and the fault reset can be operated by the **STOP/RST** on the keypad, control terminals or communication commands.

5.3.4 Displayed state of function codes editing

In the state of stopping, running or fault, press **PRG/ESC** to enter into the editing state (if there is a password, see P07.00). The editing state is displayed on two classes of menu, and the order is: function code group/function code number → function code parameter, press **DATA/ENT** into the displayed state of function parameter. On this state, you can press **DATA/ENT** to save the parameters or press **PRG/ESC** to retreat.

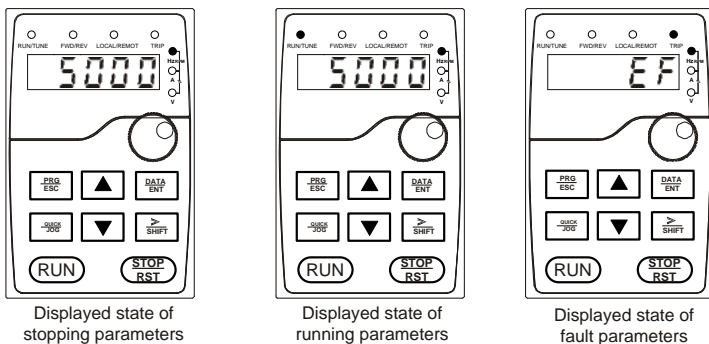

Figure 5-2 Displayed state

5.4 Keypad operation

Operate the VFD via operation panel. See the detailed structure description of function codes in the brief diagram of function codes.

5.4.1 How to modify the function codes of the VFD

The VFD has three levels menu, which are:

1. Group number of function code (first-level menu)
2. Tab of function code (second-level menu)

3. Set value of function code (third-level menu)

Remarks: Press both the **PRG/ESC** and the **DATA/ENT** can return to the second-level menu from the third-level menu. The difference is: pressing **DATA/ENT** will save the set parameters into the control panel, and then return to the second-level menu with shifting to the next function code automatically; while pressing **PRG/ESC** will directly return to the second-level menu without saving the parameters, and keep staying at the current function code.

Under the third-level menu, if the parameter has no flickering bit, it means the function code cannot be modified. The possible reasons could be:

- 1) This function code is not modifiable parameter, such as actual detected parameter, operation records and so on;
- 2) This function code is not modifiable in running state, but modifiable in stop state.

Example: Set function code P00.01 from 0 to 1.

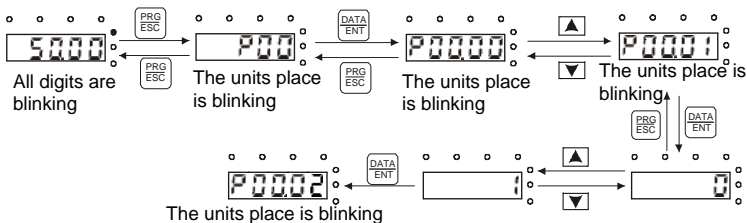

Note: When setting the value, you can press **SHIFT** and **↓** + **↑** to modify the value.

Figure 5-3 Sketch map of modifying parameters

5.4.2 How to set the password of the VFD

Goodrive35 series VFDs provide the user password protection function. When you set P07.00 to a non-zero value, the value is the user password. After you exit the function code editing interface, the password protection function is enabled within 1 minute. If password protection is enabled, "0.0.0.0.0" is displayed when you press the **PRG/ESC** key again to enter the function code editing interface. You need to enter the correct user password to enter the interface.

To disable the password protection function, you need only to set P07.00 to 0.

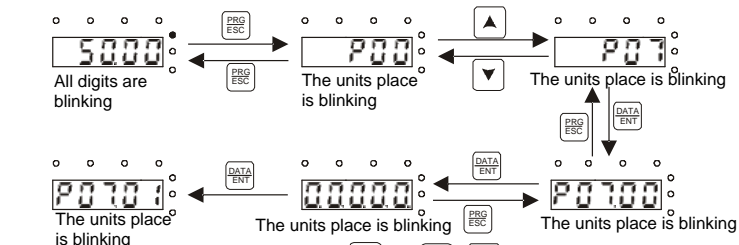

Note: When setting the value, you can press **SHIFT** and **↓** + **↑** to modify the value.

Figure 5-4 Sketch map of password setting

5.4.3 How to watch the VFD state through function codes

Goodrive35 series VFDs provide group P17 as the state inspection group. Users can enter into P17 directly to watch the state.

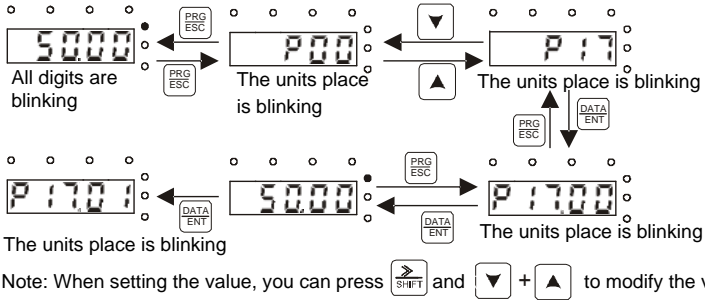

Figure 5-5 Sketch map of state watching

6 Function parameters

6.1 What this chapter contains

This chapter lists and describes the function parameters.

6.2 Goodrive35 general series function parameters

The function parameters of Goodrive35 series VFDs have been divided into 30 groups (P00–P29) according to the function, of which P18–P28 are reserved. Each function group contains certain function codes applying 3-level menus. For example, "P08.08" means the eighth function code in the P8 group function, P29 group is factory reserved, and users are forbidden to access these parameters.

For the convenience of function codes setting, the function group number corresponds to the first level menu, the function code corresponds to the second level menu and the function code corresponds to the third level menu.

1. Below is the instruction of the function lists:

The first line "Function code": codes of function parameter group and parameters;

The second line "Name": full name of function parameters;

The third line "Description ": detailed illustration of the function parameters

The fourth line "Default ": the original factory values of the function parameter;

The fifth line "Modify": the modifying character of function codes (the parameters can be modified or not and the modifying conditions), below is the instruction:

"○": means the set value of the parameter can be modified on stop and running state;

"◎": means the set value of the parameter cannot be modified on the running state;

"●": means the value of the parameter is the real detection value which cannot be modified.

(The VFD has limited the automatic inspection of the modifying character of the parameters to help users avoid mismodifying)

2. "Parameter radix" is decimal (DEC), if the parameter is expressed by hex, then the parameter is separated from each other when editing. The setting range of certain bits is 0–F (hex).

3. "The default value" means the function parameter will restore to the default value during default parameters restoring. But the detected parameter or recorded value won't be restored.

4. For a better parameter protection, the VFD provides password protection to the parameters. After setting the password (set P07.00 to any non-zero number), the system will come into the state of password verification firstly after the user press **PRG/ESC** to come into the function code editing state. And then "0.0.0.0.0." will be displayed. Unless the user input right password, they cannot enter into the system. For the factory setting parameter zone, it needs correct factory password (remind that the users cannot modify the factory parameters by themselves, otherwise, if the parameter setting is incorrect, damage to the VFD may occur). If the password protection is unlocked, the user can modify

the password freely and the VFD will work as the last setting one. When P07.00 is set to 0, the password can be canceled. If P07.00 is not 0 during powering on, then the parameter is protected by the password. When modify the parameters by serial communication, the function of the password follows the above rules, too.

P00 Group Basic functions

Function code	Name	Description	Default	Modify
P00.00	Speed control mode	<p>0: Sensorless vector control mode 0 (apply to AM and SM) No need to install encoders. It is suitable in cases with low frequency, big torque and high speed control accuracy for accurate speed and torque control. Relative to mode 1, this mode is more suitable for medium and small power.</p> <p>1: Sensorless vector control mode 1 (applying to AM) No need to install encoders. It is suitable in cases with high speed control accuracy for accurate speed and torque control at all power ratings.</p> <p>2: SVPWM control No need to install encoders. It can improve the control accuracy with the advantages of stable operation, valid low-frequency torque boost and current vibration suppression and the functions of slip compensation and voltage adjustment.</p> <p>3: Closed-loop vector control Need to install encoders. It is suitable in cases with low frequency, high speed control accuracy for accurate speed and torque control.</p> <p>Note: AM-Asynchronous Motor; SM-Synchronous Motor; motor parameter autotuning should be performed on the VFD before vector mode is adopted.</p>	2	⊙
P00.01	Run command channel	<p>Select the run command channel of the VFD. The control command of the VFD includes: start-up, stop, forward, reverse, jogging and fault reset.</p> <p>0: Keypad running command channel ("LOCAL/REMOT" light off)</p>	0	○

Function code	Name	Description	Default	Modify
		<p>Carry out the command control by RUN, STOP/RST on the keypad.</p> <p>Set the multi-function key QUICK/JOG to FWD/REV shifting function (P07.02=3) to change the running direction; press RUN and STOP/RST simultaneously in running state to make the VFD coast to stop.</p> <p>1: Terminal running command channel ("LOCAL/REMOTE" flickering)</p> <p>Carry out the running command control by the forward rotation, reverse rotation and forward jogging and reverse jogging of the multi-function terminals</p> <p>2: Communication running command channel ("LOCAL/REMOTE" on);</p> <p>The running command is controlled by the upper monitor via communication</p>		
P00.02	Communication running commands	<p>Select the controlling communication command channel of the VFD.</p> <p>0: Modbus communication channel 1: PROFIBUS/CANopen communication channel 2: Ethernet communication channel 3: Reserved</p> <p>Note: 1, 2 and 3 are expansion functions which need corresponding expansion cards.</p>	0	○
P00.03	Max. output frequency	<p>This parameter is used to set the maximum output frequency of the VFD. Users should pay attention to this parameter because it is the foundation of the frequency setting and the speed of acceleration and deceleration.</p> <p>Setting range: P00.04–400.00 Hz</p>	50.00 Hz	◎
P00.04	Upper limit of the running frequency	<p>The upper limit of the running frequency is the upper limit of the output frequency of the VFD which is lower than or equal to the maximum frequency.</p> <p>Setting range: P00.05–P00.03 (max. output frequency)</p>	50.00 Hz	◎

Function code	Name	Description	Default	Modify
P00.05	Lower limit of the running frequency	<p>The lower limit of the running frequency is that of the output frequency of the VFD.</p> <p>The VFD runs at the lower limit frequency if the set frequency is lower than the lower limit one.</p> <p>Note: Max. output frequency \geq Upper limit frequency \geq Lower limit frequency</p> <p>Setting range: 0.00 Hz–P00.04 (Upper limit of the running frequency)</p>	0.00 Hz	☉
P00.06	A frequency command	<p>Note: Frequency A and frequency B cannot use the same frequency setting mode. The frequency source can be set by P00.09.</p> <p>0: Keypad</p> <p>Modify the value P00.10 (set the frequency by keypad) to modify the frequency by the keypad.</p> <p>1: AI1</p> <p>2: AI2</p> <p>3: AI3</p> <p>Set the frequency by analog input terminals. Goodrive35 series VFDs provide 3 analog input terminals as the standard configuration, of which AI1/AI2 are the voltage/current option (0–10 V/0–20mA) which can be shifted by jumpers; while AI3 is voltage input (-10 V→+10 V).</p> <p>Note: When AI1/AI2 select 0–20mA input, the corresponding voltage of 20mA is 10 V.</p> <p>100.0% of the analog input setting corresponds to the maximum frequency (function code P00.03) in forward direction and -100.0% corresponds to the maximum frequency in reverse direction (function code P00.03)</p> <p>4: High-speed pulse HDI setting</p> <p>The frequency is set by high-speed pulse terminals. The VFDs provide 1 high speed pulse input as the standard configuration. The pulse frequency range is 0.000–50.000 kHz.</p> <p>100.0% of the high speed pulse input setting corresponds to the maximum frequency in forward direction (P00.03) and -100.0% corresponds to the</p>	0	○
P00.07	B frequency command	<p>0: Keypad</p> <p>Modify the value P00.10 (set the frequency by keypad) to modify the frequency by the keypad.</p> <p>1: AI1</p> <p>2: AI2</p> <p>3: AI3</p> <p>Set the frequency by analog input terminals. Goodrive35 series VFDs provide 3 analog input terminals as the standard configuration, of which AI1/AI2 are the voltage/current option (0–10 V/0–20mA) which can be shifted by jumpers; while AI3 is voltage input (-10 V→+10 V).</p> <p>Note: When AI1/AI2 select 0–20mA input, the corresponding voltage of 20mA is 10 V.</p> <p>100.0% of the analog input setting corresponds to the maximum frequency (function code P00.03) in forward direction and -100.0% corresponds to the maximum frequency in reverse direction (function code P00.03)</p> <p>4: High-speed pulse HDI setting</p> <p>The frequency is set by high-speed pulse terminals. The VFDs provide 1 high speed pulse input as the standard configuration. The pulse frequency range is 0.000–50.000 kHz.</p> <p>100.0% of the high speed pulse input setting corresponds to the maximum frequency in forward direction (P00.03) and -100.0% corresponds to the</p>	2	○

Function code	Name	Description	Default	Modify
		<p>maximum frequency in reverse direction (P00.03).</p> <p>Note: The pulse setting can only be input by multi-function terminals HDI. Set P05.00 (HDI input selection) to high speed pulse input, and set P05.49 (HDI high speed pulse input function selection) to frequency setting input.</p> <p>5: Simple PLC program setting The VFD runs at simple PLC program mode when P00.06=5 or P00.07=5. Set P10 (simple PLC and multi-step speed control) to select the running frequency, running direction, ACC/DEC time and the keeping time of corresponding stage. See the function description of P10 for detailed information.</p> <p>6: Multi-step speed running setting The VFD runs at multi-step speed mode when P00.06=6 or P00.07=6. Set P05 to select the current running stage, and set P10 to select the current running frequency. The multi-step speed has the priority when P00.06 or P00.07 does not equal to 6, but the setting stage can only be the 1–15 stage. The setting stage is 0–15 if P00.06 or P00.07 equals to 6.</p> <p>7: PID control setting The running mode of the VFD is process PID control when P00.06=7 or P00.07=7. It is necessary to set P09. The running frequency of the VFD is the value after PID effect. See P09 for the detailed information of the given source, given value, feedback source of PID.</p> <p>8: Modbus communication setting The frequency is set by Modbus communication. See P14 for detailed information.</p> <p>9: PROFIBUS/CANopen communication setting The frequency is set by PROFIBUS/ CANopen communication. See P15 for the detailed information.</p> <p>10: Ethernet communication setting (reserved)</p>		

Function code	Name	Description	Default	Modify
		See P16 for the detailed information. 11: Reserved 12: Pulse string AB setting		
P00.08	B frequency command reference	0: Maximum output frequency, 100% of B frequency setting corresponds to the maximum output frequency 1: A frequency command, 100% of B frequency setting corresponds to the maximum output frequency. Select this setting if it needs to adjust on the base of A frequency command	0	<input type="radio"/>
P00.09	Combination of setting source	0: A, the current frequency setting is A frequency command 1: B, the current frequency setting is B frequency command 2: A+B, the current frequency setting is A frequency command + B frequency command 3: A-B, the current frequency setting is A frequency command - B frequency command 4: Max (A, B): The bigger one between A frequency command and B frequency is the set frequency. 5: Min (A, B): The lower one between A frequency command and B frequency is the set frequency. Note: The combination manner can be shifted by P05 (terminal function)	0	<input type="radio"/>
P00.10	Keypad set frequency	When A and B frequency commands are selected as "keypad setting", the value of the function code is the original setting one of the frequency data of the VFD. Setting range: 0.00 Hz- P00.03 (max. output frequency)	50.00 Hz	<input type="radio"/>
P00.11	ACC time 1	ACC time means the time needed if the VFD speeds up from 0 Hz to max. output frequency (P00.03).	Depend on model	<input type="radio"/>
P00.12	DEC time 1	DEC time means the time needed if the VFD speeds down from max. output frequency to 0 Hz (P00.03). The VFDs define four groups of ACC/DEC time which can be selected by P05. The factory default ACC/DEC time of the VFD is the first group. Setting range of P00.11 and P00.12 : 0.0-3600.0s	Depend on model	<input type="radio"/>

Function code	Name	Description	Default	Modify																												
P00.13	Running direction	<p>0: Runs at the default direction, the VFD runs in the forward direction. FWD/REV indicator is off.</p> <p>1: Runs at the reverse direction, the VFD runs in the reverse direction. FWD/REV indicator is on.</p> <p>Modify the function code to shift the rotation direction of the motor. This effect equals to the shifting the rotation direction by adjusting either two of the motor lines (U, V and W). The motor rotation direction can be changed by QUICK/JOG on the keypad. Refer to parameter P07.02.</p> <p>Note: When the function parameter comes back to the default value, the motor's running direction will come back to the factory default state, too. In some cases it should be used with caution after commissioning if the change of rotation direction is disabled.</p> <p>2: Forbid to run in reverse direction: It can be used in some special cases if reverse running is disabled.</p>	0	<input type="radio"/>																												
P00.14	Carrier frequency setting	<table border="1" style="width: 100%; text-align: center;"> <thead> <tr> <th>Carrier frequency</th> <th>Electro magnetic noise</th> <th>Noise and leakage current</th> <th>Cooling level</th> </tr> </thead> <tbody> <tr> <td>1kHz</td> <td rowspan="3">↑ High</td> <td rowspan="3">↑ Low</td> <td rowspan="3">↑ Low</td> </tr> <tr> <td>10kHz</td> </tr> <tr> <td>15kHz</td> <td>↓ Low</td> <td>↓ High</td> <td>↓ High</td> </tr> </tbody> </table> <p>The relationship table of the motor type and carrier frequency:</p> <table border="1" style="width: 100%; text-align: center;"> <thead> <tr> <th colspan="2">Model</th> <th>The factory value of carrier frequency</th> </tr> </thead> <tbody> <tr> <td rowspan="3">380 V</td> <td>1.5–11 kW</td> <td>8 kHz</td> </tr> <tr> <td>15–55 kW</td> <td>4 kHz</td> </tr> <tr> <td>Above 75 kW</td> <td>2 kHz</td> </tr> <tr> <td rowspan="2">660 V</td> <td>22–55 kW</td> <td>4 kHz</td> </tr> <tr> <td>Above 75 kW</td> <td>2 kHz</td> </tr> </tbody> </table>	Carrier frequency	Electro magnetic noise	Noise and leakage current	Cooling level	1kHz	↑ High	↑ Low	↑ Low	10kHz	15kHz	↓ Low	↓ High	↓ High	Model		The factory value of carrier frequency	380 V	1.5–11 kW	8 kHz	15–55 kW	4 kHz	Above 75 kW	2 kHz	660 V	22–55 kW	4 kHz	Above 75 kW	2 kHz	Depend on model	<input type="radio"/>
Carrier frequency	Electro magnetic noise	Noise and leakage current	Cooling level																													
1kHz	↑ High	↑ Low	↑ Low																													
10kHz																																
15kHz				↓ Low	↓ High	↓ High																										
Model		The factory value of carrier frequency																														
380 V	1.5–11 kW	8 kHz																														
	15–55 kW	4 kHz																														
	Above 75 kW	2 kHz																														
660 V	22–55 kW	4 kHz																														
	Above 75 kW	2 kHz																														

Function code	Name	Description	Default	Modify
		<p>The advantage of high carrier frequency: ideal current waveform, little current harmonic wave and motor noise.</p> <p>The disadvantage of high carrier frequency: increasing the switch loss, increasing VFD temperature and the impact to the output capacity. The VFD needs to derate on high carrier frequency. At the same time, the leakage and electrical magnetic interference will increase.</p> <p>Applying low carrier frequency is contrary to the above, too low carrier frequency will cause unstable running, torque decreasing and surge.</p> <p>The manufacturer has set a reasonable carrier frequency when the VFD is in factory. In general, users do not need to change the parameter.</p> <p>When the frequency used exceeds the default carrier frequency, the VFD needs to derate 10% for each additional 1k carrier frequency.</p> <p>Setting range: 1.2–15.0 kHz</p>		
P00.15	Motor parameter autotuning	<p>0: No operation</p> <p>1: Rotation autotuning</p> <p>Comprehensive motor parameter autotune</p> <p>It is recommended to use rotation autotuning when high control accuracy is needed.</p> <p>2: Static autotuning 1 (autotune totally); It is suitable in the cases when the motor cannot de-couple from the load. The autotuning for the motor parameter will impact the control accuracy.</p> <p>3: Static autotuning 2 (autotune part parameters); when the current motor is motor 1, autotune P02.06, P02.07, P02.08; and when the current motor is motor 2, autotune P12.06, P12.07, P12.08.</p>	0	⊙
P00.16	AVR function selection	<p>0: Invalid</p> <p>1: Valid during the whole procedure</p> <p>The auto-adjusting function of the VFD can cancel the impact on the output voltage of the VFD because of the bus voltage fluctuation.</p>	1	○

Function code	Name	Description	Default	Modify
P00.17	Reserved	Reserved	0	☉
P00.18	Function restore parameter	<p>0: No operation 1: Restore the default value 2: Cancel the fault record</p> <p>Note: The function code will restore to 0 after finishing the operation of the selected function code. Restoring to the default value will cancel the user password, please use this function with caution.</p>	0	☉

P01 Group Start and stop control

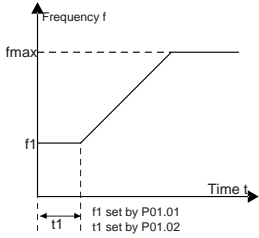
Function code	Name	Description	Default	Modify
P01.00	Start mode	<p>0: Start-up directly: start from the starting frequency P01.01 1: Start-up after DC braking: start the motor from the starting frequency after DC braking (set the parameter P01.03 and P01.04). It is suitable in the cases where reverse rotation may occur to the low inertia load during starting. 2: Start-up after speed tracing: start the rotating motor smoothly after tracking the rotation speed and direction automatically. It is suitable in the cases where reverse rotation may occur to the big inertia load during starting.</p> <p>Note: The VFDs above 4 kW have the function.</p>	0	☉
P01.01	Starting frequency of direct start	<p>Starting frequency of direct start-up means the original frequency during the VFD starting. See P01.02 for detailed information. Setting range: 0.00–50.00 Hz</p>	0.00 Hz	☉
P01.02	Retention time of starting frequency		0.0 s	☉

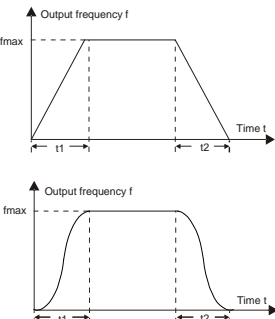
Function code	Name	Description	Default	Modify
		Set a proper starting frequency to increase the torque of the VFD during starting. During the retention time of the starting frequency, the output frequency of the VFD is the starting frequency. And then, the VFD will run from the starting frequency to the set frequency. If the set frequency is lower than the starting frequency, the VFD will stop running and keep in the stand-by state. The starting frequency is not limited in the lower limit frequency. Setting range: 0.0–50.0s		
P01.03	The brake current before starting	The VFD will carry out DC braking at the braking current set before starting and it will speed up after the DC braking time. If the DC braking time is set to 0, the DC braking is invalid.	0.0%	⊙
P01.04	The braking time before starting	The stronger the braking current, the bigger the braking power. The DC braking current before starting means the percentage of the rated output current of the VFD. Setting range of P01.03 : 0.0–100.0% Setting range of P01.04 : 0.0–30.0s	0.0 s	⊙
P01.05	ACC/DEC selection	The changing mode of the frequency during start-up and running. 0: Linear type. The output frequency increases or decreases linearly. 1: S curve. The output frequency increases or decreases according to the S curve. S curve is generally used in cases where smooth startup/stop is required eg elevator, conveyor belt, etc. 	0	⊙

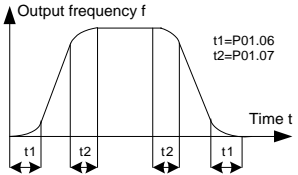
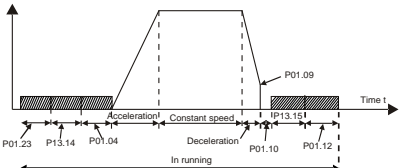
Function code	Name	Description	Default	Modify
P01.06	ACC time of the starting step of S curve	The curve rate of S curve is determined by the acceleration range and acceleration/deceleration time. 	0.1 s	☉
P01.07	DEC time of the ending step of S curve		0.1 s	☉
P01.08	Stop mode	0: Decelerate to stop: after the stop command becomes valid, the VFD decelerates to decrease the output frequency during the set time. When the frequency decreases to P01.15 , the VFD stops. 1: Coast to stop: after the stop command becomes valid, the VFD ceases the output immediately. And the load coasts to stop at the mechanical inertia.	0	○
P01.09	Starting frequency of DC braking	The starting frequency of stop braking: The VFD will carry on stop DC braking when the frequency is arrived during the procedure of decelerating to stop. Demagnetizing time: Before the stop DC braking, the VFD will close output and begin to carry on the DC braking after the waiting time. This function is used to avoid the overcurrent fault caused by DC braking when the speed is too high. Stop DC braking current: the DC braking added. The stronger the current, the bigger the DC braking effect. The braking time of stop braking: the retention time of DC braking. If the time is 0, the DC braking is invalid. The VFD will stop at the set deceleration time.	0.00 Hz	○
P01.10	Demagnetizing time		0.00 s	○
P01.11	DC braking current		0.0%	○
P01.12	DC braking time		0.0 s	○

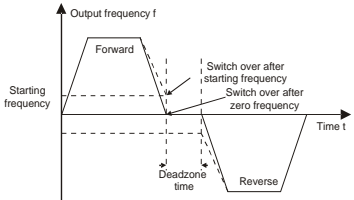
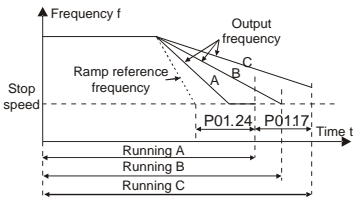
Function code	Name	Description	Default	Modify
		Setting range of P01.09 : 0.00 Hz– P00.03 (max. output frequency) Setting range of P01.10 : 0.00–30.00s Setting range of P01.11 : 0.0–100.0% (corresponding to the rated output current of the VFD) Setting range of P01.12 : 0.0–50.0s		
P01.13	Dead time of FWD/REV rotation	During the procedure of switching for/rev rotation, set the threshold by P01.14 , which is as the table below:  Setting range: 0.0–3600.0s	0.0 s	○
P01.14	Shifting between FWD/REV rotation	Set the threshold point of the VFD: 0: Switch after zero frequency 1: Switch after the starting frequency	0	◎
P01.15	Stopping speed	0.00–100.00 Hz	0.20 Hz	◎
P01.16	Detection of stopping speed	0: Detect according to speed setting (no stopping delay) 1: Detect according to speed feedback (only valid for vector control)	0	◎
P01.17	Detection time of the feedback speed	If set P01.16 to 1, the feedback frequency is less than or equal to P01.15 and detect in the set time of P01.17 , the VFD will stop; otherwise the VFD will stop after the set time of P01.17 . 	0.5 s	◎

Function code	Name	Description	Default	Modify
		Setting range: 0.0–100.0s (only valid when P01.16=1)		
P01.18	Terminal running protection when powering on	<p>When the running commands are controlled by the terminal, the system will detect the state of the running terminal during powering on.</p> <p>0: The terminal running command is invalid when powering on. Even the running command is detected to be valid during powering on, the VFD won't run and the system keeps in the protection state until the running command is canceled and enabled again.</p> <p>1: The terminal running command is valid when powering on. If the running command is detected to be valid during powering on, the system will start the VFD automatically after the initialization.</p> <p>Note: this function should be selected with cautions, or serious result may follow.</p>	0	○
P01.19	Action if running frequency < lower limit frequency (valid >0)	<p>This function code determines the running state of the VFD when the set frequency is lower than the lower-limit one.</p> <p>0: Run at the lower-limit frequency 1: Stop 2: Hibernation 3: Run at zero frequency</p> <p>The VFD will coast to stop when the set frequency is lower than the lower-limit one. If the set frequency is above the lower limit one again and it lasts for the time set by P01.20, the VFD will come back to the running state automatically.</p>	0	◎
P01.20	Hibernation restore delay time	<p>This function code determines the hibernation delay time. When the running frequency of the VFD is lower than the lower limit one, the VFD will pause to stand by.</p> <p>When the set frequency is above the lower limit one again and it lasts for the time set by P01.20, the VFD will run automatically.</p>	0.0 s	○

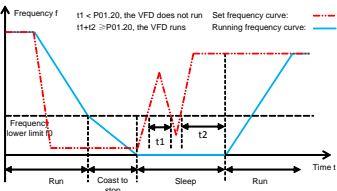
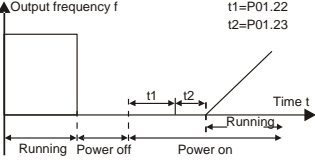
Function code	Name	Description	Default	Modify
		 <p>Setting range: 0.0–3600.0s (valid when P01.19=2)</p>		
P01.21	Restart after power off	<p>This function can enable the VFD start or not after the power off and then power on.</p> <p>0: Disable 1: Enable, if the starting need is met, the VFD will run automatically after waiting for the time defined by P01.22.</p>	0	<input type="radio"/>
P01.22	The waiting time of restart after power off	<p>The function determines the waiting time before the automatic running of the VFD when powering off and then powering on.</p>  <p>Setting range: 0.0–3600.0 s (valid when P01.21=1)</p>	1.0 s	<input type="radio"/>
P01.23	Start delay time	<p>The function determines the braking release after the running command is given, and the VFD is in a stand-by state and wait for the delay time set by P01.23.</p> <p>Setting range: 0.00–60.00 s</p>	0.00 s	<input type="radio"/>
P01.24	Delay time of the stop speed	<p>Setting range: 0.0–60.0 s</p>	0.0 s	<input type="radio"/>
P01.25	DEC time of E-stop	<p>DEC time of E-stop (terminal function is set to 56).</p> <p>Setting range: 0.00–60.00 s</p>	2.00 s	<input type="radio"/>

P02 Group Motor 1 parameters

Function code	Name	Description	Default	Modify
P02.00	Motor type 1	0: AM 1: SM Note: Switch the current motor by the switching channel of P08.31 .	0	☉
P02.01	Rated power of AM 1	0.1–3000.0 kW	Depend on model	☉
P02.02	Rated frequency of AM 1	0.01 Hz– P00.03 (max. output frequency)	50.00 Hz	☉
P02.03	Rated speed of AM 1	1–36000rpm	Depend on model	☉
P02.04	Rated voltage of AM 1	0–1200 V	Depend on model	☉
P02.05	Rated current of AM 1	0.8–6000.0A	Depend on model	☉
P02.06	Stator resistor of AM 1	0.001–65.535Ω	Depend on model	○
P02.07	Rotor resistor of AM 1	0.001–65.535Ω	Depend on model	○

Function code	Name	Description		Default	Modify	
P02.08	Leakage inductance of AM 1	0.1–6553.5mH	basic parameters for high-performance vector control, which will impact the control performance directly. Note: Users cannot change this group of parameters at will.	Depend on model	<input type="radio"/>	
P02.09	Mutual inductance of AM 1	0.1–6553.5mH		Depend on model	<input type="radio"/>	
P02.10	Non-load current of AM 1	0.1–6553.5A		Depend on model	<input type="radio"/>	
P02.11	Magnetic saturation coefficient 1 for iron core of AM1	0.0–100.0%		80.0%	<input checked="" type="radio"/>	
P02.12	Magnetic saturation coefficient 2 for iron core of AM1	0.0–100.0%		68.0%	<input checked="" type="radio"/>	
P02.13	Magnetic saturation coefficient 3 for iron core of AM1	0.0–100.0%		55.0%	<input checked="" type="radio"/>	
P02.14	Magnetic saturation coefficient 4 for iron core of AM1	0.0–100.0%		40.0%	<input checked="" type="radio"/>	
P02.15	Rated power of SM 1	0.1–3000.0 kW	Set the parameters of controlled SM. In order to ensure control performance, set the value of P02.15–P02.19 based on the nameplate parameters of the motor.	Depend on model	<input checked="" type="radio"/>	
P02.16	Rated frequency of SM 1	0.01 Hz– P00.03 (max. output frequency)		50.00 Hz	<input checked="" type="radio"/>	
P02.17	Number of poles pairs for SM 1	1–128		2	<input checked="" type="radio"/>	
P02.18	Rated voltage of SM 1	0–1200 V		Goodrive35 series VFD provides parameter autotuning function. The accurate parameter autotuning requires proper parameter setup.	Depend on model	<input checked="" type="radio"/>
P02.19	Rated current of SM 1	0.8–6000.0 A			Depend on	<input checked="" type="radio"/>

Function code	Name	Description		Default	Modify
			In order to ensure control performance, configure the motor based on the motor which matches with the VFD. If the gap between motor power and the matching motor is too large, the control performance of the VFD will be deteriorated greatly. Note: P02.16–P02.19 can be initialized by resetting rated motor power P02.15 .	model	
P02.20	Stator resistor of SM 1	0.001–65.535 Ω	After motor parameter autotuning finishes, the set value of P02.20–P02.22 will be updated automatically. These parameters are the basic parameters for high performance vector control, which will impact	Depend on model	<input type="radio"/>
P02.21	Direct axis inductance of SM 1	0.01–6553.5 mH		Depend on model	<input type="radio"/>
P02.22	Quadrature axis inductance of SM 1	0.01–655.35 mH		Depend on model	<input type="radio"/>
P02.23	Back EMF constant of SM 1	When P00.15 =2, the set value of P02.23 cannot be updated by autotuning, please count according to the following method. The counter-electromotive force constant can be counted according to the parameters on the nameplate of the motor. There are three ways to count:	the control performance directly. When P00.15 =1 (rotary autotuning), the set value of P02.23 can be updated automatically via autotuning; when P00.15 =2 (static autotuning), the set value of P02.23 cannot be updated via autotuning, calculate the value of P02.23 and update it	320	<input type="radio"/>

Function code	Name	Description	Default	Modify
		<p>1. If the name plate designate the counter-electromotive force constant K_e, then: $E = (K_e * n_N * 2\pi) / 60$</p> <p>2. If the name plate designate the counter-electromotive force constant E' (V/1000r/min), then: $E = E' * n_N / 1000$</p> <p>3. If the name plate does not designate the above parameters, then: $E = P / \sqrt{3} * I$</p> <p>In the above formulas: n_N is the rated rotation speed, P is the rated power and I is the rated current. Setting range: 0–10000</p>		
P02.24	Reserved			
P02.25	Reserved			
P02.26	Motor 1 overload protection	<p>0: No protection</p> <p>1: Common motor (with low speed compensation). Because the heat-releasing effect of the common motors will be weakened, the corresponding electric heat protection will be adjusted properly. The low speed compensation characteristic mentioned here means reducing the threshold of the overload protection of the motor whose running frequency is below 30 Hz.</p> <p>2: Variable frequency motor (without low speed compensation) Because the heat-releasing effect of the specific motors won't be impacted by the rotation speed, it is not necessary to adjust the protection value during low-speed running.</p>	2	⊙

Function code	Name	Description	Default	Modify
P02.27	Motor 1 overload protection coefficient	<p>Motor overload multiple $M = I_{out} / (I_n \times K)$</p> <p>$I_n$ is the rated current of the motor, I_{out} is the output current of the VFD and K is the motor overload protection coefficient.</p> <p>The smaller K is, the greater M is, and the more likely protection is implemented.</p> <p>When $M=116\%$, protection is performed after motor overload lasts for 1 hour; when $M=150\%$, protection is performed after motor overload lasts for 12 minutes; when $M=180\%$, protection is performed after motor overload lasts for 5 minutes; when $M=200\%$, protection is performed after motor overload lasts for 60 seconds; and when $M \geq 400\%$, protection is performed immediately.</p> <p>Setting range: 20.0%–120.0%</p>	100.0 %	<input type="radio"/>
P02.28	Motor 1 power display correction coefficient	<p>This function code is used to adjust the power display value of motor 1 only.</p> <p>Setting range: 0.00–3.00</p>	1.00	<input type="radio"/>
P02.29	Parameter display of motor 1	<p>0: Display according to the motor type</p> <p>1: Display all</p>	0	<input type="radio"/>

P03 Group Vector control

Function code	Name	Description	Default	Modify
P03.00	ASR proportional gain1	<p>The parameters of P03.00–P03.05 are applicable only to the vector control mode. When the frequency is lower than P03.02 (Low-point frequency for switching), the ASR PI parameters</p>	20.0	<input type="radio"/>
P03.01	ASR integral time1		0.200 s	<input type="radio"/>

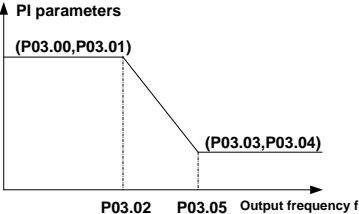
Function code	Name	Description	Default	Modify
P03.02	Low-point frequency for switching	are P03.00 and P03.01 . When the frequency is higher than P03.05 (High-point frequency for switching), the ASR PI parameters are P03.03 and	5.00 Hz	<input type="radio"/>
P03.03	ASR proportional gain 2	P03.04 . When the frequency is between P03.02 and P03.05 , the PI parameters are obtained based	20.0	<input type="radio"/>
P03.04	ASR integral time 2	on the linear change of these two groups of parameters, as shown in the following figure.	0.200 s	<input type="radio"/>
P03.05	High-point frequency for switching	 <p>You can adjust the dynamic response characteristics of the automatic speed regulator (ASR) in vector control by setting the ASR proportional gain and integral time. Both increasing the proportional gain and decreasing the integral time can accelerate the dynamic response of the ASR. However, if the proportional gain is too large or the integral time is too short, system oscillation or overadjustment may be caused. If the proportional gain is too small, system steady-state oscillation may be easily caused, and static speed error may also occur.</p> <p>The ASR PI parameters are closely related to the inertia of the system. The default PI parameters need to be modified based on the characteristics of loads to meet requirements of various scenarios.</p> <p>Setting range of P03.00: 0.0–200.0 Setting range of P03.01: 0.000–10.000s Setting range of P03.02: 0.00 Hz–P03.05 Setting range of P03.03: 0.0–200.0 Setting range of P03.04: 0.000–10.000s Setting range of P03.05: P03.02–P00.03 (max. output frequency)</p>	10.00 Hz	<input type="radio"/>

Function code	Name	Description	Default	Modify
P03.06	ASR output filter	0–8 (corresponds to 0–2 ³ /10 ms)	0	○
P03.07	Compensation coefficient of electromotion slip	Slip compensation coefficient is used to adjust the slip frequency of the vector control and improve the speed control accuracy of the system. Adjusting the parameter properly can control the speed steady-state error.	100%	○
P03.08	Compensation coefficient of braking slip	Setting range: 50%–200%	100%	○
P03.09	ACR proportional coefficient P	<p>Note:</p> <p>1. These two parameters adjust the PI adjustment parameter of the automatic current regulator (ACR). They directly affect the dynamic responding speed and control accuracy of the system. In general, you do not need to modify their default values.</p> <p>2. Applied to SVC 0 (P00.00=0) and closed-loop vector control mode only (P00.00=3)</p> <p>3. The value of this function code will be updated automatically after parameter autotuning of synchronous motor.</p> <p>Setting range: 0–20000</p>	1000	○
P03.10	ACR integral coefficient I		1000	○
P03.11	Torque setting method	<p>This parameter is used to enable the torque control mode, and set the torque.</p> <p>0: Torque control is invalid</p> <p>1: Keypad setting torque (P03.12)</p> <p>2: Analog AI1 setting torque</p> <p>3: Analog AI2 setting torque</p> <p>4: Analog AI3 setting torque</p> <p>5: Pulse frequency HDI setting torque</p> <p>6: Multi-step torque setting</p> <p>7: Modbus communication setting torque</p> <p>8: PROFIBUS/CANopen communication setting torque</p> <p>9: Ethernet communication setting torque</p> <p>10: Reserved</p> <p>Note: Setting modes 2–10, 100% corresponds to three times of the rated current of the motor.</p>	0	○

Function code	Name	Description	Default	Modify
P03.12	Keypad setting torque	Setting range: -300.0%–300.0% (rated current of the motor)	10.0%	<input type="radio"/>
P03.13	Torque reference filter time	0.000–10.000s	0.100 s	<input type="radio"/>
P03.14	Upper frequency of forward rotation in vector control	0: Keypad (P03.16 sets P03.14 , P03.17 sets P03.15) 1: AI1 2: AI2 3: AI3 4: Pulse frequency HDI setting upper-limit frequency 5: Multi-step setting upper-limit frequency 6: Modbus communication setting upper-limit frequency 7: PROFIBUS/CANopen communication setting upper-limit frequency 8: Ethernet communication setting upper-limit frequency Note: Setting method 0–8, 100% corresponds to the maximum frequency	0	<input type="radio"/>
P03.15	Upper frequency of reverse rotation in vector control	0: Keypad (P03.16 sets P03.14 , P03.17 sets P03.15) 1: AI1 2: AI2 3: AI3 4: Pulse frequency HDI setting upper-limit frequency 5: Multi-step setting upper-limit frequency 6: Modbus communication setting upper-limit frequency 7: PROFIBUS/CANopen communication setting upper-limit frequency 8: Ethernet communication setting upper-limit frequency Note: Setting method 0–8, 100% corresponds to the maximum frequency	0	<input type="radio"/>
P03.16	Keypad setting for upper frequency of forward rotation	This function is used to set the upper limit of the frequency. P03.16 determines the setting when P03.14 =1; P03.17 determines the setting when P03.15 =1.	50.00 Hz	<input type="radio"/>
P03.17	Keypad setting for upper frequency of reverse rotation	Setting range: 0.00 Hz– P00.03 (max. output frequency)	50.00 Hz	<input type="radio"/>
P03.18	Upper electromotion torque source	This function code is used to select the electromotion and braking torque upper-limit setting source selection.	0	<input type="radio"/>
P03.19	Upper braking torque source	0: Keypad setting upper-limit frequency (P03.20 sets P03.18 , P03.21 sets P03.19) 1: AI1 2: AI2 3: AI3 4: HDI 5: Modbus communication 6: PROFIBUS/CANopen communication 7: Ethernet communication	0	<input type="radio"/>

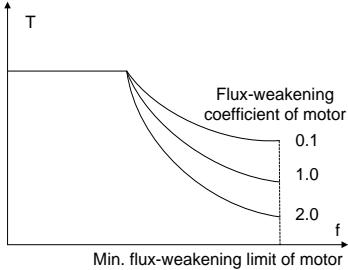
Function code	Name	Description	Default	Modify
		Note: setting mode 1–7,100% corresponds to three times of the motor current.		
P03.20	Keypad setting of electromotion torque	The function code is used to set the limit of the torque.	180.0 %	<input type="radio"/>
P03.21	Keypad setting of braking torque	Setting range: 0.0–300.0% (motor rated current)	180.0 %	<input type="radio"/>
P03.22	Weakening coefficient in constant power zone	The usage of AM in weakening control. 	1.00	<input type="radio"/>
P03.23	Lowest weakening point in constant power zone	Function code P03.22 and P03.23 are effective at constant power. The motor will enter into the weakening state when the motor runs at rated speed. Change the weakening curve by modifying the weakening control coefficient. The bigger the weakening control coefficient is, the steeper the weak curve is. Setting range of P03.22 : 0.10–2.00 Setting range of P03.23 : 5%–50%	20%	<input type="radio"/>
P03.24	Max voltage limit	P03.24 set the max voltage of the VFD, which is dependent on the site situation. The setting range: 0.0–120.0%	100.0 %	<input checked="" type="radio"/>
P03.25	Pre-exciting time	Preactivate the motor when the VFD starts up. Build up a magnetic field inside the VFD to improve the torque performance during the starting process. The setting time: 0.000–10.000s	0.000 s	<input type="radio"/>
P03.26	Weak proportional gain	The response characteristic of the flux weakening controller is relative to P03.26 and P03.27 . It can	1200	<input type="radio"/>
P03.27	Integral gain of the flux weakening	be adjusted properly. Setting range: 0–8000	1200	<input type="radio"/>

Function code	Name	Description	Default	Modify
P03.28	Control mode of flux weakening	0x000–0x112 Ones: Control mode selection 0: Mode 0; 1: Mode 1; 2: Mode 2 Tens: Inductance compensation selection 0: Compensate 1: Not compensate Hundreds: High-speed control mode 0: Mode 0 1: Mode 1	0x000	<input type="radio"/>
P03.29	Torque control mode	0x0000–0x7111 Ones: Torque command selection 0: Torque reference 1: Torque current reference Tens: Torque compensation direction at 0 speed 0: Positive 1: Negative Hundreds: ASR integral separation setting 0: Disabled 1: Enabled Thousands: Torque control word setting Bit0: Torque command filtering mode 0: Inertia filter 1: Linear ACC/DEC filtering Bit1–2: ACC/DEC time for rotating speed upper limit 0: No ACC/DEC time 1: ACC/DEC time 1 2: ACC/DEC time 2 3: ACC/DEC time 3	0x0001	<input type="radio"/>
P03.30	Low-speed friction torque	P03.30 is the compensation value of low-speed (<1.0 Hz) friction torque.	0.0%	<input type="radio"/>
P03.31	High-speed friction torque	P03.31 is the compensation value of high-speed (> P03.32) friction torque. The friction torque between low and high speed is the liner scale of	0.0%	<input type="radio"/>
P03.32	Corresponding frequency of	P03.30 and P03.31 . Note: Torque compensation is valid only in the	50.00 Hz	<input type="radio"/>

Function code	Name	Description	Default	Modify
	high-speed friction torque	torque control mode (P03.11 ≠0). Setting range of P03.30 : 0.0–50.0% (rated torque of the motor) Setting range of P03.31 : 0.0–50.0% (rated torque of the motor) Setting range of P03.32 : 1.00 Hz–400.00 Hz		

P04 Group SVPWM control

Function code	Name	Description	Default	Modify
P04.00	Motor 1 V/F curve setting	<p>These function codes define the V/F curve of Goodrive35 motor 1 to meet the need of different loads.</p> <p>0: Straight line V/F curve; applying to the constant torque load</p> <p>1: Multi-dots V/F curve</p> <p>2: Torque step-down V/F curve (power of 1.3)</p> <p>3: Torque step-down V/F curve (power of 1.7)</p> <p>4: Torque step-down V/F curve (power of 2.0)</p> <p>Curves 2–4 apply to the torque loads such as fans and water pumps. Users can adjust according to the features of the loads to achieve a best energy-consuming effect.</p> <p>5: Customized V/F (V/F separation); on this mode, V and F can be separated from f and f can be adjusted through the frequency given channel set by P00.06 or the voltage given channel set by P04.27 to change the feature of the curve.</p> <p>Note: V_b in the below picture is the motor rated voltage and f_b is the motor rated frequency.</p>	0	⊙
P04.01	Torque boost of motor 1	Torque boost to the output voltage for the features of low frequency torque. P04.01 is for the Max	0.0%	○
P04.02	Torque boost	Output voltage V_b .	20.0%	○

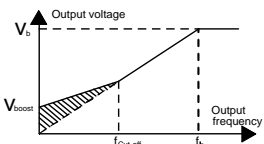
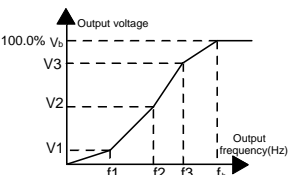
Function code	Name	Description	Default	Modify
	close of motor 1	<p>P04.02 defines the percentage of closing frequency of manual torque to f_b.</p> <p>Torque boost should be selected according to the load. The bigger the load is, the bigger the boost is. Too big torque boost is inappropriate because the motor will run with over-magnetic, and the current of the VFD will increase to raise the temperature of the VFD and decrease the efficiency.</p> <p>When the torque boost is set to 0.0%, the VFD is automatic torque boost.</p> <p>Torque boost threshold: under the threshold, the torque boost is valid, but over the threshold, the torque boost is invalid.</p>  <p>Setting range of P04.01: 0.0%: (automatic) 0.1%–10.0% Setting range of P04.02: 0.0%–50.0%</p>		
P04.03	V/F frequency 1 of motor 1	<p>When P04.00 =1, the user can set V//F curve through P04.03–P04.08.</p> <p>V/F is generally set according to the load of the motor.</p> <p>Note: $V1 < V2 < V3, f1 < f2 < f3$. Too high low frequency voltage will heat the motor excessively or cause damage. The VFD may stall when overcurrent or overcurrent protection.</p>  <p>Setting range of P04.03: 0.00 Hz–P04.05 Setting range of P04.04: 0.0%–110.0%</p>	0.00 Hz	<input type="radio"/>
P04.04	V/F voltage 1 of motor 1		0.0%	<input type="radio"/>
P04.05	V/F frequency 2 of motor 1		0.00 Hz	<input type="radio"/>
P04.06	V/F voltage 2 of motor 1		0.0%	<input type="radio"/>
P04.07	V/F frequency 3 of motor 1		0.00 Hz	<input type="radio"/>
P04.08	V/F voltage 3 of motor 1		0.0%	<input type="radio"/>

Function code	Name	Description	Default	Modify
		Setting range of P04.05 : P04.03 – P04.07 Setting range of P04.06 : 0.0%–110.0% (the rated voltage of motor 1) Setting range of P04.07 : P04.05 – P02.02 (the rated frequency of motor 1) or P04.05 – P02.16 (the rated frequency of motor 1) Setting range of P04.08 : 0.0%–110.0% (the rated voltage of motor 1)		
P04.09	V/F slip compensation gain of motor 1	This function code is used to compensate the change of the rotation speed caused by load during compensation SVPWM control to improve the rigidity of the motor. It can be set to the rated slip frequency of the motor which is counted as below: $\Delta f = f_b - n \cdot p / 60$ Of which, f_b is the rated frequency of the motor, its function code is P02.02 ; n is the rated rotating speed of the motor and its function code is P02.03 ; p is the pole pair of the motor. 100.0% corresponds to the rated slip frequency Δf . Setting range: 0.0–200.0%	100.0 %	○
P04.10	Vibration control factor at low frequency of motor 1	In SVPWM control mode, current fluctuation may occur to the motor at some frequency, especially the motor with big power. The motor cannot run stably or overcurrent may occur. These phenomena can be canceled by adjusting this parameter. Setting range of P04.10 : 0–100 Setting range of P04.11 : 0–100 Setting range of P04.12 : 0.00 Hz– P00.03 (max. output frequency)	10	○
P04.11	Vibration control factor at high frequency of motor 1		10	○
P04.12	Vibration control threshold of motor 1		30.00 Hz	○
P04.13	Motor 2 V/F curve	This group of parameters defines the V/F setting means of Goodrive35 motor 2 to meet various requirements of different loads. See P04.00 – P04.12 for the detailed function code instruction. Note: P04 group includes two sets of V/F	0	⊙
P04.14	Torque boost of motor 2		0.0%	○
P04.15	Torque boost close of motor 2		20.0%	○
P04.16	V/F frequency 1 of		0.00	○

Function code	Name	Description	Default	Modify
	motor 2	parameters of the motor which cannot display simultaneously. Only the selected V/F parameter can be shown. The motor selection can be defined by terminals function "the shift between motor 1 and motor 2"	Hz	
P04.17	V/F voltage 1 of motor 2		0.0%	<input type="radio"/>
P04.18	V/F frequency 2 of motor 2		0.00 Hz	<input type="radio"/>
P04.19	V/F voltage 2 of motor 2		0.0%	<input type="radio"/>
P04.20	V/F frequency 3 of motor 2		0.00 Hz	<input type="radio"/>
P04.21	V/F voltage 3 of motor 2		0.0%	<input type="radio"/>
P04.22	V/F slip compensation gain of motor 2		100.0 %	<input type="radio"/>
P04.23	Vibration control factor at low frequency of motor 2		In SVPWM control mode, current fluctuation may occur to the motor on some frequency, especially the motor with big power. The motor cannot run stably or overcurrent may occur. These phenomena can be canceled by adjusting this parameter. Setting range of P04.23 : 0–100	10
P04.24	Vibration control factor at high frequency of motor 2	Setting range of P04.24 : 0–100	10	<input type="radio"/>
P04.25	Vibration control threshold of motor 2	Setting range of P04.25 : 0.00 Hz– P00.03 (max. output frequency)	30.00 Hz	<input type="radio"/>
P04.26	Energy-saving operation	0: No operation 1: Automatic energy-saving operation (reserved) Motors will automatically adjust the output voltage to save energy when light loads.	0	<input checked="" type="radio"/>
P04.27	Voltage setting	Select the output setting channel at V/F curve separation. 0: Keypad: the output voltage is determined by P04.28 . 1: AI1 ; 2: AI2; 3: AI3; 4: HDI;	0	<input type="radio"/>

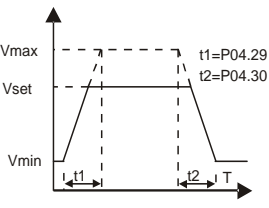
Function code	Name	Description	Default	Modify
		5: Multi-step speed; 6: PID; 7: Modbus communication; 8: PROFIBUS/CANopen communication; 9: Ethernet communication; 10: Reserved Note: 100% corresponds to the rated motor voltage.		
P04.28	Keypad setting voltage	The function code is the voltage displaying when the voltage is set through keypad. The setting range: 0.0%–100.0%	100.0 %	<input type="radio"/>
P04.29	Voltage increasing time	Voltage increasing time is the time when the VFD accelerates from the output minimum voltage to the output maximum voltage.	5.0 s	<input type="radio"/>
P04.30	Voltage decreasing time	Voltage decreasing time is the time when the VFD decelerates from the output maximum voltage to the output minimum voltage. The setting range: 0.0–3600.0s	5.0 s	<input type="radio"/>
P04.31	Maximum output voltage	Set the upper and low limit of the output voltage.	100.0 %	<input checked="" type="radio"/>
P04.32	Minimum output voltage	 <p>Setting range of P04.31: P04.32–100.0% (the rated voltage of the motor) Setting range of P04.32: 0.0%–P04.31</p>	0.0%	<input checked="" type="radio"/>

P05 Group Input terminals

Function code	Name	Description	Default	Modify
P05.00	HDI input	0: High pulse input. See P05.49–P05.54 1: Digital input. See P05.09	0	<input checked="" type="radio"/>
P05.01	S1 terminal function	0: No function 1: Forward rotation operation (FWD)	1	<input checked="" type="radio"/>

Function code	Name	Description	Default	Modify
P05.02	S2 terminal function	2: Reverse rotation operation (REV) 3: 3-wire control operation (SIn)	4	☉
P05.03	S3 terminal function	4: Forward jogging 5: Reverse jogging 6: Coast to stop	7	☉
P05.04	S4 terminal function	7: Fault reset 8: Operation pause 9: External fault input	0	☉
P05.05	S5 terminal function	10: Increasing frequency setting (UP) 11: Decreasing frequency setting (DOWN)	0	☉
P05.06	S6 terminal function	12: Frequency setting clear 13: Shift between A setting and B setting 14: Shift between combination setting and A setting	0	☉
P05.07	S7 terminal function	15: Shift between combination setting and B setting 16: Multi-step speed terminal 1	0	☉
P05.08	S8 terminal function	17: Multi-step speed terminal 2 18: Multi-step speed terminal 3 19: Multi- step speed terminal 4	0	☉
P05.09	HDI terminal function	20: Multi- step speed pause 21: ACC/DEC time 1 22: ACC/DEC time 2 23: Simple PLC stop reset 24: Simple PLC pause 25: PID control pause 26: Forward rotation limit 27: Reverse rotation limit 28: Electronic gear selection 29: Torque control disabling 30: ACC/DEC disabling 31: Pulse ascending 32: Pulse descending 33: Cancel the frequency change setting temporarily 34: DC braking 35: Shift the motor 1 into motor 2 36: Shift the command to the keypad 37: Shift the command to the terminals 38: Shift the command to the communication	0	☉

Function code	Name	Description	Default	Modify																				
		39: Pre-magnetized command 40: Consumption power clear 41: Consumption power holding 42: Keypad setting of the torque upper limit 43: Position reference input (only S8 valid) 44: Spindle direction prohibit 45: Spindle returning /Local position returning 46: Zero position selection 1 47: Zero position selection 2 48: Spindle scaling selection 1 49: Spindle scaling selection 2 50: Spindle scaling selection 3/Pulse superposition enabling 51: Switching terminal of position control and speed control 52: Pulse input disabled 53: Position deviation clear 54: Position proportional gain switch 55: Digital position cycle positioning enabled 56: E-stop 57: Motor overtemperature fault input 58: Rigid tapping enable 59: Switch to SVPWM control 60: Switch to FVC control 61: PID pole switching 62: Undervoltage stopping input 63: Servo enabling																						
P05.10	Polarity selection of the input terminals	The function code is used to set the polarity of the input terminals. Set the bit to 0, the input terminal is anode. Set the bit to 1, the input terminal is cathode. <table border="1" style="margin-left: 20px;"> <tr> <td></td> <td>BIT8</td> <td>BIT7</td> <td>BIT6</td> <td>BIT5</td> </tr> <tr> <td></td> <td>HDI</td> <td>S8</td> <td>S7</td> <td>S6</td> </tr> <tr> <td>BIT4</td> <td>BIT3</td> <td>BIT2</td> <td>BIT1</td> <td>BIT0</td> </tr> <tr> <td>S5</td> <td>S4</td> <td>S3</td> <td>S2</td> <td>S1</td> </tr> </table> Setting range: 0x000–0x1FF		BIT8	BIT7	BIT6	BIT5		HDI	S8	S7	S6	BIT4	BIT3	BIT2	BIT1	BIT0	S5	S4	S3	S2	S1	0x000	○
	BIT8	BIT7	BIT6	BIT5																				
	HDI	S8	S7	S6																				
BIT4	BIT3	BIT2	BIT1	BIT0																				
S5	S4	S3	S2	S1																				
P05.11	ON-OFF filter time	Set the sample filter time of S1–S8 and HDI terminals. If the interference is strong, increase the	0.010s	○																				

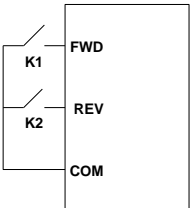
Function code	Name	Description	Default	Modify															
		parameter to avoid the disoperation. 0.000–1.000s																	
P05.12	Virtual terminals setting	0x000–0x1FF (0: Disabled, 1: Enabled) BIT0: S1 virtual terminal BIT1: S2 virtual terminal BIT2: S3 virtual terminal BIT3: S4 virtual terminal BIT4: S5 virtual terminal BIT5: S6 virtual terminal BIT6: S7 virtual terminal BIT7: S8 virtual terminal BIT8: HDI virtual terminal Note: After a virtual terminal is enabled, the state of the terminal can only be modified through communication, and the communication address is 0x200A.	0x000	©															
P05.13	Terminals control running mode	This parameter is used to set the terminal-based control mode. 0: 2-wire control mode 1, integrating the enabling and direction setting functions. This is the most common 2-wire mode. The forward or reverse running of the motor is determined by the defined FWD and REV terminals.  <table border="1" data-bbox="627 973 795 1181"> <thead> <tr> <th>FWD</th> <th>REV</th> <th>Running command</th> </tr> </thead> <tbody> <tr> <td>OFF</td> <td>OFF</td> <td>Stop</td> </tr> <tr> <td>ON</td> <td>OFF</td> <td>Forward running</td> </tr> <tr> <td>OFF</td> <td>ON</td> <td>Reverse running</td> </tr> <tr> <td>ON</td> <td>ON</td> <td>Hold on</td> </tr> </tbody> </table> 1: 2-wire control mode 2, separating the enabling and direction setting functions. The defined FWD terminal is used for enabling, and the direction is determined by the defined REV terminal.	FWD	REV	Running command	OFF	OFF	Stop	ON	OFF	Forward running	OFF	ON	Reverse running	ON	ON	Hold on	0	©
FWD	REV	Running command																	
OFF	OFF	Stop																	
ON	OFF	Forward running																	
OFF	ON	Reverse running																	
ON	ON	Hold on																	

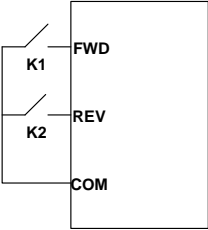
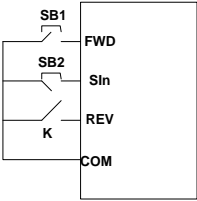
Function code	Name	Description	Default	Modify																																				
		<div style="display: flex; align-items: center;">  <table border="1" style="margin-left: 20px;"> <thead> <tr> <th>FWD</th> <th>REV</th> <th>Running command</th> </tr> </thead> <tbody> <tr> <td>OFF</td> <td>OFF</td> <td>Stop</td> </tr> <tr> <td>ON</td> <td>OFF</td> <td>Forward running</td> </tr> <tr> <td>OFF</td> <td>ON</td> <td>Stop</td> </tr> <tr> <td>ON</td> <td>ON</td> <td>Reverse running</td> </tr> </tbody> </table> </div> <p>2: 3-wire control mode 1. In this mode, SIn is defined as the enabling terminal, the running command is determined by the FWD terminal, and the direction is determined by the REV terminal. When the VFD is running, terminal SIn must be in the connected state. When terminal FWD generates a rising edge signal, the VFD starts to run, and the running direction is determined by terminal REV. To stop the running of the VFD, you need to disconnect terminal SIn.</p> <div style="display: flex; align-items: center; margin-top: 10px;">  </div> <p>The direction control is as below during operation:</p> <table border="1" style="width: 100%; text-align: center;"> <thead> <tr> <th>SIn</th> <th>REV</th> <th>Previous direction</th> <th>Current direction</th> </tr> </thead> <tbody> <tr> <td rowspan="2">ON</td> <td rowspan="2">OFF→ON</td> <td>Forward</td> <td>Reverse</td> </tr> <tr> <td>Reverse</td> <td>Forward</td> </tr> <tr> <td rowspan="2">ON</td> <td rowspan="2">ON→OFF</td> <td>Reverse</td> <td>Forward</td> </tr> <tr> <td>Forward</td> <td>Reverse</td> </tr> <tr> <td rowspan="2">ON→OFF</td> <td>ON</td> <td colspan="2" rowspan="2">Decelerate to stop</td> </tr> <tr> <td>OFF</td> </tr> </tbody> </table> <p>SIn: 3-wire control; FWD: Forward running; REV: Reverse running</p> <p>3: 3-wire control mode 2. In this mode, SIn is</p>	FWD	REV	Running command	OFF	OFF	Stop	ON	OFF	Forward running	OFF	ON	Stop	ON	ON	Reverse running	SIn	REV	Previous direction	Current direction	ON	OFF→ON	Forward	Reverse	Reverse	Forward	ON	ON→OFF	Reverse	Forward	Forward	Reverse	ON→OFF	ON	Decelerate to stop		OFF		
FWD	REV	Running command																																						
OFF	OFF	Stop																																						
ON	OFF	Forward running																																						
OFF	ON	Stop																																						
ON	ON	Reverse running																																						
SIn	REV	Previous direction	Current direction																																					
ON	OFF→ON	Forward	Reverse																																					
		Reverse	Forward																																					
ON	ON→OFF	Reverse	Forward																																					
		Forward	Reverse																																					
ON→OFF	ON	Decelerate to stop																																						
	OFF																																							

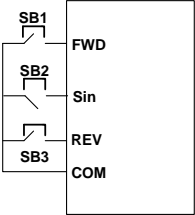
Function code	Name	Description	Default	Modify																				
		<p>defined as the enabling terminal, the running command is determined by the FWD or REV terminal, and the direction is determined by the FWD and REV terminals. When the VFD is running, terminal SIn must be in the connected state. Terminal FWD or REV generates a rising edge signal to run the VFD and determine its running direction, and the running direction is determined by terminal REV. To stop the running of the VFD, you need to disconnect terminal SIn.</p>  <table border="1" data-bbox="397 810 826 1043"> <thead> <tr> <th>SIn</th> <th>FWD</th> <th>REV</th> <th>Direction</th> </tr> </thead> <tbody> <tr> <td rowspan="2">ON</td> <td rowspan="2">OFF→ON</td> <td>ON</td> <td>Forward</td> </tr> <tr> <td>OFF</td> <td>Reverse</td> </tr> <tr> <td rowspan="2">ON</td> <td>ON</td> <td rowspan="2">OFF→ON</td> <td>Forward</td> </tr> <tr> <td>OFF</td> <td>Reverse</td> </tr> <tr> <td>ON→OFF</td> <td></td> <td></td> <td>Decelerate to stop</td> </tr> </tbody> </table> <p>SIn: 3-wire control; FWD: Forward running; REV: Reverse running</p> <p>Note: In 2-wire control modes, if stop commands are generated by other sources, the VFD stops running and does not run again even the FWD and REV terminal are enabled. To run the VFD, you need to trigger the FWD and REV terminals again, users need to trigger FWD/REV again. Other sources that can generate stop commands include PLC single-cycle stop, fixed-length stop, and enabled STOP/RST stop in terminal-based control. (see P07.04).</p>	SIn	FWD	REV	Direction	ON	OFF→ON	ON	Forward	OFF	Reverse	ON	ON	OFF→ON	Forward	OFF	Reverse	ON→OFF			Decelerate to stop		
SIn	FWD	REV	Direction																					
ON	OFF→ON	ON	Forward																					
		OFF	Reverse																					
ON	ON	OFF→ON	Forward																					
	OFF		Reverse																					
ON→OFF			Decelerate to stop																					

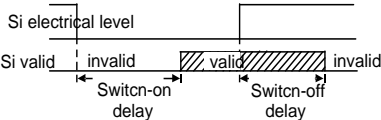
Function code	Name	Description	Default	Modify
P05.14	S1 switch-on delay	<p>The function code defines the corresponding delay time of electrical level of the programmable terminals from switching on to switching off.</p>  <p>Note: P05.30 and P05.31 are valid when P05.00=1.</p> <p>Setting range: 0.000–50.000s</p>	0.000 s	<input type="radio"/>
P05.15	S1 switch-off delay		0.000 s	<input type="radio"/>
P05.16	S2 switch-on delay		0.000 s	<input type="radio"/>
P05.17	S2 switch-off delay		0.000 s	<input type="radio"/>
P05.18	S3 switch-on delay		0.000 s	<input type="radio"/>
P05.19	S3 switch-off delay		0.000 s	<input type="radio"/>
P05.20	S4 switch-on delay		0.000 s	<input type="radio"/>
P05.21	S4 switch-off delay		0.000 s	<input type="radio"/>
P05.22	S5 switch-on delay		0.000 s	<input type="radio"/>
P05.23	S5 switch-off delay		0.000 s	<input type="radio"/>
P05.24	S6 switch-on delay		0.000 s	<input type="radio"/>
P05.25	S6 switch-off delay		0.000 s	<input type="radio"/>
P05.26	S7 switch-on delay		0.000 s	<input type="radio"/>
P05.27	S7 switch-off delay		0.000 s	<input type="radio"/>
P05.28	S8 switch-on delay		0.000 s	<input type="radio"/>
P05.29	S8 switch-off delay		0.000 s	<input type="radio"/>
P05.30	HDI switch-on delay		0.000 s	<input type="radio"/>
P05.31	HDI switch-off delay		0.000 s	<input type="radio"/>

Function code	Name	Description	Default	Modify
P05.32	Lower limit of AI1	The function code defines the relationship between the analog input voltage and its corresponding set value. If the analog input voltage beyond the set minimum or maximum input value, the VFD will count at the minimum or maximum one. When the analog input is the current input, the corresponding voltage of 0–20mA is 0–10 V. In different cases, the corresponding rated value of 100.0% is different. See the application for detailed information.	0.00 V	○
P05.33	Corresponding setting of the lower limit of AI1		0.0%	○
P05.34	Upper limit of AI1		10.00 V	○
P05.35	Corresponding setting of the upper limit of AI1		100.0 %	○
P05.36	AI1 input filter time		0.030s	○
P05.37	Lower limit of AI2	<p>The figure below illustrates different applications:</p>	0.00 V	○
P05.38	Corresponding setting of lower limit of AI2		0.0%	○
P05.39	Upper limit of AI2		10.00 V	○
P05.40	Corresponding setting of upper limit of AI2		100.0 %	○
P05.41	AI2 input filter time		0.100s	○
P05.42	Lower limit of AI3	<p>Input filter time: this parameter is used to adjust the sensitivity of the analog input. Increasing the value properly can enhance the anti-interference of the analog, but weaken the sensitivity of the analog input.</p> <p>Note: Analog AI1 and AI2 can support 0–10 V or 0–20mA input, when AI1 and AI2 selects 0–20mA input, the corresponding voltage of 20mA is 5 V. AI3 can support the output of -10 V–+10 V.</p> <p>Setting range of P05.32: 0.00 V–P05.34</p> <p>Setting range of P05.33: -300.0%–300.0%</p> <p>Setting range of P05.34: P05.32–10.00 V</p> <p>Setting range of P05.35: -300.0%–300.0%</p> <p>Setting range of P05.36: 0.000s–10.000s</p> <p>Setting range of P05.37: 0.00 V–P05.39</p> <p>Setting range of P05.38: -300.0%–300.0%</p>	-10.00 V	○
P05.43	Corresponding setting of lower limit of AI3		-100.0 %	○
P05.44	Zero-drift value of AI3		0.00 V	○
P05.45	Zero-point deadzone voltage of AI3		0.04 V	○
P05.46	Upper limit of AI3		10.00 V	○
P05.47	Corresponding setting of upper limit of AI3		100.0 %	○
P05.48	AI3 input filter time		0.030	○

Function code	Name	Description	Default	Modify
		Setting range of P05.39 : P05.37 –10.00 V Setting range of P05.40 : -300.0%–300.0% Setting range of P05.41 : 0.000s–10.000s Setting range of P05.42 : -10.00 V– P05.44 Setting range of P05.43 : -300.0%–300.0% Setting range of P05.44 : P05.42 – P05.46 Setting range of P05.45 : 0.00–10.00 V Setting range of P05.46 : P05.44 –10.00 V Setting range of P05.47 : -300.0%–300.0% Setting range of P05.48 : 0.000s–10.000s	s	
P05.49	HDI high-speed pulse input function	The function selection when HDI terminals is high-speed pulse input 0: Frequency setting input, frequency setting source 1–2: Reserved	0	☉
P05.50	Lower limit frequency of HDI	0.000 kHz– P05.52	0.000 kHz	○
P05.51	Corresponding setting of HDI low frequency	-300.0%–300.0%	0.0%	○
P05.52	Upper limit frequency of HDI	P05.50 –50.000 kHz	50.000 kHz	○
P05.53	Corresponding setting of upper limit frequency of HDI	-300.0%–300.0%	100.0 %	○
P05.54	HDI frequency input filter time	0.000s–10.000s	0.030s	○

P06 Group Output terminals

Function code	Name	Description	Default	Modify
P06.00	HDO output	The function selection of the high-speed pulse output terminals. 0: Open collector pole high speed pulse output; The Max pulse frequency is 50.0 kHz. See P06.27 – P06.31 for detailed information of the	0	☉

Function code	Name	Description	Default	Modify
		related functions. 1: Open collector pole output. See P06.02 for detailed information of the related functions.		
P06.01	Y1 output	0: Invalid	0	○
P06.02	HDO output	1: In operation	0	○
P06.03	Relay RO1 output	2: Forward rotation operation 3: Reverse rotation operation	1	○
P06.04	Relay RO2 output	4: Jogging operation 5: The VFD fault 6: Frequency degree test FDT1 7: Frequency degree test FDT2 8: Frequency arrival 9: Zero speed running 10: Upper limit frequency arrival 11: Lower limit frequency arrival 12: Ready for operation 13: In pre-exciting 14: Overload pre-alarm 15: Underload pre-alarm 16: Completion of simple PLC stage 17: Completion of simple PLC cycle 18: Reach set counting value 19: Reach specified counting value 20: External fault is valid 21: Reserved 22: Reach running time 23: Modbus communication virtual terminals output 24: PROFIBUS/CANopen communication virtual terminals output 25: Ethernet communication virtual terminals output 26: DC bus voltage established 27: Reserved 28: Pulse superposing 29: Reserved 30: Positioning finished 31: Zero returning 32: Spindle scaling 33: Speed limit reached in torque control 34: Low bus voltage 35: Undervoltage stopping output 36: Speed/position switching finished 37-40: Reserved	5	○

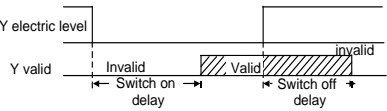
Function code	Name	Description	Default	Modify								
P06.05	Polarity of output terminals	<p>The function code is used to set the pole of the output terminal.</p> <p>When the current bit is set to 0, input terminal is positive.</p> <p>When the current bit is set to 1, input terminal is negative.</p> <table border="1" style="margin-left: auto; margin-right: auto;"> <tr> <td>BIT0</td> <td>BIT1</td> <td>BIT2</td> <td>BIT3</td> </tr> <tr> <td>Y1</td> <td>HDO</td> <td>RO1</td> <td>RO2</td> </tr> </table> <p>Setting range: 0x0–0xF</p>	BIT0	BIT1	BIT2	BIT3	Y1	HDO	RO1	RO2	0x0	○
BIT0	BIT1	BIT2	BIT3									
Y1	HDO	RO1	RO2									
P06.06	Y1 switch-on delay	<p>The function code defines the corresponding delay time of the electrical level change during the programmable terminal switching on and off.</p>  <p>The setting range : 0.000–50.000s</p> <p>Note: P06.08 and P06.08 are valid only when P06.00=1.</p>	0.000 s	○								
P06.07	Y1 switch-off delay		0.000 s	○								
P06.08	HDO switch-on delay		0.000 s	○								
P06.09	HDO switch-off delay		0.000 s	○								
P06.10	RO1 switch-on delay		0.000 s	○								
P06.11	RO1 switch-off delay		0.000 s	○								
P06.12	RO2 switch-on delay		0.000 s	○								
P06.13	RO2 switch-off delay		0.000 s	○								
P06.14	AO1 output		0: Running frequency	0	○							
P06.15	AO2 output		1: Set frequency	0	○							
P06.16	HDO high-speed pulse output	<p>2: Ramps reference frequency</p> <p>3: Running speed</p> <p>4: Output current (relative to 2 times the rated current of the VFD)</p> <p>5: Output current (relative to 2 times the rated current of the motor)</p> <p>6: Output voltage (relative to 1.5 times the rated voltage of the VFD)</p> <p>7: Output power (relative to 2 times the rated power of the motor)</p>	0	○								

Function code	Name	Description	Default	Modify
		8: Set torque value (relative to 2 times the rated torque of the motor) 9: Output torque (relative to 2 times the rated torque of the motor) 10: Analog AI1 input value 11: Analog AI2 input value 12: Analog AI3 input value 13: Input value of high-speed pulse HDIA 14: Set value 1 of Modbus communication 15: Set value 2 of Modbus communication 16: Set value 1 of PROFIBUS/CANopen communication 17: Set value 2 of PROFIBUS/CANopen communication 18: Set value 1 of Ethernet communication 19: Set value 2 of Ethernet communication 20–21: Reserved 22: Torque current (bipolar, 100% corresponds to 10 V) 23: Excitation current (100% corresponds to 10 V) 24: Setting frequency (bipolar) 25: Ramp reference frequency (bipolar) 26: Operation speed (bipolar) 27: Operation speed (positive polarity)		
P06.17	Lower output limit of AO1	The above function codes define the relative relationship between the output value and analog output. When the output value exceeds the range of set maximum or minimum output, it will count according to the low-limit or upper-limit output. When the analog output is current output, 1mA equals to 0.5 V. In different cases, the corresponding analog output of 100% of the output value is different. See each application for detailed information. Please refer to section 0 "Frequency setting" for more details.	0.0%	<input type="radio"/>
P06.18	Corresponding AO1 output of lower limit		0.00 V	<input type="radio"/>
P06.19	Upper output limit of AO1		100.0 %	<input type="radio"/>
P06.20	Corresponding AO1 output of upper limit		10.00 V	<input type="radio"/>
P06.21	AO1 output filter time		0.000 s	<input type="radio"/>
P06.22	Lower output limit		0.0%	<input type="radio"/>

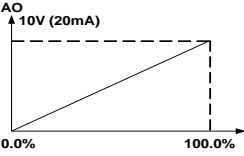
Function code	Name	Description	Default	Modify
	of AO2			
P06.23	Corresponding AO2 output of lower limit		0.00 V	<input type="radio"/>
P06.24	Upper output limit of AO2	Setting range of P06.17 : -300.0%– P06.19	100.0 %	<input type="radio"/>
P06.25	Corresponding AO2 output of upper limit	Setting range of P06.18 : 0.00 V–10.00 V Setting range of P06.19 : P06.17 –300.0% Setting range of P06.20 : 0.00 V–10.00 V	10.00 V	<input type="radio"/>
P06.26	AO2 output filter time	Setting range of P06.21 : 0.000s–10.000s Setting range of P06.22 : -300.0%– P06.24	0.000 s	<input type="radio"/>
P06.27	Lower output limit of HDO	Setting range of P06.23 : 0.00 V–10.00 V Setting range of P06.24 : P06.22 –300.0%	0.00%	<input type="radio"/>
P06.28	Corresponding HDO output of lower limit	Setting range of P06.25 : 0.00 V–10.00 V Setting range of P06.26 : 0.000s–10.000s Setting range of P06.27 : -300.0%– P06.29	0.0 kHz	<input type="radio"/>
P06.29	Upper output limit of HDO	Setting range of P06.28 : 0.00–50.00 kHz Setting range of P06.29 : P06.27 –300.0%	100.0 %	<input type="radio"/>
P06.30	Corresponding HDO output of upper limit	Setting range of P06.30 : 0.00–50.00 kHz Setting range of P06.31 : 0.000s–10.000s	50.00 kHz	<input type="radio"/>
P06.31	HDO output filter time		0.000 s	<input type="radio"/>

P07 Group HMI

Function code	Name	Description	Default	Modify
P07.00	User's password	0–65535 The password protection will be valid when setting any non-zero number. 00000: Clear the previous user's password, and make the password protection invalid. After the set user's password becomes valid, if the password is incorrect, users cannot enter the parameter menu. Only correct password can make the user check or modify the parameters. Please remember all users' passwords.	0	<input type="radio"/>

Function code	Name	Description	Default	Modify
		<p>Retreat editing state of the function codes and the password protection will become valid in minute. If the valid password is available, press PRG/ESC to enter into the editing state of the function codes, and then "0.0.0.0.0" will be displayed. Unless input right password, the operator cannot enter into it.</p> <p>Note: Restoring to the default value can clear the password, please use it with caution.</p>		
P07.01	Parameter copy	<p>The function code determines the manner of parameters copy.</p> <p>0: No operation</p> <p>1: Upload the local function parameter to the keypad</p> <p>2: Download the keypad function parameter to local address (including the motor parameters)</p> <p>3: Download the keypad function parameter to local address (excluding the motor parameter of P02 and P12 group)</p> <p>4: Download the keypad function parameters to local address (only for the motor parameter of P02 and P12 group)</p> <p>Note: After completing the 1–4 operations, the parameter will come back to 0 automatically; the function of upload and download excludes the factory parameters of P29.</p>	0	⊙
P07.02	<p>QUICK/JOG function selection</p>	<p>0: No function</p> <p>1: Jogging. Press QUICK/JOG to begin the jogging running.</p> <p>2: Shift the display state by the shifting key. Press QUICK/JOG to shift the displayed function code from right to left.</p> <p>3: Shift between forward rotations and reverse rotations. Press QUICK/JOG to shift the direction of the frequency commands. This function is only valid in the keypad commands channels.</p> <p>4: Clear UP/DOWN settings. Press QUICK/JOG to clear the set value of UP/DOWN.</p>	1	⊙

Function code	Name	Description	Default	Modify
		<p>5: Coast to stop. Press QUICK/JOG to coast to stop.</p> <p>6: Shift the given manner of running commands. Press QUICK/JOG to shift the given manner of running commands.</p> <p>7: Quick commission mode (commission according to the non-factory parameter)</p> <p>Note: Press QUICK/JOG to shift between forward rotation and reverse rotation, the VFD does not remember the state after shifting during powering off. The VFD will run in the running direction set according to parameter P00.13 during next powering on.</p>		
P07.03	Shifting sequence selection of QUICK/JOG commands	<p>When P07.06=6, set the shifting sequence of running command channels.</p> <p>0: Keypad control→terminals control →communication control</p> <p>1: Keypad control←→terminals control</p> <p>2: Keypad control←→communication control</p> <p>3: Terminals control←→communication control</p>	0	○
P07.04	STOP/RST stop function	<p>STOP/RST is valid for stop function. STOP/RST is valid in any state for the fault reset.</p> <p>0: Only valid for the keypad control</p> <p>1: Both valid for keypad and terminals control</p> <p>2: Both valid for keypad and communication control</p> <p>3: Valid for all control modes</p>	0	○
P07.05	Parameters state 1	<p>0x0000–0xFFFF</p> <p>BIT0: Running frequency (Hz on)</p> <p>BIT1: Set frequency (Hz flickering)</p> <p>BIT2: Bus voltage (Hz on)</p> <p>BIT3: Output voltage (V on)</p> <p>BIT4: Output current (A on)</p> <p>BIT5: Running rotation speed (rpm on)</p> <p>BIT6: Output power (% on)</p> <p>BIT7: Output torque (% on)</p> <p>BIT8: PID reference (% flickering)</p> <p>BIT9: PID feedback value (% on)</p>	0x03FF	○

Function code	Name	Description	Default	Modify
		BIT10: Input terminals state BIT11: Output terminals state BIT12: Torque set value (% on) BIT13: Pulse counter value BIT14: Length value BIT15: PLC and the current stage in multi-step speed		
P07.06	Parameters state 2	0x0000–0xFFFF BIT0: AI1 (V on) BIT1: AI2 (V on) BIT2: AI3 (V on) BIT3: HDI frequency BIT4: Motor overload percentage (% on) BIT5: VFD overload percentage (% on) BIT6: Ramp frequency given value (Hz on) BIT7: Linear speed BIT8: AC inlet current (A on) BIT9–15: Reserved	0x0000	
P07.07	Parameters for stopping state	0x0000–0xFFFF BIT0: Set frequency (Hz on, frequency flickering slowly) BIT1: Bus voltage (V on) BIT2: Input terminals state BIT3: Output terminals state BIT4: PID reference (% flickering) BIT5: PID feedback value (% flickering) BIT6: Torque reference (% flickering) BIT7: AI1 (V on) BIT8: AI2 (V on) BIT9: AI3 (V on) BIT10: HDI frequency BIT11: PLC and the current stage in multi-step speed BIT12: Pulse counters BIT13: Length value BIT14–BIT15: Reserved	0x00FF	○
P07.08	Frequency	0.01–10.00	1.00	○

Function code	Name	Description	Default	Modify
	coefficient	Displayed frequency=running frequency* P07.08		
P07.09	Rotation speed coefficient	0.1–999.9% Mechanical rotation speed =120*displayed running frequency× P07.09 /motor pole pairs	100.0 %	○
P07.10	Linear speed coefficient	0.1–999.9% Linear speed= Mechanical rotation speed× P07.10	1.0%	○
P07.11	Rectifier bridge module temperature	-20.0–120.0°C		●
P07.12	Inverter module temperature	-20.0–120.0°C		●
P07.13	Software version	1.00–655.35		●
P07.14	Local accumulative running time	0–65535h		●
P07.15	MSB of power consumption	Display the power used by the VFD. The power consumption of the VFD = P07.15 *1000+ P07.16		●
P07.16	LSB of power consumption	Setting range of P07.15 : 0–65535 kWh (*1000) Setting range of P07.16 : 0.0–999.9 kWh		●
P07.17	Reserved	Reserved		●
P07.18	Rated VFD power	0.4–3000.0 kW		●
P07.19	Rated VFD voltage	50–1200 V		●
P07.20	Rated VFD current	0.1–6000.0A		●
P07.21	Factory barcode 1	0x0000–0xFFFF		●
P07.22	Factory barcode 2	0x0000–0xFFFF		●
P07.23	Factory barcode 3	0x0000–0xFFFF		●
P07.24	Factory barcode 4	0x0000–0xFFFF		●
P07.25	Factory barcode 5	0x0000–0xFFFF		●
P07.26	Factory barcode 6	0x0000–0xFFFF		●
P07.27	Current fault type	0: No fault		●
P07.28	Type of the last fault	1: Inverter unit phase protection (OUT1) 2: Inverter unit V phase protection (OUT2)		●
P07.29	Type of the last but one fault	3: Inverter unit W phase protection (OUT3) 4: ACC overcurrent (OC1)		●
P07.30	Type of the last but two fault	5: DEC overcurrent (OC2) 6: Constant-speed overcurrent (OC3)		●

Function code	Name	Description	Default	Modify
P07.31	Type of the last but three fault	7: ACC overvoltage (OV1) 8: DEC overvoltage (OV2)		●
P07.32	Type of the last but four fault	9: Constant-speed overvoltage (OV3) 10: Bus undervoltage (UV) 11: Motor overload (OL1) 12: VFD overload (OL2) 13: Input side phase loss (SPI) 14: Output side phase loss (SPO) 15: Overheat of the rectifier module (OH1) 16: Overheat fault of the inverter module (OH2) 17: External fault (EF) 18: 485 communication fault (CE) 19: Current detection fault (ItE) 20: Motor autotune fault (tE) 21: EEPROM operation fault (EEP) 22: PID response offline fault (PIDE) 23: Braking unit fault (bCE) 24: Running time arrival (END) 25: Electrical overload (OL3) 26: Panel communication fault (PCE) 27: Parameter uploading fault (UPE) 28: Parameter downloading fault (DNE) 29: PROFIBUS communication fault (E-DP) 30: Ethernet communication fault (E-NET) 31: CANopen communication fault (E-CAN) 32: Grounding short circuit fault 1 (ETH1) 33: Grounding short circuit fault 2 (ETH2) 34: Speed deviation fault (dEu) 35: Maladjustment (STu) 36: Undervoltage fault (LL) 37: Encoder offline fault (ENC1o) 38: Encoder reverse fault (ENC1d) 39: Encoder pulse Z offline fault (ENC1Z) 43: Motor overtemperature fault (OT)		●
P07.33	Running frequency at present fault		0.00 Hz	●
P07.34	Ramp reference frequency at present fault		0.00 Hz	

Function code	Name	Description	Default	Modify
P07.35	Output voltage at present fault		0 V	
P07.36	Output current at present fault		0.0 A	
P07.37	Bus voltage at present fault		0.0 V	
P07.38	Max temperature at present fault		0.0°C	
P07.39	Input terminal state at present fault		0	●
P07.40	Output terminal state at present fault		0	●
P07.41	Running frequency at last fault		0.00 Hz	●
P07.42	Ramp reference frequency at last fault		0.00 Hz	●
P07.43	Output voltage at last fault		0 V	●
P07.44	Output current at last fault		0.0 A	●
P07.45	Bus voltage at last fault		0.0 V	●
P07.46	Max temperature at last fault		0.0°C	●
P07.47	Input terminals state at last fault		0	●
P07.48	Output terminal state at last fault		0	●
P07.49	Running frequency at last but one fault		0.00 Hz	●
P07.50	Output voltage at last but one fault		0.00 Hz	●
P07.51	Output current at last but one fault		0 V	●
P07.52	Output current at last but one fault		0.0 A	●
P07.53	Bus voltage at last but one fault		0.0 V	●
P07.54	Highest temperature at last but one fault		0.0°C	●
P07.55	Input terminal state at last but one fault		0	●
P07.56	Output terminal state at last but one fault		0	●

P08 Group Enhanced functions

Function code	Name	Description	Default	Modify
P08.00	ACC time 2	For detailed definition, see the description of P00.11 and P00.12 .	Depend on model	○
P08.01	DEC time 2	Four groups of ACC and DEC time are defined for the Goodrive35 series. You can set the ACC and DEC time through the corresponding multi-function digital input terminals (in the P05 group). For the	Depend on model	○

Function code	Name	Description	Default	Modify
P08.02	ACC time 3	Goodrive35 series VFD, the default setting is the first group of ACC and DEC time. Setting range: 0.0–3600.0s	Depend on model	<input type="radio"/>
P08.03	DEC time 3		Depend on model	<input type="radio"/>
P08.04	ACC time 4		Depend on model	<input type="radio"/>
P08.05	DEC time 4		Depend on model	<input type="radio"/>
P08.06	Jogging frequency		This parameter is used to set the reference frequency of the VFD during jogging. Setting range: 0.00 Hz– P00.03 (max. output frequency)	5.00 Hz
P08.07	Jogging ACC time	P08.07 indicates the time the VFD takes to accelerate from 0 Hz to P00.03 (max. output frequency).	Depend on model	<input type="radio"/>
P08.08	Jogging DEC time	P08.08 indicates the time the VFD takes to decelerate from P00.03 (max. output frequency) to 0 Hz. Setting range: 0.0–3600.0s	Depend on model	<input type="radio"/>
P08.09	Jumping frequency 1	When the set frequency is in the range of jumping frequency, the VFD will run at the edge of the jumping frequency. The VFD can avoid the mechanical resonance point by setting the jumping frequency. The VFD can set three jumping frequency. But this function will be invalid if all jumping points are 0.	0.00 Hz	<input type="radio"/>
P08.10	Jumping frequency range 1		0.00 Hz	<input type="radio"/>
P08.11	Jumping frequency 2		0.00 Hz	<input type="radio"/>
P08.12	Jumping frequency range 2		0.00 Hz	<input type="radio"/>
P08.13	Jumping frequency 3		0.00 Hz	<input type="radio"/>
P08.14	Jumping frequency range 3		0.00 Hz	<input type="radio"/>

Function code	Name	Description	Default	Modify
		Setting range: 0.00 Hz– P00.03 (max. output frequency)		
P08.15	Overvoltage stall modulator gain	Setting range: 0.0–1000.0	12.0	<input type="radio"/>
P08.16	ASR differential gain	Setting range: 0.00–10.00s	0.00 s	<input type="radio"/>
P08.17	Max torque of inertia compensation	Limit the max. inertia compensation torque to prevent the inertia compensation torque from being too large. Setting range: 0.0–150.0% (rated torque of the motor)	20.0%	<input type="radio"/>
P08.18	Inertia compensation filter times	Filter times of inertia compensation torque is used to smooth the inertia compensation torque. Setting range: 0–10	7	<input type="radio"/>
P08.19	High-frequency ACR proportional coefficient	In the closed-loop vector control mode (P00.00 =3), when the running frequency is lower than the ACR high frequency switching point (P08.21), the ACR PI parameters are P03.09 and P03.10; and when the running frequency is higher than the ACR high frequency switching point, the ACR PI parameters are P08.19 and P08.20. Setting range of P08.19 : 0–20000 Setting range of P08.20 : 0–20000 Setting range of P08.21 : 0.0–100.0% (relative max frequency)	1000	<input type="radio"/>
P08.20	High-frequency ACR integral coefficient		1000	<input type="radio"/>
P08.21	ACR high frequency switching point		100.0 %	<input type="radio"/>
P08.22	Inertia identification torque	Because of the friction, it is necessary to set identification torque for normal inertia identification. 0.0–100.0% (rated torque of the motor)	10.0%	<input checked="" type="radio"/>
P08.23	Inertia identification	0: No operation 1: Starting identification: press "RUN" to enter into the program after starting identification until display "-END-"; the identified system inertia is saved in P08.24 .	0	<input checked="" type="radio"/>
P08.24	System inertia	The identified system inertia can be set manually when the system inertia is known. The displayed system inertia may be less than 0.001kgm ² for the motors below 1 kW. Setting range: 0.000–30.000 kgm ²	0.000 kgm ²	<input type="radio"/>

Function code	Name	Description	Default	Modify
P08.25	Inertia compensation enabled	Identifying the system inertia correctly and enabling the inertia compensation can improve the dynamic response of the system. 0: Enabled 1: Disabled	0	<input type="radio"/>
P08.26	Stopping protection for undervoltage	Ones: Enabling 0: Disabled 1: Enabled Tens: Voltage selection 0: Internal setting 1: P8.27 setting After the valid undervoltage stopping, the VFD will decelerate to stop according to the DEC time set by P08.05 .	0x00	<input type="radio"/>
P08.27	Stopping voltage for undervoltage	Setting range: 250.0–1000.0 V	450.0 V	<input type="radio"/>
P08.28	Automatic fault reset times	Automatic fault reset times: When the VFD selects automatic fault reset, it is used to set the times of automatic reset, if the continuous reset times exceeds the value set by P08.28 , the VFD will report fault and stop to wait for repair.	0	<input type="radio"/>
P08.29	Interval time of automatic fault reset	Interval of automatic fault reset: Select the interval time from when fault occurred to automatic fault reset actions. After VFD starts, if no fault occurred during 60s, the fault reset times will be zeroed out. Setting range of P08.28 : 0–10 Setting range of P08.29 : 0.1–3600.0s	1.0 s	<input type="radio"/>
P08.30	Frequency decreasing ratio of the dropping control	The output frequency of the VFD changes as the load. And it is mainly used to balance the power when several VFDs drive one load. Setting range: 0.00–50.00 Hz	0.00 Hz	<input type="radio"/>
P08.31	Motor shifting	Goodrive35 supports the shift between two motors. This function is used to select the shifting channel. 0: Terminal shifting; digital terminal is 35 1: Modbus communication shifting 2: PROFIBUS/CANopen communication shifting	0	<input checked="" type="radio"/>

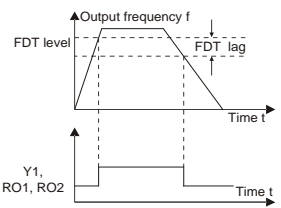
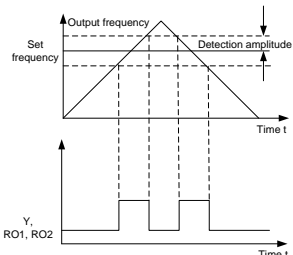
Function code	Name	Description	Default	Modify
P08.32	FDT1 electrical level detection value	When the output frequency exceeds the corresponding frequency of FDT electrical level, the multi-function digital output terminals will output the signal of "frequency level detect FDT" until the output frequency decreases to a value lower than (FDT electrical level—FDT retention detection value) the corresponding frequency, the signal is invalid. Below is the waveform diagram:	50.00 Hz	<input type="radio"/>
P08.33	FDT1 retention detection value		5.0%	<input type="radio"/>
P08.34	FDT2 electrical level detection value		50.00 Hz	<input type="radio"/>
P08.35	FDT2 retention detection value	 <p>Setting range of P08.32: 0.00 Hz–P00.03 (max. output frequency) Setting range of P08.33: -200.0–100.0% (FDT1 electrical level) Setting range of P08.34: 0.00 Hz–P00.03 (max. output frequency) Setting range of P08.35: -200.0–100.0% (FDT2 electrical level)</p>	5.0%	<input type="radio"/>
P08.36	Amplitude value for frequency arrival detection	<p>When the output frequency is among the positive or negative detection range of the set frequency, the multi-function digital output terminal will output the signal of "frequency arrival", see the diagram below for detailed information:</p>  <p>The setting range: 0.00 Hz–P00.03 (max. output</p>	0.00 Hz	<input type="radio"/>

Function code	Name	Description	Default	Modify
		frequency)		
P08.37	Energy braking enable	This parameter is used to control the internal braking pipe inside the VFD. 0: Disable 1: Enable Note: Only applied to internal braking pipe.	1	○
P08.38	Threshold voltage of dynamic braking	Set the starting bus voltage of dynamic braking, adjust this value properly to braking the load effectively. The default value changes with voltage level Setting range: 200.0–2000.0 V	380 V voltage: 700.0 V 660 V voltage: 1120.0 V	○
P08.39	Cooling fan running mode	0: Normal mode 1: The fan keeps running after power on	0	○
P08.40	PWM selection	0x000–0x111 LED ones: PWM mode setting 0: PWM mode 1, 3PH and 2PH modulation 1: PWM mode 2, 3PH modulation LED tens: Low-speed carrier frequency limiting mode 0: Reducing the carrier frequency at low speed, limiting the carrier frequency to 4 kHz when the machine runs at low speed. This mode is valid only for the closed-loop vector mode (P00.00=3). 1: No reducing the carrier frequency at low speed Hundreds place: Dead-zone compensation method	0x001	◎
P08.41	Overmodulation	0x00–0x91 Ones: Overmodulation selection 0: Invalid 1: Valid Tens: Heavy overmodulation factor 0–9	0x01	◎
P08.42	Keypad data control	0x0000–0x1223 LED ones: Frequency enable selection 0: Both \wedge/\vee keys and digital potentiometer adjustments are valid	0x000 0	○

Function code	Name	Description	Default	Modify
		1: Only \wedge/\vee keys adjustment is valid 2: Only digital potentiometer adjustments is valid 3: Neither \wedge/\vee keys nor digital potentiometer adjustments are valid LED tens: Frequency control selection 0: Only valid when P00.06 =0 or P00.07 =0 1: Valid for all frequency setting manner 2: Invalid for multi-step speed when multi-step speed has the priority LED hundreds: Action selection during stopping 0: Setting is valid 1: Valid during running, cleared after stopping 2: Valid during running, cleared after receiving the stop command LED thousands: \wedge/\vee keys and digital potentiometer integral function 0: The integral function is valid 1: The integral function is invalid		
P08.43	Integral ratio of keypad potentiometer	0.01–10.00 s	0.10 Hz/s	○
P08.44	UP/DOWN terminals control	0x000–0x221 LED ones: frequency control selection 0: UP/DOWN terminals setting valid 1: UP/DOWN terminals setting valid LED tens: frequency control selection 0: Only valid when P00.06 =0 or P00.07 =0 1: All frequency means are valid 2: When the multi-step are priority, it is invalid to the multi-step LED hundreds: action selection when stop 0: Setting valid 1: Valid in the running, clear after stop 2: Valid in the running, clear after receiving the stop commands	0x000	○

Function code	Name	Description	Default	Modify
P08.45	UP terminals frequency changing ratio	0.01–50.00 Hz/s	0.50 Hz/s	<input type="radio"/>
P08.46	DOWN terminals frequency changing ratio	0.01–50.00 Hz/s	0.50 Hz/s	<input type="radio"/>
P08.47	Frequency setting at power loss	0x000–0x121 LED ones: Action selection when power off. 0: Save when power off 1: Clear when power off LED tens: Action selection when Modbus set frequency off 0: Save when power off 1: Clear when power off 2: Clear when stop LED hundreds: The action selection when other frequency set frequency off 0: Save when power off 1: Clear when power off	0x000	<input type="radio"/>
P08.48	MSB of initial power consumption	This parameter is used to set the original value of the power consumption. The original value of the power consumption	0°	<input type="radio"/>
P08.49	LSB of initial power consumption	= P08.48 *1000+ P08.49 Setting range of P08.48 : 0–59999 kWh (k) Setting range of P08.49 : 0.0–999.9 kWh	0.0°	<input type="radio"/>
P08.50	Magnetic flux braking	This function code is used to enable magnetic flux. 0: Invalid. 100–150: The bigger the coefficient, the stronger the braking is. This VFD is used to increase the magnetic flux to decelerate the motor. The energy generated by the motor during braking can be converted into heat energy by increasing the magnetic flux. The VFD monitors the state of the motor continuously even during the magnetic flux period. So the magnetic flux can be used in the motor stop, as well as to change the rotation speed of the motor. Its other advantages are:	0	<input checked="" type="radio"/>

Function code	Name	Description	Default	Modify
		Braking immediately after the stop command. It does not need to wait the magnetic flux weaken. Better cooling for motors. The current of the stator other than the rotor increases during magnetic flux braking, while the cooling of the stator is more effective than the rotor.		
P08.51	Current regulation coefficient on input side	This function code is used to adjust the displayed current of the AC input side. Setting range: 0.00–1.00	0.56	<input type="radio"/>

P09 Group PID control

Function code	Name	Description	Default	Modify
P09.00	PID reference source	<p>When the frequency command selection (P00.06, P00.07) is 7 or the voltage setting channel selection (P04.27) is 6, the running mode of the VFD is procedure PID controlled.</p> <p>The parameter determines the target given channel during the PID procures.</p> <p>0: Set by P09.01</p> <p>1: AI1</p> <p>2: AI2</p> <p>3: AI3</p> <p>4: HDI</p> <p>5: Multi-step speed set</p> <p>6: Modbus communication set</p> <p>7: PROFIBUS/CANopen communication set</p> <p>8: Ethernet communication set</p> <p>9: Reserved</p> <p>The setting target of procedure PID is a relative one, 100% of the setting equals to 100% of the response of the controlled system.</p> <p>The system is calculated according to the relative value (0–100.0%).</p> <p>Note:</p> <p>Multi-step speed reference, it is realized by setting P10 group parameters. PROFIBUS, Ethernet and CANopen communication setting need corresponding expansion cards.</p>	0	<input type="radio"/>

Function code	Name	Description	Default	Modify
P09.01	PID value reference	When P09.00 =0, set the parameter whose basic value is the response value of the system. The setting range: -100.0%–100.0%	0.0%	<input type="radio"/>
P09.02	PID feedback source	Select the PID channel by the parameter. 0: AI1 1: AI2 2: AI3 3: HDI 4: Modbus communication feedback 5: PROFIBUS/CANopen communication feedback 6: Ethernet communication feedback 7: Reserved Note: The reference and feedback channel cannot coincide, otherwise, PID cannot control effectively.	0	<input type="radio"/>
P09.03	PID output feature	0: PID output is positive: when the feedback signal exceeds the PID given value, the output frequency of the VFD will decrease to balance the PID. For example, the strain PID control during winding. 1: PID output is negative: When the feedback signal is stronger than the PID given value, the output frequency of the VFD will increase to balance PID. For example, the strain PID control during unwinding.	0	<input type="radio"/>
P09.04	Proportional gain (Kp)	The function is applied to the proportional gain P of PID input. P determines the strength of the whole PID adjuster. The parameter of 100 means that when the offset of PID feedback and given value is 100%, the adjusting range of PID adjuster is the Max frequency (ignoring integral and differential function). Setting range: 0.00–100.00	1.00	<input type="radio"/>
P09.05	Integral time (Ti)	This parameter determines the speed of PID adjuster to carry out integral adjustment on the deviation of PID feedback and reference. When the deviation of PID feedback and reference is 100%, the integral adjuster works continuously after the time (ignoring the proportional effect and	1.00 s	<input type="radio"/>

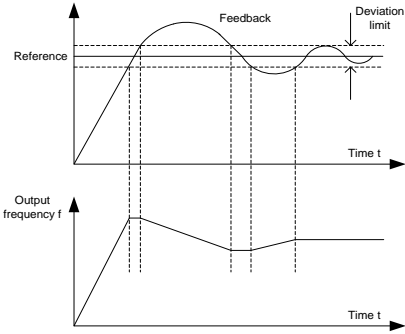
Function code	Name	Description	Default	Modify
		differential effect) to achieve max. output frequency (P00.03) or the max voltage (P04.31). Shorter the integral time, stronger is the adjustment Setting range: 0.00–50.00s		
P09.06	Differential time (Td)	This parameter determines the strength of the change ratio when PID adjustor carries out integral adjustment on the deviation of PID feedback and reference. If the PID feedback changes 100% during the time, the adjustment of integral adjustor (ignoring the proportional effect and differential effect) is max. output frequency (P00.03) or the max voltage (P04.31). Longer the integral time, stronger is the adjusting. Setting range: 0.00–10.00s	0.00 s	○
P09.07	Sampling cycle (T)	This parameter means the sampling cycle of the feedback. The adjustor operates each sampling cycle. The longer the sapling cycle is, the slower the response is. Setting range: 0.001–1.000 s	0.001 s	○
P09.08	PID control deviation limit	The output of PID system is the maximum deviation relative to closed-loop reference. As shown in the diagram below, PID adjustor stops to work during the deviation limit. Set the function properly to adjust the accuracy and stability of the system.  Setting range: 0.0–100.0%	0.0%	○

Function code	Name	Description	Default	Modify
P09.09	Output upper limit of PID	This parameter is used to set the upper and lower limit of the PID adjustor output.	100.0 %	<input type="radio"/>
P09.10	Output lower limit of PID	100.0 % corresponds to max. output frequency (P00.03) or the max voltage of (P04.31) Setting range of P09.09: P09.10–100.0% Setting range of P09.10: -100.0%–P09.09	-50.0 %	<input type="radio"/>
P09.11	Detection value of feedback offline	Set the detection value of feedback offline, when the feedback detection value is smaller than or equals to the detected value, and the lasting time exceeds the set value in P09.12, the VFD will report "PID feedback offline fault" and keypad will display PIDE.	0.0%	<input type="radio"/>
P09.12	Detection time of feedback offline	<p>Setting range of P09.11: 0.0–100.0% Setting range of P09.12: 0.0–3600.0 s</p>	1.0 s	<input type="radio"/>
P09.13	PID adjustment	0x000–0x111 LED ones: 0: Keep on integral adjustment when the frequency achieves the upper and low limit; the integration shows the change between the reference and the feedback unless it reaches the internal integral limit. When the trend between the reference and the feedback changes, it needs more time to offset the impact of continuous working and the integration will change with the trend. 1: Stop integral adjustment when the frequency achieves the upper and low limit. If the integration keeps stable, and the trend between the reference and the feedback changes, the integration will change with the trend quickly. LED tens: P00.08 is 0	0x001	<input type="radio"/>

Function code	Name	Description	Default	Modify
		0: The same with the setting direction; if the output of PID adjustment is different from the current running direction, the internal will output 0 forcedly. 1: Opposite to the setting direction; if the output of PID adjustment is different from the current running direction, operate the close-loop adjustment output that is opposite to current running direction.. LED hundreds: P00.08 is 0 0: Limit to the maximum frequency 1: Limit to frequency A		
P09.14	PID deviation limit	0.0–200.0%	200.0 %	<input type="radio"/>
P09.15	PID command of ACC/DEC time	0.0–1000.0s	0.0 s	<input type="radio"/>
P09.16	PID output filter time	0.000–10.000s	0.000 s	<input type="radio"/>
P09.17	PID pre-setting	-100.0–100.0%	0.0%	<input type="radio"/>

P10 Group Simple PLC and multi-step speed control

Function code	Name	Description	Default	Modify
P10.00	Simple PLC	0: Stop after running once. The VFD has to be commanded again after finishing a cycle. 1: Run at the final value after running once. After finish a signal, the VFD will keep the running frequency and direction of the last run. 2: Cycle running. The VFD keeps running until receiving a stop command, then system will stop.	0	<input type="radio"/>
P10.01	Simple PLC memory	0: Power loss without memory 1: Power loss with memory; PLC record the running stage and frequency when power loss.	0	<input type="radio"/>
P10.02	Multi-step speed 0	The frequency setting range of stage 0–15:	0.0%	<input type="radio"/>
P10.03	Running time of step 0	-100.0–100.0%, 100.0% of the frequency setting corresponds to max. output frequency P00.03 .	0.0 s	<input type="radio"/>
P10.04	Multi-step speed 1	The operation time setting of stage 0–15: the time	0.0%	<input type="radio"/>
P10.05	The running time	unit is determined by P10.37 ..	0.0 s	<input type="radio"/>

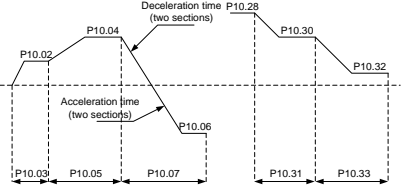
Function code	Name	Description	Default	Modify
	of step 1	<p>When selecting simple PLC running, set P10.02–P10.33 to define the running frequency and time of all stages.</p> <p>Note: The symbol of multi-step determines the running direction of simple PLC. The negative value means reverse rotation.</p> 	0.0%	○
P10.06	Multi-step speed 2		0.0 s	○
P10.07	The running time of step 2		0.0 s	○
P10.08	Multi-step speed 3		0.0%	○
P10.09	The running time of step 3		0.0 s	○
P10.10	Multi-step speed 4		0.0%	○
P10.11	The running time of step 4		0.0 s	○
P10.12	Multi-step speed 5		0.0%	○
P10.13	The running time of step 5		0.0 s	○
P10.14	Multi-step speed 6		0.0%	○
P10.15	The running time of step 6		0.0 s	○
P10.16	Multi-step speed 7		0.0%	○
P10.17	The running time of step 7		0.0 s	○
P10.18	Multi-step speed 8	0.0%	○	
P10.19	The running time of step 8	0.0 s	○	
P10.20	Multi-step speed 9	0.0%	○	
P10.21	The running time of step 9	0.0 s	○	
P10.22	Multi-step speed 10	0.0%	○	
P10.23	The running time of step 10	0.0 s	○	
P10.24	Multi-step speed 11	0.0%	○	
P10.25	The running time of step 11	0.0 s	○	
P10.26	Multi-step speed 12	0.0%	○	
P10.27	The running time of step 12	0.0 s	○	

If multi-step speed operation is selected, multi-step speeds are in the range of $-f_{max}$ – f_{max} and it can be set continuously. The start/stop of multi-step running is also determined by [P00.01](#).

Goodrive35 series VFDs can set 16 stages speed, selected by the combination of multi-step terminals 1–4 (select the setting by S terminals, the corresponding function codes are [P05.01](#)–[P05.09](#)), corresponding to the speed 1 to speed 15.

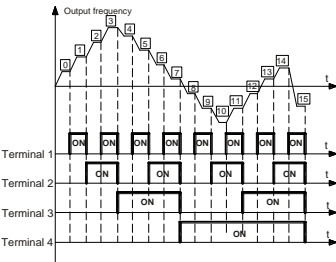

When terminal 1, 2, 3, 4=OFF, the frequency input mode is selected via [P00.06](#) or [P00.07](#). When terminal 1, 2, 3, and 4 are not off, they run at multi-step which takes precedence of keypad, analog value, high-speed pulse, PLC, and communication frequency input.

The relation between terminal 1, 2, 3, 4 and

Function code	Name	Description	Default	Modify																																																																																																									
P10.28	Multi-step speed 13	multi-step speed is as following:	0.0%	○																																																																																																									
P10.29	Running time of step 13	Terminal 1 OFF ON OFF ON OFF ON OFF ON Terminal 2 OFF OFF ON ON OFF OFF ON ON	0.0 s	○																																																																																																									
P10.30	Multi-step speed 14	Terminal 3 OFF OFF OFF OFF ON ON ON ON Terminal 4 OFF OFF OFF OFF OFF OFF OFF OFF	0.0%	○																																																																																																									
P10.31	Running time of step 14	Step 0 1 2 3 4 5 6 7	0.0 s	○																																																																																																									
P10.32	Multi-step speed 15	Terminal 1 OFF ON OFF ON OFF ON OFF ON Terminal 2 OFF OFF ON ON OFF OFF ON ON	0.0%	○																																																																																																									
P10.33	Running time of step 15	Terminal 3 OFF OFF OFF OFF ON ON ON ON Terminal 4 ON ON ON ON ON ON ON ON Step 8 9 10 11 12 13 14 15	0.0 s	○																																																																																																									
P10.34	Simple PLC 0-7 step ACC/DEC time	Below is the detailed instruction:	0x0000	○																																																																																																									
P10.35	Simple PLC 8-15 step ACC/DEC time	<table border="1"> <thead> <tr> <th>Function code</th> <th>Binary bit</th> <th>Step</th> <th>ACC/DEC 0</th> <th>ACC/DEC 1</th> <th>ACC/DEC 2</th> <th>ACC/DEC 3</th> </tr> </thead> <tbody> <tr> <td rowspan="8">P10.34</td> <td>BIT1 BIT0</td> <td>0</td> <td>00</td> <td>01</td> <td>10</td> <td>11</td> </tr> <tr> <td>BIT3 BIT2</td> <td>1</td> <td>00</td> <td>01</td> <td>10</td> <td>11</td> </tr> <tr> <td>BIT5 BIT4</td> <td>2</td> <td>00</td> <td>01</td> <td>10</td> <td>11</td> </tr> <tr> <td>BIT7 BIT6</td> <td>3</td> <td>00</td> <td>01</td> <td>10</td> <td>11</td> </tr> <tr> <td>BIT9 BIT8</td> <td>4</td> <td>00</td> <td>01</td> <td>10</td> <td>11</td> </tr> <tr> <td>BIT11 BIT10</td> <td>5</td> <td>00</td> <td>01</td> <td>10</td> <td>11</td> </tr> <tr> <td>BIT13 BIT12</td> <td>6</td> <td>00</td> <td>01</td> <td>10</td> <td>11</td> </tr> <tr> <td>BIT15 BIT14</td> <td>7</td> <td>00</td> <td>01</td> <td>10</td> <td>11</td> </tr> <tr> <td rowspan="8">P10.35</td> <td>BIT1 BIT0</td> <td>8</td> <td>00</td> <td>01</td> <td>10</td> <td>11</td> </tr> <tr> <td>BIT3 BIT2</td> <td>9</td> <td>00</td> <td>01</td> <td>10</td> <td>11</td> </tr> <tr> <td>BIT5 BIT4</td> <td>10</td> <td>00</td> <td>01</td> <td>10</td> <td>11</td> </tr> <tr> <td>BIT7 BIT6</td> <td>11</td> <td>00</td> <td>01</td> <td>10</td> <td>11</td> </tr> <tr> <td>BIT9 BIT8</td> <td>12</td> <td>00</td> <td>01</td> <td>10</td> <td>11</td> </tr> <tr> <td>BIT11 BIT10</td> <td>13</td> <td>00</td> <td>01</td> <td>10</td> <td>11</td> </tr> <tr> <td>BIT13 BIT12</td> <td>14</td> <td>00</td> <td>01</td> <td>10</td> <td>11</td> </tr> <tr> <td>BIT15 BIT14</td> <td>15</td> <td>00</td> <td>01</td> <td>10</td> <td>11</td> </tr> </tbody> </table>	Function code	Binary bit	Step	ACC/DEC 0	ACC/DEC 1	ACC/DEC 2	ACC/DEC 3	P10.34	BIT1 BIT0	0	00	01	10	11	BIT3 BIT2	1	00	01	10	11	BIT5 BIT4	2	00	01	10	11	BIT7 BIT6	3	00	01	10	11	BIT9 BIT8	4	00	01	10	11	BIT11 BIT10	5	00	01	10	11	BIT13 BIT12	6	00	01	10	11	BIT15 BIT14	7	00	01	10	11	P10.35	BIT1 BIT0	8	00	01	10	11	BIT3 BIT2	9	00	01	10	11	BIT5 BIT4	10	00	01	10	11	BIT7 BIT6	11	00	01	10	11	BIT9 BIT8	12	00	01	10	11	BIT11 BIT10	13	00	01	10	11	BIT13 BIT12	14	00	01	10	11	BIT15 BIT14	15	00	01	10	11	0x0000	○
		Function code	Binary bit	Step	ACC/DEC 0	ACC/DEC 1	ACC/DEC 2	ACC/DEC 3																																																																																																					
P10.34	BIT1 BIT0	0	00	01	10	11																																																																																																							
	BIT3 BIT2	1	00	01	10	11																																																																																																							
	BIT5 BIT4	2	00	01	10	11																																																																																																							
	BIT7 BIT6	3	00	01	10	11																																																																																																							
	BIT9 BIT8	4	00	01	10	11																																																																																																							
	BIT11 BIT10	5	00	01	10	11																																																																																																							
	BIT13 BIT12	6	00	01	10	11																																																																																																							
	BIT15 BIT14	7	00	01	10	11																																																																																																							
P10.35	BIT1 BIT0	8	00	01	10	11																																																																																																							
	BIT3 BIT2	9	00	01	10	11																																																																																																							
	BIT5 BIT4	10	00	01	10	11																																																																																																							
	BIT7 BIT6	11	00	01	10	11																																																																																																							
	BIT9 BIT8	12	00	01	10	11																																																																																																							
	BIT11 BIT10	13	00	01	10	11																																																																																																							
	BIT13 BIT12	14	00	01	10	11																																																																																																							
	BIT15 BIT14	15	00	01	10	11																																																																																																							
<p>After users select the corresponding ACC/DEC time, the combining 16 binary bit can be changed into hexadecimal bit, and then set the</p>																																																																																																													

Function code	Name	Description	Default	Modify
		corresponding function codes. ACC/DEC time 1 is set by P00.11 and P00.12 ; ACC/DEC time 2 is set by P08.00 and P08.01 ; ACC/DEC time 3 is set by P08.02 and P08.03 ; ACC/DEC time 4 is set by P08.04 and P08.05. Setting range: 0x0000–0xFFFF		
P10.36	PLC restart	0: Restart from the first step; stop during running (cause by the stop command, fault or power loss), run from the first stage after restart. 1: Continue to run from the stop frequency; stop during running (cause by stop command and fault), the VFD will record the running time automatically, enter into the stage after restart and keep the remaining running at the setting frequency.	0	☉
P10.37	Multi-step time unit	0: Seconds; the running time of all steps is counted by second 1: Minutes; the running time of all steps is counted by minute	0	☉

P11 Group Protective parameters

Function code	Name	Description	Default	Modify
P11.00	Phase loss protection	0x00–0x11 LED ones: 0: Input phase loss protection disable 1: Input phase loss protection enable LED tens: 0: Output phase loss protection disable 1: Output phase loss protection enable Note: The default value is 0x10 for models below 2.2 kW	11	○
P11.01	Frequency-decreasing at sudden power loss	0: Enable 1: Disable	0	○
P11.02	Frequency decreasing ratio at sudden power loss	Setting range: 0.00 Hz/s– P00.03 (max. output frequency) After the power loss of the grid, the bus voltage	10.00 Hz/s	○

Function code	Name	Description	Default	Modify						
		<p>drops to the sudden frequency-decreasing point, the VFD begin to decrease the running frequency at P11.02, to make the VFD generate power again. The returning power can maintain the bus voltage to ensure a normal running of the VFD until the recovery of power.</p> <table border="1"> <tr> <td>Voltage degree</td> <td>380 V</td> <td>660 V</td> </tr> <tr> <td>Frequency-decreasing threshold</td> <td>460 V</td> <td>800 V</td> </tr> </table> <p>Note:</p> <ol style="list-style-type: none"> 1. Adjust the parameter properly to avoid the stopping caused by VFD protection during the switching of the grid. 2. Prohibition of input phase loss protection can enable this function. 	Voltage degree	380 V	660 V	Frequency-decreasing threshold	460 V	800 V		
Voltage degree	380 V	660 V								
Frequency-decreasing threshold	460 V	800 V								
P11.03	Overvoltage stall protection	<p>0: Disable 1: Enable</p>	0	<input type="radio"/>						
P11.04	Voltage protection of overvoltage stall	120–150% (standard bus voltage) (380 V)	136%	<input type="radio"/>						
		120–150% (standard bus voltage) (660 V)	120%							
P11.05	Current limit action selection	<p>The actual increasing ratio of motor speed is lower than the ratio of output frequency because of the big load during ACC running. It is necessary to take measures to avoid overcurrent fault and the VFD trips.</p> <p>Ones: current limit setting 0: Invalid 1: Valid</p>	1	<input checked="" type="radio"/>						

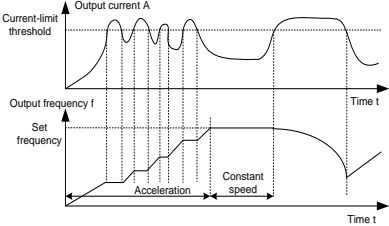
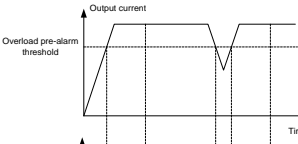
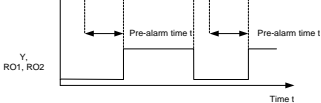
Function code	Name	Description	Default	Modify
P11.06	Automatic current limit	During the running of the VFD, it will detect the output current and compare it with the limit level defined in P11.06 . If it exceeds the level, the VFD will run at stable frequency in ACC running, or the VFD will derate to run during the constant running.	160.0 %	☉
P11.07	Frequency-decreasing ratio during current limit	<p>If it exceeds the level continuously, the output frequency will keep on decreasing to the lower limit. If the output current is detected to be lower than the limit level, the VFD will accelerate to run.</p>  <p>Setting range of P11.06: 50.0–200.0% (corresponding to the rated output current of the VFD) Setting range of P11.07: 0.00–50.00 Hz/s</p>	10.00 Hz/s	☉
P11.08	Overload pre-alarm of motor/VFD	The output current of the VFD or the motor is above P11.09 and the lasting time is beyond P11.10 , overload pre-alarm will be output.	0x000	○
P11.09	Overload pre-alarm detection		150%	○
P11.10	Overload pre-alarm detection time	 <p>Setting range of P11.08: Enable and define the overload pre-alarm of the VFD and the motor. Setting range: 0x000–0x131</p>	1.0 s	○

Function code	Name	Description	Default	Modify
		<p>LED ones:</p> <p>0: Overload/underload pre-alarm for the motor, relative to the rated current of the motor</p> <p>1: Overload/underload pre-alarm for the VFD, relative to the rated output current of the VFD</p> <p>LED tens:</p> <p>0: The VFD continues to work after an overload/underload pre-alarm is generated.</p> <p>1: The VFD continues to work after an underload pre-alarm is generated, and stops after an overload fault is reported.</p> <p>2: The VFD continues to work after an overload pre-alarm is generated, and stops after an underload fault is reported.</p> <p>3: The VFD stops after an overload/underload fault is reported.</p> <p>LED hundreds:</p> <p>0: Detection all the time</p> <p>1: Detection in constant-speed running</p> <p>Setting range of P11.09: P11.11–200% (relative value is determined by the ones place of P11.08)</p> <p>Setting range of P11.10: 0.1–3600.0s</p>		
P11.11	Underload pre-alarm detection	If the VFD current or the output current is lower than P11.11 , and its lasting time is beyond P11.12 , the VFD will output underload pre-alarm signal.	50%	<input type="radio"/>
P11.12	Underload pre-alarm detection time	Setting range of P11.11 : 0– P11.09 (relative value is determined by the ones place of P11.08) Setting range of P11.12 : 0.1–3600.0s	1.0 s	<input type="radio"/>
P11.13	Output terminal action during fault	<p>Select the action of fault output terminals on undervoltage and fault reset.</p> <p>0x00–0x11</p> <p>LED ones:</p> <p>0: Action under fault undervoltage</p> <p>1: No action under fault undervoltage</p> <p>LED tens:</p> <p>0: Action during the automatic reset</p> <p>1: No action during the automatic reset</p>	0x00	<input type="radio"/>

Function code	Name	Description	Default	Modify
P11.14	Speed deviation detection	0.0–50.0% Set the speed deviation detection time	10.0%	●
P11.15	Speed deviation detection time	<p>This parameter is used to see the speed deviation detection time.</p> <p>Note: Speed deviation protection will be invalid if P11.15 is set to 0.0.</p> <p>Setting range: 0.0–10.0s</p>	1.0 s	○
P11.16	Open loop vector and VF 0 Hz output	0: Invalid 1: Valid; ensure rated output torque when voltage drop	0	○

P12 Group Motor 2 parameters

Function code	Name	Description	Default	Modify	
P12.00	Motor type 2	0: AM 1: SM Note: Switch the current motor by the switching channel of P08.31 .	0	◎	
P12.01	Rated power of AM 2	0.1–3000.0 kW	Depend on model In order to ensure the controlling performance, set the P12.01–P12.05 according to the name plate of the AM. Goodrive35 series VFDs provide the	◎	
P12.02	Rated frequency of AM 2	0.01 Hz– P00.03 (max. output frequency)		50.00 Hz	◎
P12.03	Rated speed of AM 2	1–36000 rpm		Depend on model	◎
P12.04	Rated voltage of AM 2	0–1200 V		Depend on model	◎

Function code	Name	Description		Default	Modify
P12.05	Rated current of AM 2	0.8–6000.0 A	<p>function of parameter autotuning. Correct parameter autotuning comes from the correct setting of the motor name plate.</p> <p>In order to ensure the controlling performance, please configure the motor according to the standard principles, if the gap between the motor and the standard one is huge, the features of the VFD will decrease.</p> <p>Note: Reset the rated power of the motor (P12.01), and initialize the motor parameter of P12.02–P12.05.</p>	Depend on model	☉
P12.06	Stator resistor of AM 2	0.001–65.535 Ω	<p>After finish the motor parameter autotuning, the set value of P12.06–P12.10 will renew automatically.</p> <p>These parameters are basic parameters controlled by vectors which directly impact the features.</p> <p>Note: Users cannot modify the parameters freely.</p>	Depend on model	○
P12.07	Rotor resistor of AM 2	0.001–65.535 Ω		Depend on model	○
P12.08	Leakage inductance of AM 2	0.1–6553.5 mH		Depend on model	○
P12.09	Mutual inductance of AM 2	0.1–6553.5 mH		Depend on model	○
P12.10	Non-load current of AM 2	0.1–6553.5 A		Depend on model	○

Function code	Name	Description		Default	Modify
P12.11	Magnetic saturation coefficient 1 for iron core of AM2	0.0–100.0%		85.0%	○
P12.12	Magnetic saturation coefficient 2 for iron core of AM2	0.0–100.0%		75.0%	○
P12.13	Magnetic saturation coefficient 3 for iron core of AM2	0.0–100.0%		68.0%	○
P12.14	Magnetic saturation coefficient 4 for iron core of AM2	0.0–100.0%		40.0%	○
P12.15	Rated power of SM 2	0.1–3000.0 kW	Set the parameter of the controlled AM. In order to ensure the performance, set the P12.15–P12.19 according to the name plate of the AM. Goodrive35 series VFDs provide the function of parameter autotuning. Correct parameter autotuning comes from the correct setting of the motor name plate. In order to ensure the controlling performance, please configure the motor according to the standard principles, if the gap between the	Depend on model	⊙
P12.16	Rated frequency of SM 2	0.01 Hz– P00.03 (max. output frequency)		50.00 Hz	⊙
P12.17	Number of poles pairs for SM 2	1–128		2	⊙
P12.18	Rated voltage of SM 2	0–1200 V		Depend on model	⊙
P12.19	Rated current of SM 2	0.8–6000.0 A		Depend on model	⊙

Function code	Name	Description		Default	Modify
			motor and the standard one is huge, the features of the VFD will decrease. Note: Reset the rated power of the motor (P12.15), and initialize the motor parameter of P12.16– P12.19.		
P12.20	Stator resistor of SM 2	0.001–65.535 Ω	After finish the motor parameter autotuning, the set value of P12.20–P12.22 will renew automatically. These parameters are basic parameters controlled by vectors which directly impact the features. When P00.15=1, the set value of P12.23 can be updated through autotuning automatically, and there is no need to change the value of P12.23; when P00.15=2, the set value of P12.23 cannot be updated through autotuning, please account and update the value of P12.23. Note: Users cannot modify the parameters freely.	Depend on model	<input type="radio"/>
P12.21	Direct axis inductance of SM 2	0.01–655.35 mH		Depend on model	<input type="radio"/>
P12.22	Quadrature axis inductance of SM 2	0.01–655.35 mH			
P12.23	Back EMF constant of SM 2	When P00.15=2, the set value of P12.23 cannot be updated by autotuning, please count according to the following method. The counter-electromotive force constant can be counted according to the parameters on the name plate of the motor. There are three ways to count: 1. If the name plate designate the counter-electromotive force constant Ke, then: $E = (Ke * n_N * 2\pi) / 60$ 2. If the name plate designate the counter-electromotive force constant E'		320	<input type="radio"/>

Function code	Name	Description	Default	Modify
		<p>(V/1000r/min), then: $E = E^* n_N / 1000$ 3. If the name plate does not designate the above parameters, then: $E = P / \sqrt{3} * I$ In the above formulas: n_N is the rated rotation speed, P is the rated power and I is the rated current. Setting range: 0–10000</p>		
P12.24	Initial pole position of SM 2 (reserved)	0–FFFFH (reserved)	0x0000	●
P12.25	Identification current of SM 2 (reserved)	0%–50% (the rated current of the motor) (reserved)	10%	●
P12.26	Motor 2 overload protection	0: No protection 1: Common motor (with low speed compensation) 2: Variable-frequency motor (without low speed compensation)	2	◎
P12.27	Motor 2 overload protection coefficient	<p>Motor overload multiple $M = I_{out} / (I_n \times K)$ I_n is the rated current of the motor, I_{out} is the output current of the VFD and K is the motor overload protection coefficient. The smaller K is, the greater M is, and the more likely protection is implemented. When $M=116\%$, protection is performed after motor overload lasts for 1 hour; when $M=150\%$, protection is performed after motor overload lasts for 12 minutes; when $M=180\%$, protection is performed after motor overload lasts for 5 minutes; when $M=200\%$, protection is performed after motor overload lasts for 60 seconds; and when $M \geq 400\%$, protection is performed immediately.</p>	100.0 %	○

Function code	Name	Description	Default	Modify
		<p>Setting range: 20.0%–120.0%</p>		
P12.28	Reserved			
P12.29	Parameter display of motor 2	<p>0: Display according to the motor type: only the parameters relative to the current motor type are displayed for the convenient for the customers in this mode.</p> <p>1: All parameters are displayed: all parameters are displayed in this mode.</p>	0	<input type="radio"/>

P13 Group SM control

Function code	Name	Description	Default	Modify
P13.00	Reduction coefficient of source current	0.0–100.0% (rated current of the motor)	80.0%	<input checked="" type="radio"/>
P13.01	Original pole test mode	<p>0: No test</p> <p>1: High-frequency superposition (reserved)</p> <p>2: Pulse superposition (reserved)</p>	0	<input checked="" type="radio"/>
P13.02	Source current 1	<p>Source current is the positioning current of the magnetic pole position. Source current 1 is valid under the frequency point of current shifting. Increasing the value can raise the starting torque.</p> <p>Setting range: 0.0%–100.0% (rated current of the motor)</p>	20.0%	<input type="radio"/>
P13.03	Source current 2	<p>Source current is directional current of the magnetic pole position. Source current 2 is valid under the frequency point of current shifting. There is no need to modify the value generally.</p> <p>Setting range: 0.0%–100.0% (rated current of motor)</p>	10.0%	<input type="radio"/>

Function code	Name	Description	Default	Modify
P13.04	Shift frequency of source current	0.0%–80.0% (max frequency)	20.0%	○
P13.05	Reserved			
P13.06	High-frequency superposing voltage	0.0–300.0% (rated voltage of the motor)	100.0 %	◎
P13.07	Control parameter 0	0.0–400.0%	0.0%	○
P13.08	Control parameter 1	0x0000–0xFFFF	0x0000	○
P13.09	Control parameter 2	0.00–655.35	2.00	○
P13.10	Initial angle compensation of synchronous machine	0.0–359.9	0.0	○
P13.11	Maladjustment detection time	Adjust the response of anti-maladjustment. Bigger load inertia may increase the value, but the response will be slower. Setting range: 0.0–10.0 s	0.5 s	○
P13.12	High-frequency compensation coefficient of synchronous machine	When the motor speed is faster than the rated speed, the parameter is valid, if vibration occurs to the motor, please adjust the parameter. Setting range: 0.0–100.0%	0.0%	○
P13.13	Braking current of short-circuit	When P01.00 =0 during the starting of the VFD, set P13.14 to a non-zero value to enter the short circuit	0.0%	○
P13.14	Braking retention time before starting	braking. When the running frequency is lower than P01.09 during the stopping of the VFD, set 13.15 to a non-zero value to enter into stopping short circuited	0.0 s	○
P13.15	The braking retention time when stopping	braking and then carry out the DC braking at the time set by P01.12 (refer to the instruction of P01.09–P01.12) . Setting range of P13.13 : 0.0–150.0% (corresponding to the rated output current of the VFD) Setting range of P13.14 : 0.0–50.0s Setting range of P13.15 : 0.0–50.0s	0.0 s	○

P14 Group Serial communication

Function code	Name	Description	Default	Modify
P14.00	Local communication address	<p>The setting range: 1–247</p> <p>When the master is writing the frame, the communication address of the slave is set to 0; the address is the communication address. All slaves on the Modbus fieldbus can receive the frame, but the slave doesn't answer.</p> <p>The communication of the drive is unique in the communication net. This is the fundamental for the point to point communication between the upper monitor and the VFD.</p> <p>Note: The address of the slave cannot set to 0.</p>	1	<input type="radio"/>
P14.01	Communication baud ratio	<p>Set the digital transmission speed between the upper monitor and the VFD.</p> <p>0: 1200 BPS 1: 2400 BPS 2: 4800 BPS 3: 9600 BPS 4: 19200 BPS 5: 38400 BPS 6: 57600 BPS 7: 115200 BPS</p> <p>Note: The baud rate between the upper PC and the VFD must be the same. Otherwise, the communication is not applied. The bigger the baud rate, the quicker the communication speed.</p>	4	<input type="radio"/>
P14.02	Digital bit check	<p>The data format between the upper monitor and the VFD must be the same. Otherwise, the communication is not applied.</p> <p>0: No check (N, 8, 1) for RTU 1: Even check (E, 8, 1) for RTU 2: Odd check (O, 8, 1) for RTU 3: No check (N, 8, 2) for RTU 4: Even check (E, 8, 2) for RTU 5: Odd check (O, 8, 2) for RTU</p>	1	<input type="radio"/>
P14.03	Answer delay	<p>0–200 ms</p> <p>The interval time when the VFD receives the data</p>	5 ms	<input type="radio"/>

Function code	Name	Description	Default	Modify
		and sent it to the upper monitor. If the answer delay is shorter than the system processing time, then the answer delay time is the system processing time, if the answer delay is longer than the system processing time, then after the system deal with the data, waits until achieving the answer delay time to send the data to the upper monitor		
P14.04	Fault time of communication overtime	0.0 (invalid), 0.1–60.0 s When the function code is set as 0.0, the communication overtime parameter is invalid When the function code is set as non-zero, if the interval time between two communications exceeds the communication overtime, the system will report "485 communication faults" (CE). Generally, set it as invalid; set the parameter in the continuous communication to monitor the communication state.	0.0 s	○
P14.05	Transmission fault processing	0: Alarm and stop freely 1: No alarm and continue to run 2: No alarm and stop according to the stop mode (only under the communication control) 3: No alarm and stop according to the stop mode (under all control modes)	0	○
P14.06	Communication processing	0x000–0x111 LED ones: 0: Write with response: the VFD will respond to all reading and writing commands of the upper monitor. 1: Write without response: the VFD only responds to the reading command rather than the writing command of the drive, thus improving communication efficiency. LED tens: 0: Communication encrypting invalid 1: Communication encrypting valid LED hundreds: 0: Function code parameters changed by communication are stored during Poff; 1: Function codes are stored based on the MSB of	0x000	○

Function code	Name	Description	Default	Modify
		communication address (1 or 0), which means the function codes will be stored during Pof if the MSB is 1 or stored immediately if the MSB is 0.		

P15 Group PROFIBUS/CANopen function

Function code	Name	Description	Default	Modify
P15.00	Module type	0: PROFIBUS; 1: CANopen Select communication protocol	0	☉
P15.01	Module address	0–127 This function code is used to designate the address of the VFD. Note: 0 is the broadcast address, when set it as broadcast address, only receive the radio command of the upper monitor other than answering the upper monitor. After the function code has been modified, it takes effect only after you power off to restart.	2	☉
P15.02	PZD2 receiving	0: Invalid	0	○
P15.03	PZD3 receiving	1: Setting frequency (0–Fmax (unit: 0.01 Hz))	0	○
P15.04	PZD4 receiving	2: PID reference, range (0–1000, 1000 corresponds to 100.0%)	0	○
P15.05	PZD5 receiving	3: PID feedback, range (0–1000, 1000 corresponds to 100.0%)	0	○
P15.06	PZD6 receiving	4: Torque setting (-3000–3000, 1000 corresponds to 100.0% the rated current of the motor)	0	○
P15.07	PZD7 receiving	5: Upper frequency of forward rotation (0–Fmax unit: 0.01 Hz)	0	○
P15.08	PZD8 receiving	6: Upper frequency of reverse rotation (0–Fmax (unit: 0.01 Hz))	0	○
P15.09	PZD9 receiving	7: Electromotion torque upper limit (0–3000, 1000 corresponds to 100.0% of the rated current of the motor)	0	○
P15.10	PZD10 receiving	8: Braking torque upper limit (0–2000, 1000 corresponds to 100.0% of the rated current of the motor)	0	○
P15.11	PZD11 receiving	9: Virtual input terminals command	0	○
P15.12	PZD12 receiving			

Function code	Name	Description	Default	Modify
		Range: 0x000–0x1FF 10: Virtual output terminals command Range: 0x00–0x0F 11: Voltage setting value (special for V/F separation) (0–1000, 1000 corresponds to 100.0% the rated voltage of the motor) 12: AO output set value 1 (-1000→+1000, 1000 corresponds to 100.0%) 13: AO output set value 2 (-1000→+1000, 1000 corresponds to 100.0%) 14: MSB of position reference (signed digit) 15: LSB of position reference (unsigned digit) 16: MSB of position feedback (signed digit) 17: LSB of position feedback (unsigned digit) 18: Position feedback setting flag (Position feedback can be set only after you set this flag to 1 first and then set it to 0.) 19–20: Reserved		
P15.13	PZD2 sending	0: Invalid	0	○
P15.14	PZD3 sending	1: Running frequency (*100, Hz)	0	○
P15.15	PZD4 sending	2: Setting frequency (*100, Hz)	0	○
P15.16	PZD5 sending	3: Bus voltage (*10, V)	0	○
P15.17	PZD6 sending	4: Output voltage (*1, V)	0	○
P15.18	PZD7 sending	5: Output current (*10, A)	0	○
P15.19	PZD8 sending	6: Output torque actual value (*10, %)	0	○
P15.20	PZD9 sending	7: Output power actual value (*10, %)	0	○
P15.21	PZD10 sending	8: Running rotating speed (*1, RPM)	0	○
P15.22	PZD11 sending	9: Running linear speed (*1, m/s)	0	○
P15.23	PZD12 sending	10: Ramp reference frequency 11: Fault code 12: AI1 value (*100, V) 13: AI2 value (*100, V) 14: AI3 value (*100, V) 15: PULSE frequency value (*100, kHz) 16: Terminals input state 17: Terminals output state 18: PID given (*100, %) 19: PID feedback (*100, %)	0	○

Function code	Name	Description	Default	Modify
		20: Motor rated torque 21: MSB of position reference (signed digit) 22: LSB of position reference (unsigned digit) 23: MSB of position feedback (signed digit) 24: LSB of position feedback (unsigned digit) 25: State words		
P15.24	Temporary variable 1 for PZD sending	0-65535	0	○
P15.25	Fault time of DP communication overtime	0.0 (invalid), 0.1-60.0s When this function code is set as 0.0, this function is invalid. When the function code is set as nonzero value, if the internal time between two communication exceeds the communication overtime, the system will report "PROFIBUS communication fault" (E-DP).	0.0 s	○
P15.26	Fault time of CANopen communication overtime	0.0 (invalid),0.1-60.0 s When this function code is set as 0.0, this function is invalid When the function code is set as nonzero value, if the internal time between two communication exceeds the communication overtime, the system will report "CANopen communication fault" (E-CAN)	0.0 s	
P15.27	CANopen baud rate	Set the data transmission rate. 0: 1000 k 1: 800 k 2: 500 k 3: 250 k 4: 125 k 5: 100 k 6: 50 k 7: 20 k Note: After the function code has been modified, it takes effect only after you power off to restart.	0	●

P16 Group Ethernet function

Function code	Name	Description	Default	Modify
P16.00	Speed setting of Ethernet communication	0: Self-adapting 1: 100M full duplex 2: 100M semiduplex 3: 10M full duplex 4: 10M semiduplex The function code is used to set the Ethernet communication speed. Note: After the function code has been modified, it takes effect only after you power off to restart.	0	☉
P16.01	IP address 1	0-255 Set the IP address of Ethernet communication The format of IP address: P16.09 , P16.10 , P16.11 , P16.12 For example: IP address is 192.168.0.1. Note: After function codes have been modified, they take effect only after you power off to restart.	192	☉
P16.02	IP address 2		168	☉
P16.03	IP address 3		0	☉
P16.04	IP address 4		1	☉
P16.05	Subnet mask 1	0-255 Set the subnet mask of Ethernet communication. The format of IP subnet mask: P16.13 , P16.14 , P16.15 , P16.16 . For example: The mask is 255.255.255.0. Note: After function codes have been modified, they take effect only after you power off to restart.	255	☉
P16.06	Subnet mask 2		255	☉
P16.07	Subnet mask 3		255	☉
P16.08	Subnet mask 4		0	☉
P16.09	Gateway 1	0-255 Set the gateway of Ethernet communication	192	☉
P16.10	Gateway 2		168	☉
P16.11	Gateway 3		1	☉
P16.12	Gateway 4		1	☉

P17 Group Status viewing

Function code	Name	Description	Default	Modify
P17.00	Setting frequency	Display current set frequency of the VFD Range: 0.00 Hz- P00.03	0.00 Hz	●
P17.01	Output frequency	Display current output frequency of the VFD Range: 0.00 Hz- P00.03	0.00 Hz	●

Function code	Name	Description	Default	Modify																				
P17.02	Ramp reference frequency	Display current ramp reference frequency of the VFD Range: 0.00 Hz– P00.03	0.00 Hz	●																				
P17.03	Output voltage	Display current output voltage of the VFD Range: 0–1200 V	0 V	●																				
P17.04	Output current	Display present output current of the VFD Range: 0.0–5000.0 A	0.0 A	●																				
P17.05	Motor speed	Display the rotation speed of the motor. Range: 0–65535 RPM	0 RPM	●																				
P17.06	Torque current	Display present torque current of the VFD Range: -3000.0–3000.0 A	0.0 A	●																				
P17.07	Exciting current	Display present exciting current of the VFD Range: -3000.0–3000.0 A	0.0 A	●																				
P17.08	Motor power	Display present power of the motor. Setting range: -300.0%–300.0% (rated power of the motor)	0.0%	●																				
P17.09	Output torque	Display the current output torque of the VFD; 100% relative to rated torque of the motor. During forward running, the positive value is the motoring state while the negative value is generating state. During reverse running, the positive value is the generating state while the negative value is the motoring state. Range: -250.0–250.0%	0.0%	●																				
P17.10	Evaluated motor frequency	Evaluate the motor rotor frequency on closed-loop vector Range: 0.00– P00.03	0.00 Hz	●																				
P17.11	DC bus voltage	Display current DC bus voltage of the VFD Range: 0.0–2000.0 V	0.0 V	●																				
P17.12	Digital input terminals state	Display present digital input terminals state of the VFD <table border="1" style="margin-left: auto; margin-right: auto;"> <tr> <td></td> <td>BIT8</td> <td>BIT7</td> <td>BIT6</td> <td>BIT5</td> </tr> <tr> <td></td> <td>HDI</td> <td>S8</td> <td>S7</td> <td>S6</td> </tr> <tr> <td>BIT4</td> <td>BIT3</td> <td>BIT2</td> <td>BIT1</td> <td>BIT0</td> </tr> <tr> <td>S5</td> <td>S4</td> <td>S3</td> <td>S2</td> <td>S1</td> </tr> </table> Range: 0000–01FF		BIT8	BIT7	BIT6	BIT5		HDI	S8	S7	S6	BIT4	BIT3	BIT2	BIT1	BIT0	S5	S4	S3	S2	S1	0	●
	BIT8	BIT7	BIT6	BIT5																				
	HDI	S8	S7	S6																				
BIT4	BIT3	BIT2	BIT1	BIT0																				
S5	S4	S3	S2	S1																				

Function code	Name	Description	Default	Modify								
P17.13	Digital output terminals state	Display present digital output terminals state of the VFD <table border="1" style="margin-left: 20px;"> <tr> <td style="text-align: center;">BIT3</td> <td style="text-align: center;">BIT2</td> <td style="text-align: center;">BIT1</td> <td style="text-align: center;">BIT0</td> </tr> <tr> <td style="text-align: center;">RO2</td> <td style="text-align: center;">RO1</td> <td style="text-align: center;">HDO</td> <td style="text-align: center;">Y</td> </tr> </table> Range: 0000–000F	BIT3	BIT2	BIT1	BIT0	RO2	RO1	HDO	Y	0	●
BIT3	BIT2	BIT1	BIT0									
RO2	RO1	HDO	Y									
P17.14	Digital adjustment	Display the adjustment via the VFD keypad Range : 0.00 Hz– P00.03	0.00 Hz	●								
P17.15	Torque reference	Display the torque given, the percentage to the current rated torque of the motor. Setting range: -300.0%–300.0% (rated current of the motor)	0.0%	●								
P17.16	AI1 adjustment voltage	Display AI1 adjustment voltage. 0.00–10.00 V	0.00 V	●								
P17.17	AI2 adjustment voltage	Display AI2 adjustment voltage. 0.00–10.00 V	0.00 V	●								
P17.18	AI3 adjustment voltage	Display AI3 adjustment voltage. 0.00–10.00 V	0.00 V	●								
P17.19	AI1 input voltage	Display analog AI1 input signal Range: 0.00–10.00 V	0.00 V	●								
P17.20	AI2 input voltage	Display analog AI2 input signal Range: 0.00–10.00 V	0.00 V	●								
P17.21	AI3 input voltage	Display analog AI3 input signal Range: -10.00–10.00 V	0.00 V	●								
P17.22	HDI input frequency	Display HDI input frequency Range: 0.00–50.00 kHz	0.00 kHz	●								
P17.23	PID reference	Display PID reference value. Range: -100.0–100.0%	0.0%	●								
P17.24	PID feedback	Display PID feedback value Range: -100.0–100.0%	0.0%	●								
P17.25	Power factor of the motor	Display the current power factor of the motor. Range: -1.00–1.00	0.00	●								
P17.26	Current running time	Display the current running time of the VFD. Range: 0–65535 min	0 min	●								
P17.27	Simple PLC and the current step of the multi-step speed	Display simple PLC and the current stage of the multi-step speed Range: 0–15	0	●								

Function code	Name	Description	Default	Modify
P17.28	ASR controller output	This parameter is used to display the output value of the automatic speed regulator (ASR). The value is relative to the rated torque of the motor. Range: -300.0%→+300.0% (the rated torque of the motor)	0.0%	●
P17.29	initial identification angle of synchronous machine	Display initial identification angle of synchronous machine Range: 0.0–359.9	0.0	●
P17.30	Phase compensation of SM	Display SM phase compensation Range: -180.0–180.0	0.0	●
P17.31	Reserved			
P17.32	Reserved			
P17.33	Exciting current reference	Display the exciting current reference in the vector control mode Range: -3000.0–3000.0 A	0.0 A	●
P17.34	Torque current reference	Display the torque current reference in the vector control mode Range: -3000.0–3000.0 A	0.0 A	●
P17.35	AC current	Display the value of inlet current in AC side Range: 0.0–5000.0 A	0.0 A	●
P17.36	Output torque	Display the output torque value. During forward running, the positive value is the motoring state while the negative value is generating state. During reverse running, the positive value is the generating state while the negative value is the motoring state. Range : -3000.0Nm–3000.0 Nm	0.0 Nm	●
P17.37	PID deviation	-100.0%–100.0%	0.0%	●
P17.38	PID output	-200.00%–200.00%	0.00%	●
P17.39	Wrong download of parameters	0.00–29.00	0.00	●

P18 Group States viewing 2

Function code	Name	Description	Default	Modify
P18.00	Actual frequency detected by the encoder	P18.00 is the actual frequency of the encoder. If the motor rotates forward, the value is positive; if the motor rotates reverse, the value is negative. Range: -3276.8–3276.7 Hz	0.0 Hz	●
P18.01	Position counting of the encoder	Position counting of the encoder, 4 times of the frequency Range: 0–65535	0	●
P18.02	Pulse Z counting of the encoder	Pulse Z counting of the encoder Range: 0–65535	0	●
P18.03	MSB of the position reference	The value will be cleared if stopping. Range: 0–30000	0	●
P18.04	LSB of the position reference	The value will be cleared if stopping. Range: 0–65535	0	●
P18.05	MSB of the position feedback	The value will be cleared if stopping. Range: 0–30000	0	●
P18.06	LSB of the position feedback	The value will be cleared if stopping. Range: 0–65535	0	●
P18.07	Position deviation	The deviation between reference position and actual operation position. Range: -32768–32767	0	●
P18.08	Position reference	The reference position of pulse Z when spindle stops. Range: 0–65535	0	●
P18.09	Current position of the spindle	Current position setting when spindle stops. Range: 0–359.99	0.00	●
P18.10	Current position at spindle orientation	Current position of the spindle at the oriented spindle stop. Range: 0–65535	0	●
P18.11	Reverse of pulse Z	Display of pulse Z direction. When the spindle stops, the stopping position of forward and reverse rotation may have a deviation of a few pulses. After adjusting the direction of pulse Z or the AB phase of encoder, the stopping position will be same. 0: Forward 1: Reverse	0	●
P18.12	pulse Z angle	Reserved Range: 0–359.99	0.00	●

Function code	Name	Description	Default	Modify
P18.13	Fault times of pulse Z	Reserved Range: 0–65535	0	●
P18.14	MSB of encoder pulse counting	After power on, the value will be counted continuously. Range: 0–65535	0	●
P18.15	LSB of encoder pulse counting	After power on, the value will be counted continuously. Range: 0–65535	0	●
P18.17	Pulse command frequency	Pulse command (terminals A2 and B2) is converted into setting frequency and keeps valid in pulse position mode and pulse speed mode Range: 0.0–400.0 Hz	0.0 Hz	●
P18.18	Pulse command forward feedback	Pulse command (terminals A2 and B2) is converted into setting frequency and keeps valid in pulse position mode and pulse speed mode Range: 0.0–400.0 Hz	0.0 Hz	●
P18.19	Position regulator output	The position regulator output frequency in position control. Range: 0.00–400.00 Hz	0.00 Hz	●
P18.20	Rotary transformer counting	Rotary transformer counting, 0–1024. Range: 0–65535	0	●
P18.21	Rotary transformer angle	The magnetic position angle from the rotary transformer. Range: 0.00–359.99	0.00	●
P18.22	Pole angle	Current magnetic position. Range: 0.00–359.99	0.00	●
P18.23	State control word 3	Range: 0–65535	0	●
P18.24	MSB of pulse reference counting	After power on, the value will be counted continuously. Range: 0–65535	0	●
P18.25	LSB of pulse reference counting	After power on, the value will be counted continuously. Range: 0–65535	0	●

Function code	Name	Description	Default	Modify
P18.26	Inertia compensation torque	Inertia compensation torque Range: -100.0%–100.0%	0.0%	●
P18.27	Friction compensation torque	The torque value of friction compensation. Range: -100.0%–100.0%	0.0%	●
P18.28	Spindle drive ratio	The drive ratio of encoder installation shaft to spindle when the spindle stops. Range: 0.000–65.535	0.000	●
P18.30	Reserved			

P20 Group Encoder

Function code	Name	Description	Default	Modify
P20.00	Encoder type	0: Incremental encoder 1: ABZUVW encoder 2: Resolver encoder 3: Sin/cos encoder without CD signal 4: Sin/cos encoder with CD signal	0	◎
P20.01	Pulse number	Pulse number when the encoder rotates a circle. Range: 0–60000	1024	◎
P20.02	Encoder direction	Setting range: 0x000–0x111 Ones: Encoder AB direction 0: Forward 1: Reverse When encoder offline fault (ENC1o) or encoder reverse fault (ENC1d) is reported, adjust this function code to change the AB pulse direction, removing the need of re-adjusting the wiring of AB pulse. Tens: Pulse Z direction 0: Forward 1; Reverse No setting required Hundreds: Direction of magnetic pole signal 0: Forward 1: Reverse	0x000	◎

Function code	Name	Description	Default	Modify
		Perform rotary autotuning on magnetic pole position (P20.11 =1 or 3), if autotuning is succeeded, the magnetic pole signal direction will be set automatically.		
P20.03	Encoder disconnection fault reporting threshold time	Detection time of encoder offline fault. Range: 0.0–100.0 s	1.0 s	<input type="radio"/>
P20.04	Encoder reverse running fault reporting threshold time	Detection time of encoder reverse fault. Range: 0.0–100.0 s	0.8 s	<input type="radio"/>
P20.05	Number of encoder detection filtering times	Setting range: 0x00–0x99 Ones place: Number of low-speed filtering times; corresponding to $2^{(0-9)} \times 125 \mu\text{s}$ Tens place: Number of high-speed filtering times; corresponding to $2^{(0-9)} \times 125 \mu\text{s}$	0x33	<input type="radio"/>
P20.06	Rotating speed ratio of the motor to encoder	When the encoder is not mounted on the shaft of the motor and the drive ratio is not 1, you need to set this parameter. Setting range: 0.001–65.535	1.000	<input type="radio"/>
P20.07	Control parameters of SM	Setting range: 0x0000–0xFFFF Generally, you do not need to modify this parameter. Bit0: Enabling pulse Z calibration Bit1: Enabling encoder angle calibration Bit2: Enabling SVC speed measurement Bit3: Setting resolver speed measurement mode Bit4: Setting pulse Z capture mode Bit12: Deleting pulse Z arrival signal when the machine is stopped	0x0003	<input type="radio"/>
P20.08	Enabling pulse Z disconnection detection	ENC1Z indicates pulse Z disconnection fault. When the spindle orientation function is used or an incremental encoder is used for the synchronous machine, you can enable pulse Z detection to prevent inaccurate orientation or synchronous machine control failure caused due to pulse Z loss.	0	<input type="radio"/>

Function code	Name	Description	Default	Modify
		0: Disabled 1: Enabled		
P20.09	Initial angle of pulse Z	Electrical degree between pulse Z of the encoder and the magnetic pole position of the motor. Setting range: 0.00–359.99	0.00	○
P20.10	Pole initial angle	Electrical degree between the position of the encoder and the magnetic pole position of the motor. Setting range: 0.00–359.99	0.00	○
P20.11	Autotuning of magnetic pole initial angle	Setting range: 0–3 0: No operation 1: Rotary autotuning (no load) 2: Static autotuning (fit for resolver and sin/cos encoder) 3: Rotary autotuning (loaded) After setting the value to 1 or 2, the keypad will display "-RUN-", then press "RUN" to begin the autotuning until the keypad display "-END-". The identified initial angle is saved in P20.09 and P20.10 . The pole initial angle obtained from rotary autotuning 1 is more accurate. Generally it is necessary to de-couple the motor or lighten the motor load for rotary autotuning.	0	◎
P20.12	Encoder signal filter width	Range: 0.0–20.0μs	0.5 μs	○
P20.13	Speed optimization enabling	0: Disabled 1: Enabled	0–1	◎

P21 Group Position control

Function code	Name	Description	Default	Modify
P21.00	Positioning mode	Setting range: 0x00–0x21 Ones: Control mode setting, setting the position control mode in closed-loop vector control. 0: Speed control		

Function code	Name	Description	Default	Modify
		1: Position control Tens: Position command source 0: Pulse string, adopting terminal pulse signals A2 and B2 to implement positioning control 1: Digital position. Positioning through P21.17 and the positioning modes can be set through P21.16 2: Photoelectric switch positioning. After the terminal receives the signal (set S8 to 43), the stopping positioning begins and the stopping distance is set through P21.17 . Hundreds: Reserved Thousands: Servo mode Bit0: Position deviation mode 0: Unbiased 1: Biased Bit1: Servo enabled 0: Disabled (Terminal enabled) 1: Enabled Under the pulse string positioning mode or the spindle positioning mode, Servo enable signal is valid, the VFD will run into the servo mode, if there is no servo enable signal, the VFD needs to receive the forward or reverse run command to perform the servo operation mode. Bit2: Speed exchange position mode 0: First stop and the switch 1: Direct switching		
P21.01	Pulse command	Setting range: 0x0000–0x3133 Pulse command in pulse position mode Ones: pulse mode 0: A/B quadrature pulse, A is forward to B 1: A: PULSE; B: SIGN 2: A: Positive PULSE 3: A: Negative PULSE Tens: Pulse direction Bit0: Direction setting 0: Forward 1: Reverse	0x0000	⊙

Function code	Name	Description	Default	Modify
		Bit1: Pulse direction determined by the operation direction 0: Disabled 1: Enabled Hundreds: Pulse and direction selection 0: No frequency multiplication 1: Frequency multiplication Thousands: Pulse control Bit0: Pulse filtering selection 0: Inertial filter 1: Moving average filtering Bit1: Overspeed suppression 0: No suppression 1: Suppression		
P21.02	APR gain 1	Two automatic position regulator (APR) gains are provided. You can switch between these two gains through the switching mode set in P21.04 . When the spindle orientation function is used, the gains are switched automatically, regardless of the setting of P21.04 . P21.03 is used for dynamic running, and P21.02 is used for maintaining the locked state. Setting range: 0.0–400.0	20.0	<input type="radio"/>
P21.03	APR gain 2		30.0	<input type="radio"/>
P21.04	APR gain switching mode	This parameter is used to set the APR gain switching mode. To use torque command-based switching, you need to set P21.05 ; and to use speed command-based switching, you need to set P21.06 . 1: Torque command 2: Speed command 3–5: Reserved	0	<input type="radio"/>
P21.05	Position gain torque shifting	Setting range: 0.0–100.0% (rated torque of the motor)	10.0%	<input type="radio"/>
P21.06	Position gain speed shifting	Setting range: 0.0–100.0% (rated torque of the motor)	10.0%	<input type="radio"/>
P21.07	Smooth filter coefficient of gain shifting	Smooth filter coefficient of position gain shifting. Range: 0–15	5	<input type="radio"/>

Function code	Name	Description	Default	Modify
P21.08	Output of the position controller	Output limit of the position controller. If the limit value is 0, the controller is invalid for position control, but valid for speed control. Range: 0.0–100.0% (P00.03)	20.0%	<input type="radio"/>
P21.09	Positioning finished range	The positioning finished signal of output position when the position deviation is below P21.09 and the lasting time is above P21.10 . Range: 0–1000	10	<input type="radio"/>
P21.10	Detection time of the positioning	Range: 0.0–1000.0 ms	10.0 ms	<input type="radio"/>
P21.11	Numerator of the position command ratio	Used to change the corresponding relationship of adjusting position commands and actual operation displacement. Range: 1–65535	1000	<input type="radio"/>
P21.12	Denominator of the position command ratio	Range: 1–65535	1000	<input type="radio"/>
P21.13	Position feedforward gain	Position gain for pulse string-based position reference. Generally, you do not need to modify this parameter. Range: 0.00–120.00%	100.00 %	<input type="radio"/>
P21.14	Position forward feedback filter time coefficient	Position forward feedback filter time coefficient when the position of pulse string is given. Range: 0.0–3200.0 ms	3.0 ms	<input type="radio"/>
P21.15	Position command filter time coefficient	Filter time coefficient of position reference for pulse string. Range: 0.0–3200.0 ms	0.0 ms	<input checked="" type="radio"/>
P21.16	Digital positioning mode	0x0000–0xFFFF Bit 0: Positioning mode 0: Relative position 1: Absolute position (origin point) Bit1: Cyclic positioning setting. You can enable positioning through a terminal (function no. 55) or choose automatic cyclic positioning. Terminals support only the enabling of continuous positioning, and automatic cyclic positioning can be set to cyclic positioning or reciprocating positioning through Bit2	0x0000	<input type="radio"/>

Function code	Name	Description	Default	Modify
		<p>of P21.16.</p> <p>0: Terminal-based cyclic positioning 1: Automatic cyclic positioning</p> <p>Bit 2: Cyclic mode, valid in the automatic cyclic positioning mode 0: Continuous 1: Reciprocating</p> <p>Bit 3: P21.17 digital setting mode. Users can select incremental or position type. The incremental type indicates that P21.17 needs to be conducted again after each positioning is enabled. When the position reference bit command is enabled, the displacement is set through P21.17. When P21.17 is changed, new position is be positioned automatically.</p> <p>0: Incremental mode 1: Position mode</p> <p>Bit 4: Origin searching mode. This function is reserved. 0: Searching for the origin only for once 1: Searching for the origin in every time of running</p> <p>Bit 5: Origin calibration mode. This function is reserved. 0: Calibration in real time 1: One-time calibration</p> <p>Bit 6: Positioning completion signal setting. You can set the positioning completion signal in the pulse or electrical level form. The positioning completion signal is valid in the positioning completion signal holding time set in P21.25. 0: Valid in the positioning completion signal holding time (P21.25) 1: Always valid</p> <p>Bit 7: First positioning setting. You can set whether the first positioning is performed when a running command is received. If no, the first positioning is performed only after the positioning enabling terminal or automatic cyclic positioning is enabled. 0: Disabled</p>		

Function code	Name	Description	Default	Modify
		1: Enabled Bit 8: Positioning enabling signal setting (for terminal-based cyclic positioning). In the pulse form, after positioning is completed or in the first positioning, the jump edge of the positioning enabling terminal needs to be detected for performing positioning. In the electrical level mode, after positioning is completed or in the first positioning, positioning is performed after it is detected that the positioning enabling terminal is switched on. 0: Pulse signal 1: Electrical level signal Bit 9: Position source 0: Set in P21.17 1: PROFIBUS/CANopen setting		
P21.17	Location figures reference	Set the position place of digital setting Actual position = $\text{P21.17} * \text{P21.11} / \text{P21.12}$ 0–65535	0	<input type="radio"/>
P21.18	Positioning speed setting	Positioning speed setting 0: P21.19 digital setting 1: AI1 setting 2: AI2 setting 3: AI3 setting 4: HDI setting	0	<input type="radio"/>
P21.19	Digital setting of positioning speed	Select the positioning speed Range: 0.1–100.0% of the max frequency	20.0%	<input type="radio"/>
P21.20	Positioning ACC time	Set the ACC/DEC time during the positioning Position ACC time is the interval time accelerating	3.00s	<input type="radio"/>
P21.21	Positioning DEC time	Position DEC time is the interval time decelerating from 0 Hz to P00.03 from P00.03 to 0 Hz Setting range of P21.20 : 0.01–300.00s Setting range of P21.21 : 0.01–300.00s	3.00s	<input type="radio"/>
P21.22	Hold time of positioning arrival	Set the hold waiting time after arriving to the target position Range: 0.000–60.000 s	0.100s	<input type="radio"/>

Function code	Name	Description	Default	Modify
P21.23	Origin search speed	Reserved. 0.00–50.00 Hz	2.00 Hz	<input type="radio"/>
P21.24	Origin position offset	Reserved. Range: 0–64000	0	<input type="radio"/>
P21.25	Hold time of positioning complete signal	The hold time of positioning complete signal and also valid to the positioning complete signal of spindle stopping Range: 0.000–60.000 s	0.200 s	<input type="radio"/>
P21.26	Pulse superposition value	P21.26 : -9999–32767 P21.27 : 0–3000.0/ ms The functions are valid when P00.06 =12 or P21.00 =1.	0	<input type="radio"/>
P21.27	Pulse superposition rate	1. Input terminal function 50 (pulse superposition enabling) If the terminal rising edge is detected, the pulse setting is increased by the value specified by P21.26 . Pulses are compensated to the pulse setting channel at the rate specified by P21.27 . Input terminal function 31 (pulse ascending) If the terminal is valid, pulses are superposed to the pulse setting channel at the rate specified by P21.27 . Note: P05.11 may impose a slight impact on the actual superposition value. Example: P21.27 = 1.0/ms P5.05 = 31 If terminal S5 input signal lasts 0.5s, the actual superposed pulse count is 500. Input terminal function 32 (pulse descending) The timing sequence of this function is similar to that of the previous one, but the superposed pulse count in this function is a negative number. Note: The pulses are superposed to A2 and B2 of the pulse setting channel. The functions such as pulse filtering and electronic gear are still valid for superposed pulses.	8.0/ ms	<input type="radio"/>

Function code	Name	Description	Default	Modify
		4. Output terminal function 28 (pulse superposing) The output terminal is valid during pulse superposing, but it is invalid after pulse superposing.		
P21.28	ACC/DEC time after pulse prohibition	Range: 0.00–300.00 s	0.50 s	<input type="radio"/>
P21.29	Filter time constant of speed feedforward	When P00.06 =12 or P00.07 =12, it is the filter time constant detected by pulse string Range: 0–3200.0 ms	10.0 ms	<input type="radio"/>
P21.30	Rigid tapping	0–0x31 Ones: Enabling selection 0: Terminal enabling (terminal function 58) 1: Internal enabling Tens: Analog port selection 0: AI3 1: AI1 2: AI2	0x00	<input checked="" type="radio"/>
P21.31	Electronic gear 2	Range: 1–65535 It can be selected through terminal function 28.	1000	<input type="radio"/>
P21.32	Maximum frequency of rigid tapping	Range: 0.0–400.00 Hz	50.00 Hz	<input type="radio"/>
P21.34	Pulse setting signal filter width	Range: 0.0–20.0 us	0.5 us	<input type="radio"/>

P22 Group Spindle positioning

Function code	Name	Description	Default	Modify
P22.00	Spindle position mode	Setting range: 0x0000–0xFFFF Bit0: Enable spindle positioning. This parameter is used to enable the spindle orientation function. 0: Disabled 1: Enabled Bit1: Spindle positioning reference point. You can set pulse Z of the encoder or a photoelectric switch (setting S6/S7 to function #43) to function as the	0x0000	<input type="radio"/>

Function code	Name	Description	Default	Modify
		<p>reference point for spindle orientation.</p> <p>0: Pulse Z input 1: S6/S7/S8 terminal input</p> <p>Bit2: Searching reference point setting. You can set whether to search for the reference point in every time of running. 0: Searching only for once 1: Searching in every time of running</p> <p>Bit3: Enabling reference point calibration 0: Disabled 1: Enabled</p> <p>Bit4: Positioning mode 1, setting the direction for spindle orientation 0: Position at the set direction 1: Position at the nearest direction</p> <p>Bit5: Position mode 2. When Bit4 is set to 0, you can set forward or reverse orientation. 0: Forward position 1: Reverse position</p> <p>Bit6: Zero-point returning form 0: Electrical level form. The positioning commands (zero-point returning and indexing) can be executed only when a running command is received. 1: Pulse form. The positioning commands (zero-point returning and indexing) can be executed without a running command. If a running command is received, the operation mode is automatically switched to speed control mode.</p> <p>Bit7: Reference point calibration mode, setting whether to perform position calibration every time when the reference point is passed. 0: Calibrated when the reference point is passed for the first time 1: Calibrated in real time</p> <p>Bit8: Reserved</p> <p>Bit9: Positioning completion signal setting</p>		

Function code	Name	Description	Default	Modify
		0: Electrical level signal 1: Pulse signal Bit10: Pulse Z signal source 0: From the motor 1: From the spindle Bit 11–15: Reserved		
P22.01	Spindle orientation speed	Speed for searching for the orientation start position point. After the orientation start position point is found, the operation mode is switched to the position control mode and orientation is performed. Range: 0.00–100.00 Hz	10.00 Hz	○
P22.02	Spindle orientation DEC time	DEC time in spindle orientation. It indicates the time the VFD takes to decelerate from the max. output frequency (P00.03) to 0 Hz. Setting range: 0.0–100.0s	3.0 s	○
P22.03	Spindle zero-point position 0	You can set 4 spindle zero-point positions through terminals (functions #46 and 47). Range: 0–39999	0	○
P22.04	Spindle zero-point position 1	Range: 0–39999	0	○
P22.05	Spindle zero-point position 2	Range: 0–39999	0	○
P22.06	Spindle zero-point position 3	Range: 0–39999	0	○
P22.07	Spindle indexing angle 1	You can set 7 spindle indexing angles through terminals (function #48, 49, and 50). Range: 0.00–359.99	15.00	○
P22.08	Spindle indexing angle 2	Range: 0.00–359.99	30.00	○
P22.09	Spindle indexing angle 3	Range: 0.00–359.99	45.00	○
P22.10	Spindle indexing angle 4	Range: 0.00–359.99	60.00	○
P22.11	Spindle indexing angle 5	Range: 0.00–359.99	90.00	○

Function code	Name	Description	Default	Modify
P22.12	Spindle indexing angle 6	Range: 0.00–359.99	120.00	<input type="radio"/>
P22.13	Spindle indexing angle 7	Range: 0.00–359.99	180.00	<input type="radio"/>
P22.14	Spindle drive ratio	This parameter is used to set the deceleration ratio of the spindle to shaft where the encoder is mounted. Range: 0.000–30.000	1.000	<input type="radio"/>
P22.15	Spindle zero-point communication setting	P22.15 is used to set the zero-point offset of the spindle. If you set P22.03 as the zero point of the spindle, the final zero point of the spindle is P22.03 plus P22.15 . Range: 0–39999	0	<input type="radio"/>

7 Basic operation instruction

7.1 What this chapter contains

This chapter describes the internal function mode of the VFD in details.

	<ul style="list-style-type: none"> ◇ Check all terminals are connected properly and tightly. ◇ Check that the power of the motor corresponds to that of the VFD.
---	--

7.2 First powering on

Check before powering on

Please check according to the installation list in 1.4.

Original powering operation

Check to ensure there is no mistake in wiring and power supply, switch on the air switch of the AC power supply on the input side of the VFD to power on the VFD. 8.8.8.8.8 will be displayed on the keypad, and the contactor closes normally. When the character on the nixie tube changes to the set frequency, the VFD has finished the initialization and it is in the stand-by state.

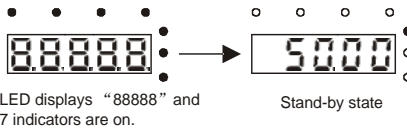

Below diagram shows the first operation: (take motor 1 as the example)

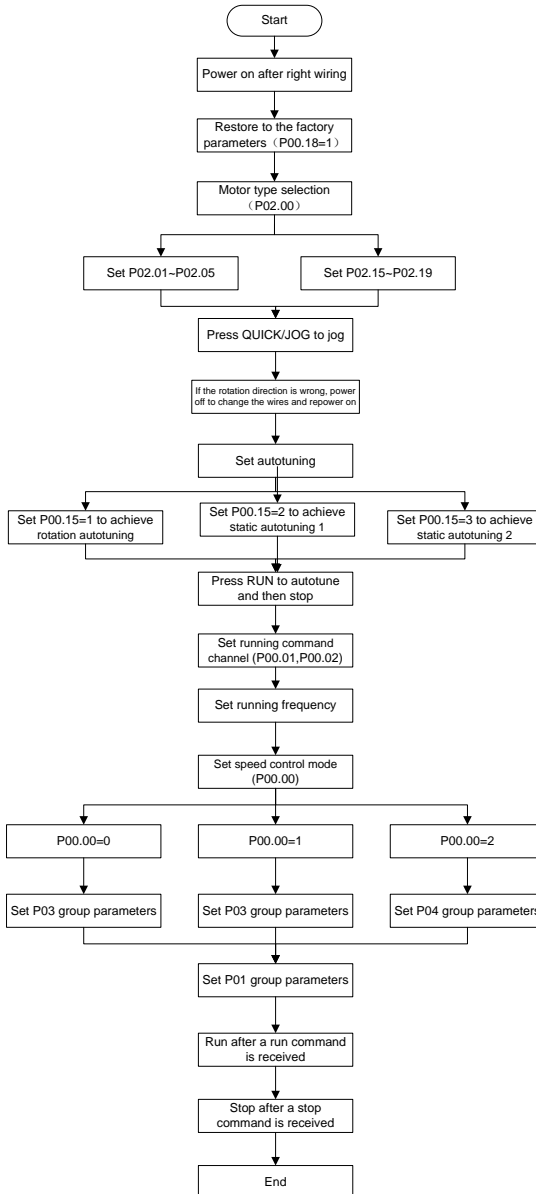

Note: If fault occurs, please do as the "Fault Tracking". Estimate the fault reason and settle the issue.

Besides P00.01 and P00.02, terminal command setting can also be used to set running command channel.

Current running command channel P00.01	Multi-function terminal 36 Switch to keypad	Multi-function terminal 37 Switch to terminal	Multi-function terminal 38 Switch to communication
Keypad running command channel	/	Terminal running command channel	Communication running command channel
Terminal running command channel	Keypad running command channel	/	Communication running command channel
Communication running command channel	Keypad running command channel	Terminal running command channel	/

Note: "/" means the multi-function terminal is invalid on the current given channel.

Relative parameters table:

Function code	Name	Description	Default
P00.00	Speed control mode	0: Sensorless vector control mode 0 (apply to AM and SM) 1: Sensorless vector control mode 1 (applying to AM) 2: SVPWM control 3: Closed-loop vector control	2
P00.01	Run command channel	0: Keypad running command 1: Terminal running command channel ("LOCAL/REMOT" flickering) 2: Communication running command channel ("LOCAL/REMOT" on);	0
P00.02	Communication running commands	0: Modbus communication channel 1: PROFIBUS/CANopen communication channel 2: Ethernet communication channel 3: Reserved	0
P00.18	Function restore parameter	0: No operation 1: Restore the default value 2: Cancel the fault record	0
P00.15	Motor parameter autotuning	0: No operation 1: Rotation autotuning	0

Function code	Name	Description	Default
		2: Static autotuning 1 (autotune totally) 3: Static autotuning 2 (autotune part parameters)	
P02.00	Motor type 1	0: Asynchronous motor 1: Synchronous motor	1
P02.01	Rated power of asynchronous motor 1	0.1–3000.0 kW	Depend on model
P02.02	Rated frequency of asynchronous motor 1	0.01 Hz–P00.03 (max. output frequency)	50.00 Hz
P02.03	Rated speed of asynchronous motor 1	1–36000 rpm	Depend on model
P02.04	Rated voltage of asynchronous motor 1	0–1200 V	Depend on model
P02.05	Rated current of asynchronous motor 1	0.8–6000.0 A	Depend on model
P02.15	Rated power of synchronous motor 1	0.1–3000.0 kW	Depend on model
P02.16	Rated frequency of synchronous motor 1	0.01 Hz–P00.03 (max. output frequency)	50.00 Hz
P02.17	Number of poles pairs for synchronous motor 1	1–128	2
P02.18	Rated voltage of synchronous motor 1	0–1200 V	Depend on model
P02.19	Rated current of synchronous motor 1	0.8–6000.0 A	Depend on model
P05.01–P05.09	Multi-function digital input terminals (S1–S8,HDI) function selection	36: Shift the command to keypad 37: Shift the command to terminals 38: Shift the command to communication	
P07.01	Parameter copy	The function code determines the manner of parameters copy. 0: No operation 1: Upload the local function parameter to the keypad 2: Download the keypad function parameter to local address (including the motor parameters) 3: Download the keypad function parameter to	0

Function code	Name	Description	Default
		local address (excluding the motor parameter of P02 and P12 group) 4: Download the keypad function parameters to local address (only for the motor parameter of P02 and P12 group)	
P07.02	QUICK/JOG function selection	0: No function 1: Jogging. Press QUICK/JOG to begin the jogging running. 2: Shift the display state by the shifting key. Press QUICK/JOG to shift the displayed function code from right to left. 3: Shift between forward rotations and reverse rotations. Press QUICK/JOG to shift the direction of the frequency commands. This function is only valid in the keypad commands channels. 4: Clear UP/DOWN settings. Press QUICK/JOG to clear the set value of UP/DOWN. 5: Coast to stop. Press QUICK/JOG to coast to stop. 6: Shift the given manner of running commands. Press QUICK/JOG to shift the given manner of running commands. 7: Quick commission mode (commission according to the non-factory parameter)	1

7.3 Vector control

Because asynchronous motors have the characteristics of high stage, nonlinear, strong coupling and various variables, the actual control of the asynchronous motor is very difficult. Vector control is mainly used to settle this problem with the theme of that divide the stator current vector into exciting current (the current left generating internal magnetic field of the motor) and torque current (the current left generating torque) by controlling and measuring the stator current vector according to the principles of beamed magnetic field to control the range and phase of these two hefts. This method can realize the decoupling of exciting current and torque current to adjust the high performance of asynchronous motors.

Goodrive35 series VFDs are embedded speedless sensor vector control calculation for driving both asynchronous motors and synchronous motors. Because the core calculation of vector control is

based on exact motor parameter models, the accuracy of motor parameter will impact on the performance of vector control. It is recommended to input the motor parameters and carry out autotune before vector running.

Because the vector control calculation is very complicated, high technical theory is needed for the user during internal autotune. It is recommended to use the specific function parameters in vector control with cautions.

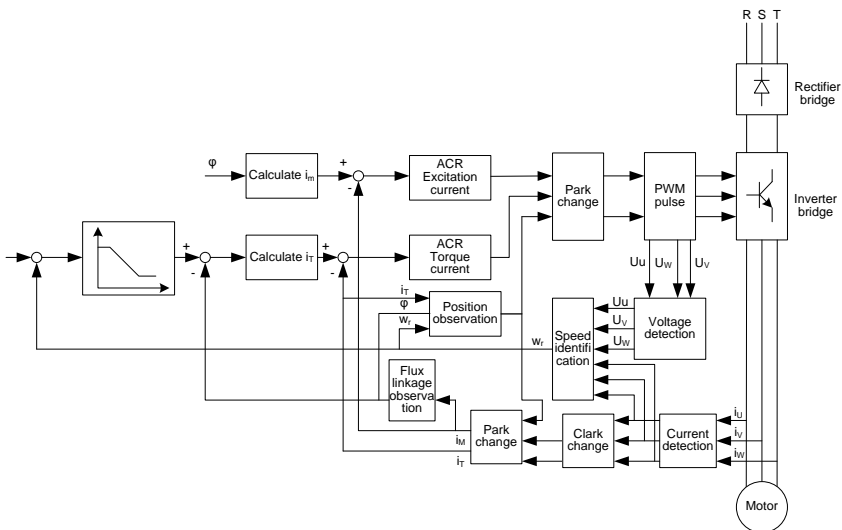

Function code	Name	Description	Default
P00.00	Speed control mode	0: SVC 1 1: SVC 2 2: SVPWM control 3: FVC	2
P00.15	Motor parameter autotuning	0: No operation 1: Rotation autotuning 2: Static autotuning 1 (autotune totally) 3: Static autotuning 2 (autotune part parameters)	0
P02.00	Motor type 1	0: Asynchronous motor 1: Synchronous motor	1
P03.00	ASR proportional gain1	0–200.0	16.0
P03.01	ASR integral time1	0.000–10.000 s	0.200 s

Function code	Name	Description	Default
P03.02	Low-point frequency for switching	0.00 Hz–P03.05	5.00 Hz
P03.03	ASR proportional gain 2	0–200.0	10.0
P03.04	ASR integral time 2	0.000–10.000 s	0.200 s
P03.05	High-point frequency for switching	P03.02–P00.03 (max. output frequency)	10.00 Hz
P03.06	ASR output filter	0–8 (corresponds to $0-2^8/10$ ms)	0
P03.07	Compensation coefficient of electromotion slip	50%–200%	100%
P03.08	Compensation coefficient of braking slip	50%–200%	100%
P03.09	ACR proportional coefficient P	0–20000	1000
P03.10	ACR integral coefficient I	0–20000	1000
P03.11	Torque setting method	0: Torque control is invalid 1: Keypad setting torque (P03.12) 2: Analog AI1 setting torque 3: Analog AI2 setting torque 4: Analog AI3 setting torque 5: Pulse frequency HDI setting torque 6: Multi-step torque setting 7: Modbus communication setting torque 8: PROFIBUS/CANopen communication setting torque (the same as above) 9: Ethernet communication setting torque (the same as above) 10: Reserved Note: Setting modes 2–10, 100% corresponds to three times of the rated current of the motor.	0
P03.12	Keypad setting torque	-300.0%–300.0% (rated motor current)	10.0%
P03.13	Torque reference filter time	0.000–10.000s	0.100 s
P03.14	Upper frequency of forward rotation in vector control	0: Keypad (P03.16) 1: AI1 2: AI2 3: AI3 4: Pulse frequency HDI setting upper-limit frequency	

Function code	Name	Description	Default
		5: Multi-step setting upper-limit frequency 6: Modbus communication setting upper-limit frequency 7: PROFIBUS/CANopen communication setting upper-limit frequency 8: Ethernet communication setting upper-limit frequency (the same as above) Note: Setting method 0–8, 100% corresponds to the maximum frequency.	
P03.15	Upper frequency of reverse rotation in vector control	0: Keypad (P03.17) 1–8: The same as P03.14	
P03.16	Keypad setting for upper frequency of forward rotation	Setting range: 0.00 Hz–P00.03 (max. output frequency)	50.00 Hz
P03.17	Keypad setting for upper frequency of reverse rotation		50.00 Hz
P03.18	Upper electromotion torque source	0: Keypad setting upper-limit frequency (P03.20) 1: AI1 2: AI2 3: AI3 4: HDI 5: Modbus communication 6: PROFIBUS/CANopen communication 7: Ethernet communication Note: Set mode 1–7, 100% corresponds to three times of the motor current.	
P03.19	Upper braking torque source	0: Keypad (P03.21) 1–7: The same as P03.18	
P03.20	Keypad setting of electromotion torque	0.0–300.0% (rated current of the motor)	180.0%
P03.21	Keypad setting of braking torque		180.0%
P03.22	Weakening coefficient in constant power zone	0.01–2.00	1.00
P03.23	Lowest weakening point in constant power zone	5%–50%	10%
P03.24	Max voltage limit	0.0–120.0%	100.0%

Function code	Name	Description	Default
P03.25	Pre-exciting time	0.000–10.000 s	0.0 s
P03.26	Weak proportional gain	0–8000	1200
P03.27	Integral gain of the flux weakening	0–8000	1200
P03.28	Control mode of the flux weakening	0x000–0x112 Ones: Control mode selection 0–2 Tens: Inductance compensation selection 0: Compensate 1: Not compensate Hundreds: High speed control mode 0: Mode 0 1: Mode 1	0x000
P03.29	Torque control mode	0x0000–0x7111 Ones: Torque command selection 0: Torque reference 1: Torque current reference Tens: Torque compensation direction at 0 speed 0: Positive 1: Negative Hundreds: ASR integral separation setting 0: Disabled 1: Enabled Thousands: Torque control word setting Bit0: Torque command filtering mode 0: Inertia filter 1: Linear ACC/DEC filtering Bit1–2: ACC/DEC time for rotating speed upper limit 0: No ACC/DEC time 1: ACC/DEC time 1 2: ACC/DEC time 2 3: ACC/DEC time 3	0x0001
P03.30	Low-speed friction torque	0–50.0% (rated torque of the motor)	0.0%
P03.31	High-speed friction torque	0–50.0% (rated torque of the motor)	0.0%
P03.32	Corresponding frequency of high-speed friction torque	1.00 Hz–400.00 Hz	50.00 Hz

7.4 SVPWM control

Goodrive35 series VFDs provide internal SVPWM control which can be used in the cases where it does not need high control accuracy. It is also recommended to use SVPWM control when one VFD drives multiple motors.

Goodrive35 series VFDs provide multiple V/F curve modes. The user can select the corresponding V/F curve to the site needs. Or they can set the corresponding V/F curve to their own needs.

Suggestions:

1. For the load of constant torque, such as the conveyor belt which runs linearly. It is properly to select linear V/F curve because it needs constant torque.
2. For the load of decreasing torque, such as fans and water pumps, it is properly to select corresponding 1.3th, 1.7th or 2th power of V/F curve because the actual torque is 2-squared or 3-squared of the rotating speed.

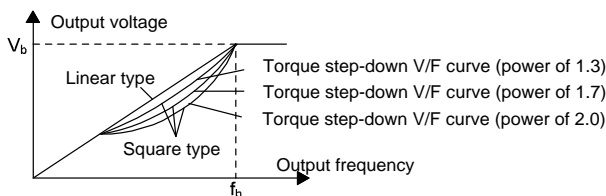

Goodrive35 series VFDs provide multi-dots V/F curve, the user can change the output V/F curve by setting the voltage and frequency of three middle dots. The whole curve is consisted of 5 dots. The starting dot is (0 Hz, 0 V), and the ending dot is (the basic frequency of the motor, the rated voltage of the motor). During the setting processing: $0 \leq f_1 \leq f_2 \leq f_3 \leq f_b$; $0 \leq V_1 \leq V_2 \leq V_3 \leq V_b$.

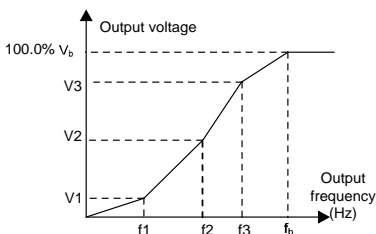

Goodrive35 series VFDs provide special function code for SVPWM control mode which can improve the performance of SVPWM control by means of setting.

1. Torque boost

Torque boost function can effectively compensate for the performance of low speed torque during SVPWM control. Automatic torque boost has been set by default to enable the VFD to adjust the torque boost value based on the actual load conditions.

Note:

The torque boost takes effect only when the frequency is under the cap frequency of the boost. If the torque boost is too big, low frequency vibration or overcurrent fault may occur to the motor. If such situation occurs, lower the torque boost value..

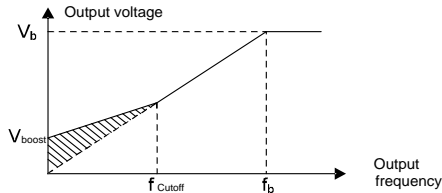
**2. Energy-saving running**

In the actual operation, the VFD can search by itself to achieve a better effect point. The VFD can work with high effect to save energy.

Note:

This function is usually used in the cases where the load is light or empty. If the load transients frequently, this function is not appropriate to be selected.

3. V/F slips compensation gain

SVPWM control belongs to the open loop mode. If the load of the motor transients suddenly, the fluctuation of the rotation speed may occur. In the cases where the high accuracy speed is needed, slip compensation gain (internal output adjustment) can be set to compensate the speed change caused by load fluctuation.

Setting range of slip compensation gain: 0–200%, of which 100% corresponds to rated slip frequency.

Note: Rated slip frequency= (rated synchronous rotation speed of the motor-rated rotation speed of the motor) *number of pole pairs/60.

4. Vibration control

Motor vibration occurs frequently when applying SVPWM control mode in the cases where high power is needed. In order to settle this problem, Goodrive35 series VFDs add two function codes which are set to control the vibration factors. The user can set the corresponding function code according to the vibration frequency.

Note: Bigger the set value, more effective is the control. If the set value is too big, overcurrent may occur to the VFD.

User-defined V/F curve (V/F separation) function

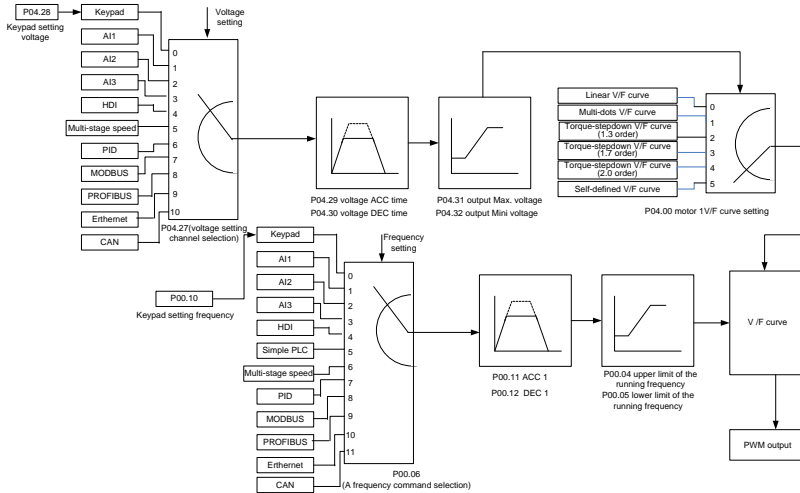

When the user selects the user-defined V/F curve function in Goodrive35 series VFDs, they can set the reference channel of voltage and frequency and the corresponding ACC/DEC time, or the two can be combined to form a real-time curve.

Note: The application of V/F curve separation can be used in many cases with various kinds of power supply of the VFD. But the users should set and adjust the parameters with caution. Incorrect parameters may cause damage to the VFD.

Function code	Name	Description	Default
P00.00	Speed control mode	0: Sensorless vector control mode 1 1: Sensorless vector control mode 2 2: SVPWM control 3: Closed-loop vector control mode	2
P00.03	Max. output frequency	P00.04–400.00 Hz	50.00 Hz
P00.04	Upper limit of running frequency	P00.05–P00.03	50.00 Hz
P00.05	Lower limit of running frequency	0.00 Hz–P00.04	0.00 Hz
P00.11	ACC time 1	0.0–3600.0 s	Depend on model
P00.12	DEC time 1	0.0–3600.0 s	Depend on model
P02.00	Motor type 1	0: Asynchronous motor 1: Synchronous motor	1

Function code	Name	Description	Default
P02.02	Rated frequency of asynchronous motor 1	0.01 Hz–P00.03 (max. output frequency)	50.00
P02.04	Rated voltage of asynchronous motor 1	0–1200 V	Depend on model
P04.00	Motor 1 V/F curve setting	0: Straight line V/F curve 1: Multi-dots V/F curve 2: Torque down V/F curve (power of 1.3) 3: Torque down V/F curve (power of 1.7) 4: Torque down V/F curve (power of 2.0) 5: Customized V/F (V/F separation)	0
P04.01	Torque boost of motor 1	0.0%: (automatic) 0.1%–10.0%	0.0%
P04.02	Torque boost close of motor 1	0.0%–50.0% (rated frequency of motor 1 frequency)	20.0%
P04.03	V/F frequency 1 of motor 1	0.00 Hz–P04.05	0.00 Hz
P04.04	V/F voltage 1 of motor 1	0.0%–110.0%	00.0%
P04.05	V/F frequency 2 of motor 1	P04.03–P04.07	00.00 Hz
P04.06	V/F voltage 2 of motor 1	0.0%–110.0%	00.0%
P04.07	V/F frequency 3 of motor 1	P04.05–P02.02 or P04.05–P02.16	00.00 Hz
P04.08	V/F voltage 3 of motor 1	0.0%–110.0%	00.0%
P04.09	V/F slip compensation gain of motor 1	0.0–200.0%	100.0%
P04.10	Vibration control factor at low frequency of motor 1	0–100	10
P04.11	Vibration control factor at high frequency of motor 1	0–100	10
P04.12	Vibration control threshold of motor 1	0.00 Hz–P00.03 (max. output frequency)	30.00 Hz
P04.13	Motor 2 V/F curve setting	0: Straight line V/F curve 1: Multi-dots V/F curve 2: Torque step-down V/F curve (power of 1.3) 3: Torque step-down V/F curve (power of 1.7) 4: Torque step-down V/F curve (power of 2.0) 5: Customized V/F (V/F separation)	0
P04.14	Torque boost of motor 2	0.0%: (automatic) 0.1%–10.0%	0.0%
P04.15	Torque boost close of motor 2	0.0%–50.0% (rated frequency of motor 1)	20.0%
P04.16	V/F frequency 1 of motor 2	0.00 Hz–P04.18	0.00 Hz

Function code	Name	Description	Default
P04.17	V/F voltage 1 of motor 2	0.0%–110.0%	00.0%
P04.18	V/F frequency 2 of motor 2	P04.16–P04.20	00.00 Hz
P04.19	V/F voltage 2 of motor 2	0.0%–110.0%	00.0%
P04.20	V/F frequency 3 of motor 2	P04.18–P12.02 (rated frequency of AM 2) or P04.18–P12.16 (rated frequency of SM 2)	00.00 Hz
P04.21	V/F voltage 3 of motor 2	0.0%–110.0%	00.0%
P04.22	V/F slip compensation gain of motor 2	0.0–200.0%	100.0%
P04.23	Vibration control factor at low frequency of motor 2	0–100	10
P04.24	Vibration control factor at high frequency of motor 2	0–100	10
P04.25	Vibration control threshold of motor 2	0.00 Hz–P00.03 (max. output frequency)	30.00 Hz
P04.26	Energy-saving operation	0: No action 1: Automatic energy-saving running	0
P04.27	Voltage setting	0: Keypad: the output voltage is determined by P04.28. 1: AI1; 2: AI2; 3: AI3; 4: HDI1; 5: Multi-step speed; 6: PID; 7: Modbus communication; 8: PROFIBUS/CANopen communication; 9: Ethernet communication (reserved) 10: Reserved	0
P04.28	Keypad setting voltage	0.0%–100.0% (rated voltage of motor)	100.0%
P04.29	Voltage increasing time	0.0–3600.0s	5.0 s
P04.30	Voltage decreasing time	0.0–3600.0s	5.0 s
P04.31	Maximum output voltage	P04.32–100.0% (rated voltage of motor)	100.0%
P04.32	Minimum output voltage	0.0%–P04.31 (rated voltage of motor)	0.0%

7.5 Torque control

Goodrive35 series VFDs support two kinds of control mode: torque control and rotation speed control. The core of rotation speed is that the whole control focuses on the stable speed and ensures the setting speed is the same as the actual running speed. The Max Load should be in the range of the

torque limit. The core of torque control is that the whole control focus on the stable torque and ensures the setting torque is the same as the actual output torque. At the same time, the output frequency is among the upper limit or the lower limit.

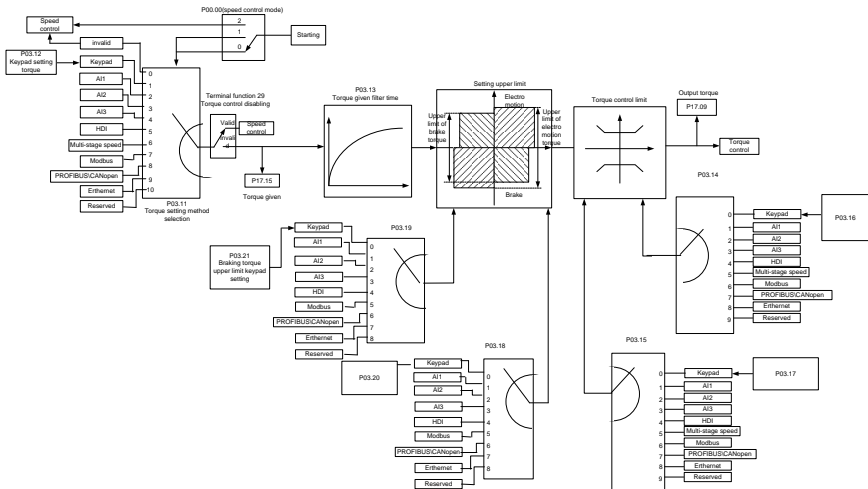



Function code	Name	Description	Default
P00.00	Speed control mode	0: Sensorless vector control mode 1: Sensorless vector control mode 2 2: SVPWM control 3: Closed-loop vector control mode	2
P03.11	Torque setting method	0: Torque control is invalid 1: Keypad setting torque (P03.11) 2: Analog AI1 setting torque (100% corresponds to three times of the rated current of the motor) 3: Analog AI2 setting torque (the same as above) 4: Analog AI3 setting torque (the same as above) 5: Pulse frequency HDI setting torque (the same as above) 6: Multi-step torque setting (the same as above) 7: Modbus communication setting torque (the	0

Function code	Name	Description	Default
		same as above) 8: PROFIBUS/CANopen communication setting torque (the same as above) 9: Ethernet communication setting torque (the same as above) 10: Reserved	
P03.12	Keypad setting torque	-300.0%–300.0% (rated current of the motor)	10.0%
P03.13	Torque reference filter time	0.000–10.000 s	0.100s
P03.14	Upper frequency of forward rotation in vector control	0: Keypad (P03.16) 1: AI1 (100% corresponds to max. frequency) 2: AI2 (the same as above) 3: AI3 (the same as above) 4: Pulse frequency HDI (the same as above) 5: Multi-step (the same as above) 6: Modbus communication (the same as above) 7: PROFIBUS/CANopen communication (the same as above) 8: Ethernet communication (the same as above)	0
P03.15	Upper frequency of reverse rotation in vector control	0: Keypad (P03.17) 1: AI1 (100% corresponds to max. frequency) 2: AI2 (the same as above) 3: AI3 (the same as above) 4: Pulse frequency HDI (the same as above) 5: Multi-step (the same as above) 6: Modbus communication (the same as above) 7: PROFIBUS/CANopen communication (the same as above) 8: Ethernet communication (the same as above)	0
P03.16	Keypad setting for upper frequency of forward rotation	0.00 Hz–P00.03 (max. output frequency)	50.00 Hz

Function code	Name	Description	Default
P03.17	Keypad setting for upper frequency of reverse rotation	0.00 Hz–P00.03 (max. output frequency)	50.00 Hz
P03.18	Upper electromotion torque source	0: Keypad setting upper-limit frequency (P03.20) 1: AI1 (100% corresponds to three times of the rated current of the motor) 2: AI2 (the same as above) 3: AI3 (the same as above) 4: HDI (the same as above) 5: Modbus communication (the same as above) 6: PROFIBUS/CANopen communication (the same as above) 7: Ethernet communication (the same as above)	0
P03.19	Upper braking torque source	0: Keypad setting upper-limit frequency (P03.21) 1: AI1 (100% corresponds to three times of the rated current of the motor) 2: AI2 (the same as above) 3: AI3 (the same as above) 4: HDI (the same as above) 5: Modbus communication (the same as above) 6: PROFIBUS/CANopen communication (the same as above) 7: Ethernet communication (the same as above)	0
P03.20	Keypad setting of electromotion torque	0.0–300.0% (rated current of the motor)	180.0%
P03.21	Keypad setting of braking torque	0.0–300.0% (rated current of the motor)	180.0%
P17.09	Output torque	-250.0–250.0%	0.0%
P17.15	Torque reference	-300.0–300.0% (rated current of the motor)	0.0%

7.6 Parameters of the motor

	<ul style="list-style-type: none"> ◇ Physical accident may occur if the motor starts up suddenly during autotune. Please check the safety of surrounding environment of the motor and the load before autotune. ◇ The power is still applied even the motor stops running during static autotune. Please do not touch the motor until the autotune is completed, otherwise there would be electric shock.
	<p>Do not carry out the rotation autotune if the motor is coupled with the load, please do not operate on the rotation autotune. Otherwise misacts or damage may occur to the VFD or the mechanical devices. When carry out autotune on the motor which is coupled with load, the motor parameter won't be counted correctly and misacts may occur. It is proper to de-couple the motor from the load during autotune when necessary.</p>

Goodrive35 series VFDs can drive both asynchronous motors and synchronous motors. And at the same time, they can support two sets of motor parameters which can shift between two motors through multi-function digital input terminal or communication.

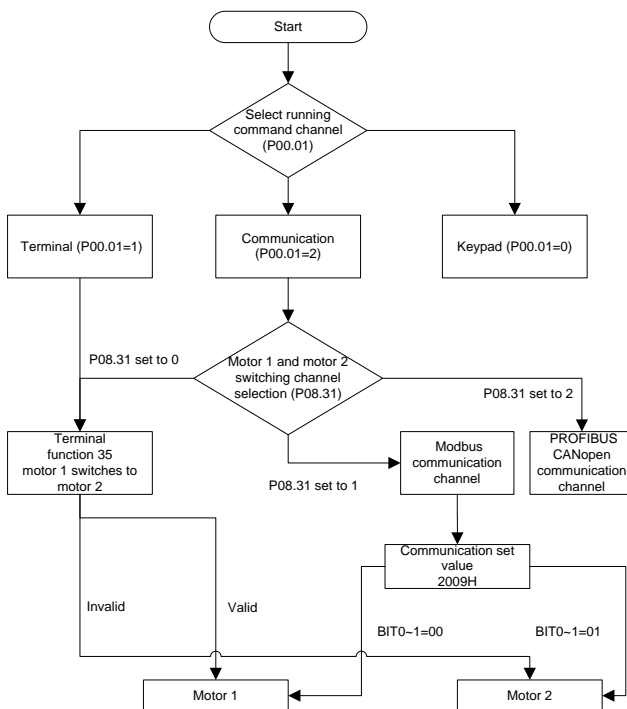

The control performance of the VFD is based on the established accurate motor model. The user has to carry out the motor autotuning before initial running (take motor 1 as an example).

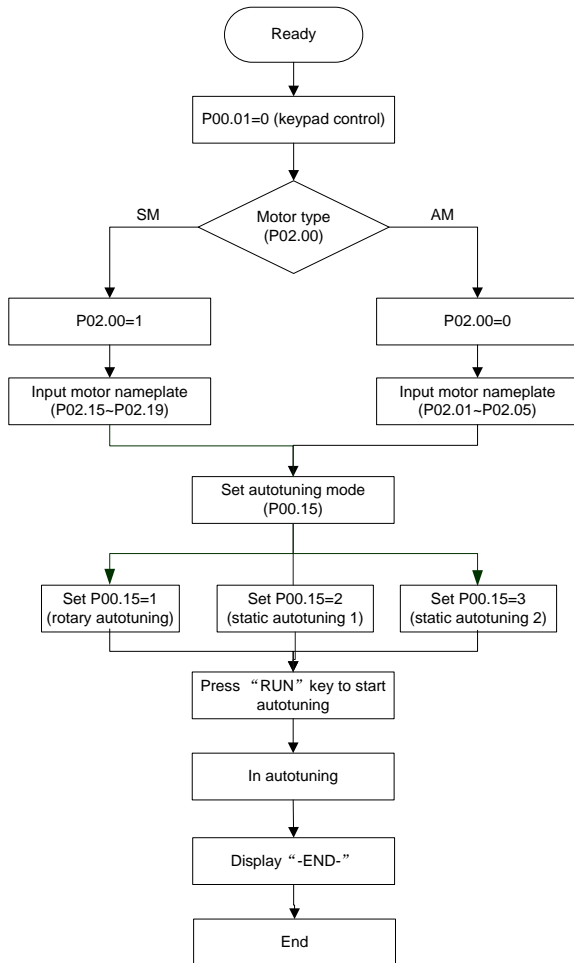

Note:

- ✧ Set the motor parameters according to the name plate of the motor.
- ✧ During the motor autotune, de-couple the motor from the load if rotation autotune is selected to make the motor is in a static and empty state, otherwise the result of autotune is incorrect. The asynchronous motors can autotune the parameters of P02.06–P02.10, while the synchronous motors can autotune the parameters of P02.20–P02.23.

3. During the motor autotune, do not to de-couple the motor form the load if static autotune is selected. Because only some parameters of the motor are involved, the control performance is not as better as the rotation autotune. The asynchronous motors can autotune the parameters of P02.06–P02.10, while the synchronous motors can autotune the parameters of P02.20–P02.22. P02.23 (synchronous motor 1 counter-electromotive force constant) can be counted to attain.

4. Motor autotune only involves the current motor. Switch the motor through P08.31 to carry out the autotune on the other motor.

Relative parameters list:

Function code	Name	Description	Default
P00.01	Run command channel	0: Keypad running command (LED off) 1: Terminal running command channel (LED flickering) 2: Communication running command channel (LED on)	0
P00.15	Motor parameter autotuning	0: No operation 1: Rotation autotuning 2: Static autotuning 1 (autotune totally) 3: Static autotuning 2 (autotune part parameters)	0
P02.00	Motor 1	0: Asynchronous motor 1: Synchronous motor	1
P02.01	Rated power of asynchronous motor 1	0.1–3000.0 kW	Depend on model
P02.02	Rated frequency of asynchronous motor 1	0.01 Hz–P00.03 (max. output frequency)	50.00 Hz
P02.03	Rated speed of asynchronous motor 1	1–36000rpm	Depend on model
P02.04	Rated voltage of asynchronous motor 1	0–1200 V	Depend on model
P02.05	Rated current of asynchronous motor 1	0.8–6000.0A	Depend on model
P02.06	Stator resistor of asynchronous motor 1	0.001–65.535Ω	Depend on model
P02.07	Rotor resistor of asynchronous motor 1	0.001–65.535Ω	Depend on model
P02.08	Leakage inductance of asynchronous motor 1	0.1–6553.5 mH	Depend on model

Function code	Name	Description	Default
P02.09	Mutual inductance of asynchronous motor 1	0.1–6553.5 mH	Depend on model
P02.10	Non-load current of asynchronous motor 1	0.1–6553.5 A	Depend on model
P02.15	Rated power of synchronous motor 1	0.1–3000.0 kW	Depend on model
P02.16	Rated frequency of synchronous motor 1	0.01 Hz–P00.03 (max. output frequency)	50.00 Hz
P02.17	Number of poles pairs for synchronous motor 1	1–128	2
P02.18	Rated voltage of synchronous motor 1	0–1200 V	Depend on model
P02.19	Rated current of synchronous motor 1	0.8–6000.0 A	Depend on model
P02.20	Stator resistor of synchronous motor 1	0.001–65.535 Ω	Depend on model
P02.21	Direct axis inductance of synchronous motor 1	0.01–655.35 mH	Depend on model
P02.22	Quadrature axis inductance of synchronous motor 1	0.01–655.35 mH	Depend on model
P02.23	Back EMF constant of synchronous motor 1	0–10000	300
P05.01–P05.09	Multi-function digital input terminals (S1–S8, HDI) function selection	35: Shift from motor 1 to motor 2	
P08.31	Motor shifting	0: Terminal shifting; 1: Modbus communication shifting 2: PROFIBUS/CANopen communication shifting	0
P12.00	Motor 2	0: Asynchronous motor 1: Synchronous motor	1
P12.01	Rated power of asynchronous motor 2	0.1–3000.0 kW	Depend on model
P12.02	Rated frequency of asynchronous motor 2	0.01 Hz–P00.03 (max. output frequency)	50.00 Hz
P12.03	Rated speed of asynchronous motor 2	1–36000 rpm	Depend on model

Function code	Name	Description	Default
P12.04	Rated voltage of asynchronous motor 2	0–1200 V	Depend on model
P12.05	Rated current of asynchronous motor 2	0.8–6000.0 A	Depend on model
P12.06	Stator resistor of asynchronous motor 2	0.001–65.535 Ω	Depend on model
P12.07	Rotor resistor of asynchronous motor 2	0.001–65.535 Ω	Depend on model
P12.08	Leakage inductance of asynchronous motor 2	0.1–6553.5 mH	Depend on model
P12.09	Mutual inductance of asynchronous motor 2	0.1–6553.5 mH	Depend on model
P12.10	Non-load current of asynchronous motor 2	0.1–6553.5 A	Depend on model
P12.15	Rated power of synchronous motor 2	0.1–3000.0 kW	Depend on model
P12.16	Rated frequency of synchronous motor 2	0.01 Hz–P00.03 (max. output frequency)	50.00 Hz
P12.17	Number of poles pairs for synchronous motor 2	1–128	2
P12.18	Rated voltage of synchronous motor 2	0–1200 V	Depend on model
P12.19	Rated current of synchronous motor 2	0.8–6000.0 A	Depend on model
P12.20	Stator resistor of synchronous motor 2	0.001–65.535 Ω	Depend on model
P12.21	Direct axis inductance of synchronous motor 2	0.01–655.35 mH	Depend on model
P12.22	Quadrature axis inductance of synchronous motor 2	0.01–655.35 mH	Depend on model
P12.23	Back EMF constant of synchronous motor 2	0–10000	300

7.7 Start and stop control

The start-up and stop control of the VFD includes three states: start after the running command during normal powering on, start after the restarting function becomes valid during normal powering on and start after the automatic fault reset.

3. The starting logic figure of starting after the automatic fault reset.

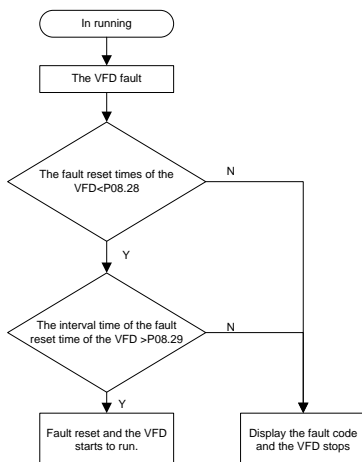

Relative parameters list:

Function code	Name	Description	Default
P00.01	Run command channel	0: Keypad running command (LED off) 1: Terminal running command channel (LED flickering) 2: Communication running command channel (LED on)	0
P00.11	ACC time 1	0.0–3600.0 s	Depend on model
P00.12	DEC time 1	0.0–3600.0 s	Depend on model
P01.00	Start mode	0: Start-up directly 1: Start-up after DC braking 2: Start-up after rotation speed tracking	0
P01.01	Starting frequency of direct start	0.00–50.00 Hz	0.00 Hz
P01.02	Retention time of the starting frequency	0.0–50.00 s	0.00s
P01.03	The braking current before starting	0.0–100.0%	0.0%
P01.04	The braking time before starting	0.0–30.0 s	0.0s
P01.05	ACC/DEC selection	0: Linear type	0

Function code	Name	Description	Default
		1: S curve	
P01.06	ACC time of the starting step of S curve	0.0–50.0s	0.1s
P01.07	DEC time of the ending step of S curve	0.0–50.0s	0.1s
P01.08	Stop mode	0: Decelerate to stop 1: Coast to stop	0
P01.09	Starting frequency of DC braking	0.00 Hz–P00.03 (max. output frequency)	0.00 Hz
P01.10	Waiting time of DC braking	0.00–30.00 s	0.00s
P01.11	DC braking current	0.0–100.0%	0.0%
P01.12	DC braking time	0.0–50.0 s	0.0 s
P01.13	Dead time of FWD/REV rotation	0.0–3600.0 s	0.0 s
P01.14	Shifting between FWD/REV rotation	0: Switch after zero frequency 1: Switch after the starting frequency	0
P01.15	Stopping speed	0.00–100.00 Hz	0.20 Hz
P01.16	Detection of stopping speed	0: Speed setting (the only detection method in SVPWM mode) 1: Speed detecting value	0
P01.18	Terminal running protection when powering on	0: The terminal running command is invalid when powering on 1: The terminal running command is valid when powering on	0
P01.19	Action if running frequency < lower limit frequency (valid >0)	0: Run at the lower-limit frequency 1: Stop 2: Hibernation 3: Run at zero frequency	0
P01.20	Hibernation restore delay time	0.0–3600.0s (valid when P01.19=2)	0.0s
P01.21	Restart after power off	0: Disable 1: Enable	0
P01.22	The waiting time of restart after power off	0.0–3600.0 s (valid when P01.21=1)	1.0s
P01.23	Start delay time	0.00–60.00 s	0.00s
P01.24	Delay time of the stopping speed	0.00–60.00 s	0.00s
P05.01–P05.09	Digital input function selection	1: Forward rotation operation 2: Reverse rotation operation 4: Forward rotation jogging	

Function code	Name	Description	Default
		5: Reverse rotation jogging 6: Coast to stop 7: Fault reset 8: Operation pause 21: ACC/DEC time option 1 22: ACC/DEC time option 2 30: ACC/DEC prohibition	
P08.00	ACC time 2	0.0–3600.0 s	Depend on model
P08.01	DEC time 2	0.0–3600.0 s	Depend on model
P08.02	ACC time 3	0.0–3600.0 s	Depend on model
P08.03	DEC time 3	0.0–3600.0 s	Depend on model
P08.04	ACC time 4	0.0–3600.0 s	Depend on model
P08.05	DEC time 4	0.0–3600.0 s	Depend on model
P08.06	Jogging frequency	0.00–P00.03 (max. output frequency)	5.00 Hz
P08.07	Jogging ACC time	0.0–3600.0 s	Depend on model
P08.08	Jogging DEC time	0.0–3600.0 s	Depend on model
P08.28	Fault reset times	0–10	0
P08.29	Interval time of automatic fault reset	0.1–3200.0 s	1.0 s

7.8 Frequency setting

Goodrive35 series VFDs can set the frequency by various means. The given channel can be divided into main given channel and assistant given channel.

There are two main given channels: A frequency given channel and B frequency given channel. These two given channels can carry out mutual simple math calculation between each other. And the given channels can be shifted dynamically through set multi-function terminals.

There are three assistant given channels: keypad **UP/DOWN** input, terminals **UP/DOWN** switch input and digital potentiometer input. The three ways equal to the effect of input **UP/DOWN** given in internal

assistant given of the VFD. The user can enable the given method and the effect of the method to the frequency given by setting function codes.

The actual given of the VFD is consisted of main given channel and assistant given channel.

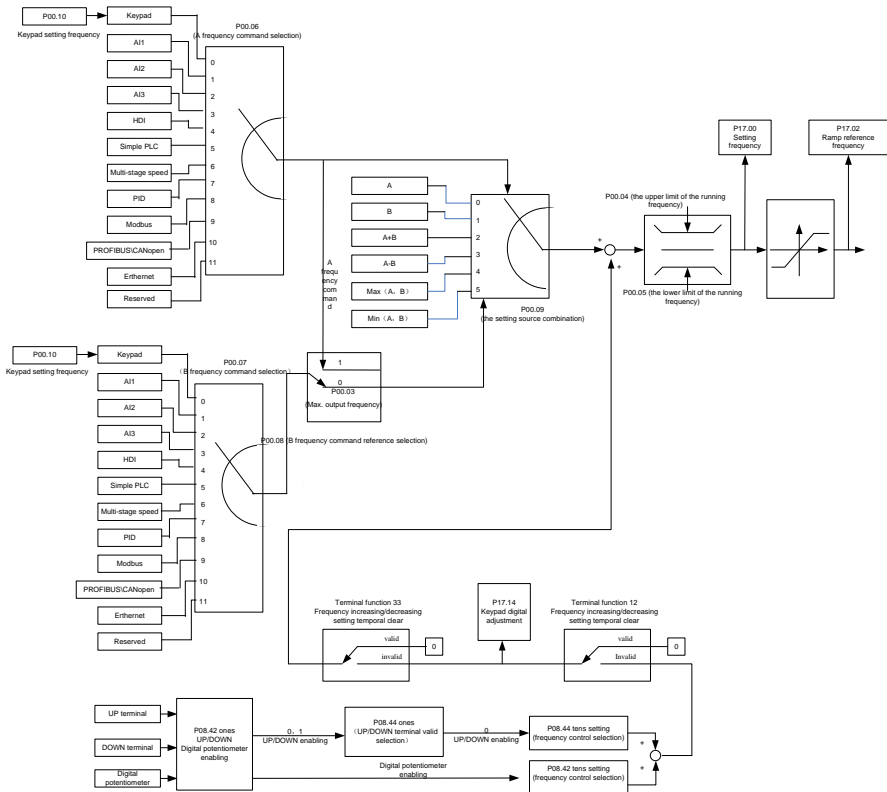

Goodrive35 series VFDs support the shifting between different given channels, and the detailed shifting rules is as below:

Current reference channel P00.09	Multi-function terminal function 13 Switch from A channel to B channel	Multi-function terminal function 14 Switch from combination setting to A channel	Multi-function terminal function 15 Switch from combination setting to B channel
A	B	/	/
B	/	/	/
A+B	/	A	B
A-B	/	A	B

Current reference channel P00.09	Multi-function terminal function 13 Switch from A channel to B channel	Multi-function terminal function 14 Switch from combination setting to A channel	Multi-function terminal function 15 Switch from combination setting to B channel
Max (A, B)	/	A	B
Min (A, B)	/	A	B

Note: "/" means the multi-function terminal is invalid under the current given channel.

When select multi-function terminal UP (10) and DOWN (11) to set the internal assistant frequency, P08.44 and P08.45 can be set to increase or decrease the set frequency quickly.

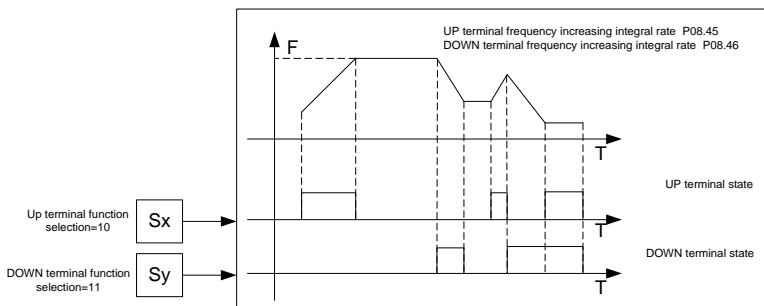

Relative parameters list:

Function code	Name	Description	Default
P00.03	Max. output frequency	P00.04–400.00 Hz	50.00 Hz
P00.04	Upper limit of the running frequency	P00.05–P00.03	50.00 Hz
P00.05	Lower limit of the running frequency	0.00 Hz–P00.04	0.00 Hz
P00.06	A frequency command	0: Keypad	0
P00.07	B frequency command	1: AI1 2: AI2 3: AI3 4: High-speed pulse HDI setting 5: Simple PLC program setting 6: Multi-step speed running setting 7: PID control setting 8: Modbus communication setting 9: PROFIBUS/CANopen communication	2

Function code	Name	Description	Default
		setting 10: Ethernet communication setting 11: Reserved 12: Pulse string AB setting	
P00.08	B frequency command reference	0: Maximum output frequency 1: A frequency command	0
P00.09	Combination of the setting source	0: A 1: B 2: (A+B) combination 3: (A-B) combination 4: Max (A, B) combination 5: Min (A, B) combination	0
P05.01–P05.09	Multi-function digital input terminals (S1–S8,HDI) function selection	10: Increasing frequency setting (UP) 11: Decreasing frequency setting (DOWN) 12: Cancel the frequency change setting 13: Shift between A setting and B setting 14: Shift between combination setting and A setting 15: Shift between combination setting and B setting	
P08.42	Keypad data control	0x0000–0x1223 LED ones: Frequency enable selection 0: Both \wedge/\vee keys and digital potentiometer adjustments are valid 1: Only \wedge/\vee keys adjustment is valid 2: Only digital potentiometer adjustments is valid 3: Neither \wedge/\vee keys nor digital potentiometer adjustments are valid LED tens: Frequency control selection 0: Only valid when P00.06=0 or P00.07=0 1: Valid for all frequency setting manner 2: Invalid for multi-step speed when multi-step speed has the priority LED hundreds: Action during stopping 0: Setting is valid 1: Valid during running, cleared after stopping	0x0000

Function code	Name	Description	Default
		2: Valid during running, cleared after receiving the stop command LED thousands: \wedge/\vee keys and digital potentiometer Integral function 0: The Integral function is valid 1: The Integral function is invalid	
P08.43	Integral ratio of the keypad potentiometer	0.01–10.00 Hz/s	0.10 Hz/s
P08.44	<u>UP/DOWN</u> terminals control	0x00–0x221 LED ones: Frequency control selection 0: <u>UP/DOWN</u> terminals setting valid 1: <u>UP/DOWN</u> terminals setting valid LED tens: Frequency control selection 0: Only valid when P00.06=0 or P00.07=0 1: All frequency means are valid 2: Invalid for multi-step speed when multi-step speed takes priority LED hundreds: Action selection when stop 0: Setting valid 1: Valid in the running, clear after stop 2: Valid in the running, clear after receiving the stop commands	0x000
P08.45	UP terminals frequency changing ratio	0.01–50.00 Hz/s	0.50 Hz/s
P08.46	DOWN terminals frequency changing ratio	0.01–50.00 Hz/s	0.50 Hz/s
P17.00	Setting frequency	Range: 0.00 Hz–P00.03 (max. output frequency)	0.00 Hz
P17.02	Ramp reference frequency	Range: 0.00 Hz–P00.03 (max. output frequency)	0.00 Hz
P17.14	Digital adjustment	0.00 Hz–P00.03	0.00 Hz

7.9 Analog input

Goodrive35 series VFDs have three analog input terminals and 1 high-speed pulse input terminals (of which, AI1 and AI2 are 0–10 V/0–20mA and AI can select voltage input or current input by J3, AI2 can select voltage input or current input by J4 and AI3 is for -10–10 V) as the standard configuration. The inputs can be filtered and the maximum and minimum values can be adjusted.

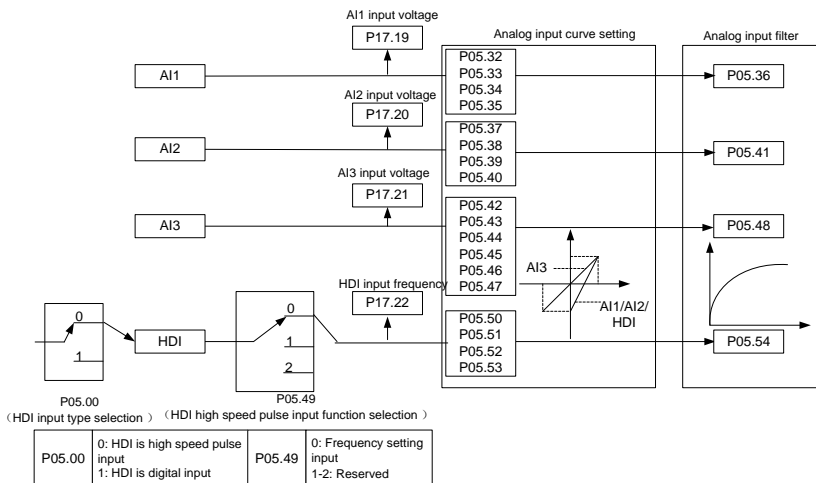

Relative parameters list:

Function code	Name	Description	Default
P05.00	HDI input selection	0: High pulse input 1: Digital input.	0
P05.32	Lower limit of AI1	0.00 V–P05.34	0.00 V
P05.33	Corresponding setting of lower limit of AI1	-300.0%–300.0%	0.0%
P05.34	Upper limit of AI1	P05.23–10.00 V	10.00 V
P05.35	Corresponding setting of upper limit of AI1	-300.0%–300.0%	100.0%
P05.36	AI1 input filter time	0.000s–10.000s	0.030 s
P05.37	Lower limit of AI2	0.00 V–P05.39	0.00 V
P05.38	Corresponding setting of lower limit of AI2	-300.0%–300.0%	0.0%
P05.39	Upper limit of AI2	P05.37–10.00 V	10.00 V
P05.40	Corresponding setting of upper limit of AI2	-300.0%–300.0%	100.0%
P05.41	AI2 input filter time	0.000s–10.000 s	0.030 s
P05.42	Lower limit of AI3	-10.00 V–P05.44	-10.00 V
P05.43	Corresponding setting of lower limit of AI3	-300.0%–300.0%	-100.0%
P05.44	Zero-drift value of AI3	P05.42–P05.46	0.00 V
P05.45	Zero-point deadzone voltage of AI3	0.00–10.00 V	0.04 V
P05.46	Upper limit of AI3	P05.44–10.00 V	10.00 V
P05.47	Corresponding setting of upper limit of AI3	-300.0%–300.0%	100.0%

Function code	Name	Description	Default
P05.48	AI3 input filter time	0.000s–10.000 s	0.030 s
P05.49	HDI high-speed pulse input function	0: Frequency setting input 1–2: Reserved	0
P05.50	Lower limit frequency of HDI	0.00 kHz – P05.43	0.000 kHz
P05.51	Corresponding setting of HDI low frequency setting	-300.0%–300.0%	0.0%
P05.52	Upper limit frequency of HDI	P05.41–50.00 kHz	50.000 kHz
P05.53	Corresponding setting of upper limit frequency of HDI	-300.0%–300.0%	100.0%
P05.54	HDI frequency input filter time	0.000s–10.000 s	0.030 s

7.10 Analog output

Goodrive35 series VFDs have 2 analog output terminals (0–10 V or 0–20mA) and 1 high speed pulse output terminal. Analog output signal can be filtered and the maximum and minimum values can be adjusted. The analog output signals can be proportional to motor speed, output frequency, output current, motor torque, motor power, etc. 100% of the output current is relative to 2 times of the rated current of the VFD.

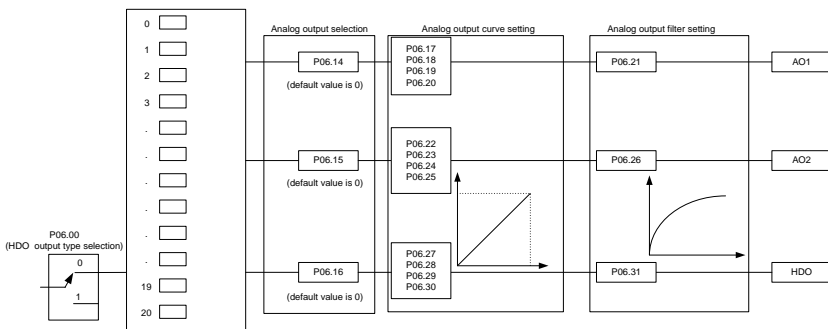

Output instructions:

Set value	Function	Instructions
0	Running frequency	0–max. output frequency
1	Set frequency	0–max. output frequency
2	Ramp reference frequency	0–max. output frequency
3	Running speed	0–2 times of the rated synchronous rotation speed of the motor

Set value	Function	Instructions
4	Output current (relative to the VFD)	0–2 times of rated current of the VFD
5	Output current (relative to the motor)	0–2 times of rated current of the VFD
6	Output voltage	0–1.5 times of the rated VFD voltage
7	Output power	0–2 times of the rated power
8	Setting torque value	0–2 times of rated current of the motor
9	Output torque	0–2 times of rated current of the motor
10	AI1	0–10 V/0–20 mA
11	AI2	0–10 V/0–20 mA
12	AI3	-10 V–10 V
13	HDI	0.00–50.00 kHz
14	Setting value 1 of Modbus communication	-1000–1000, 1000 corresponds to 100.0%
15	Setting value 2 of Modbus communication	-1000–1000, 1000 corresponds to 100.0%
16	Setting value 1 of PROFIBUS/CANopen communication	-1000–1000, 1000 corresponds to 100.0%
17	Setting value 2 of PROFIBUS/CANopen communication	-1000–1000, 100 corresponds to 100.0%
18	Setting value 1 of Ethernet communication	-1000–1000, 1000 corresponds to 100.0%
19	Setting value 2 of Ethernet communication	-1000–1000, 100 corresponds to 100.0%
20–21	Reserved	
22	Torque current (bipolar, 100% corresponds to 10 V)	0–2 times of the rated current of the motor
23	Exciting current (100% corresponds to 10 V)	0–1 time of the rated current of the motor
24	Setting frequency (bipolar)	0–max. output frequency
25	Ramp reference frequency (bipolar)	0–max. output frequency
26	Operation speed (bipolar)	0–max. output speed
27	Operation speed (positive polarity)	0–max. output speed

Relative parameters list:

Function code	Name	Description	Default
P06.00	HDO output	0: Open collector pole high speed pulse output 1: Open collector pole output.	0
P06.14	AO1 output	0: Running frequency	0
P06.15	AO2 output	1: Set frequency	0
P06.16	HDO high-speed pulse output	2: Ramps reference frequency 3: Running speed 4: Output current (relative to 2 times the rated current of the VFD)	0

Function code	Name	Description	Default
		5: Output current (relative to 2 times the rated current of the motor) 6: Output voltage (relative to 1.5 times the rated voltage of the VFD) 7: Output power (relative to 2 times the rated power of the motor) 8: Set torque value (relative to 2 times the rated torque of the motor) 9: Output torque (relative to 2 times the rated torque of the motor) 10: Analog AI1 input value 11: Analog AI2 input value 12: Analog AI3 input value 13: Input value of high-speed pulse HDIA 14: Set value 1 of Modbus communication 15: Set value 2 of Modbus communication 16: Set value 1 of PROFIBUS/CANopen communication 17: Set value 2 of PROFIBUS/CANopen communication 18: Set value 1 of Ethernet communication 19: Set value 2 of Ethernet communication 20–21: Reserved 22: Torque current (bipolar, 100% corresponds to 10 V) 23: Excitation current (100% corresponds to 10 V) 24: Setting frequency (bipolar) 25: Ramp reference frequency (bipolar) 26: Operation speed (bipolar) 27: Operation speed (positive polarity)	
P06.17	Lower output limit of AO1	-300.0%–P06.19	0.0%
P06.18	Corresponding AO1 output of lower limit	0.00 V–10.00 V	0.00 V
P06.19	Upper output limit of AO1	P06.13–300.0%	100.0%
P06.20	Corresponding AO1 output of upper limit	0.00 V–10.00 V	10.00 V

Function code	Name	Description	Default
P06.21	AO1 output filter time	0.000 s–10.000 s	0.000 s
P06.22	Lower output limit of AO2	-300.0%–P06.24	0.0%
P06.23	Corresponding AO2 output of lower limit	0.00 V–10.00 V	0.00 V
P06.24	Upper output limit of AO2	P06.18–300.0%	100.0%
P06.25	The corresponding AO2 output of upper limit	0.00 V–10.00 V	10.00 V
P06.26	AO2 output filter time	0.000 s–10.000 s	0.000 s
P06.27	Lower output limit of HDO	-300.0%–P06.29	0.0%
P06.28	Corresponding HDO output of lower limit	0.00–50.00 kHz	0.0 kHz
P06.29	Upper output limit of HDO	P06.23–300.0%	100.0%
P06.30	Corresponding HDO output of upper limit	0.00–50.00 kHz	50.00 kHz
P06.31	HDO output filter time	0.000 s–10.000 s	0.000 s

7.11 Digital input

Goodrive35 series VFDs have 8 programmable digital input terminals and 1 open circuit electrode output terminal in the standard configuration. All functions of the digital input terminals are programmable by the function codes. Open collector pole input can be selected into high speed pulse input terminal or common switch input terminal by function code. When selected into HDI, the user can select HDI high speed pulse input as frequency reference, counting input or length pulse input by setting.

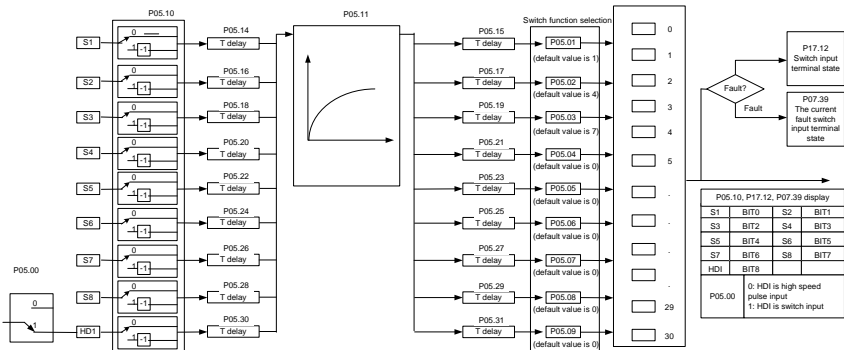

This parameter is used to set the function corresponds to the digital multi-function terminals.

Note: Two different multi-function terminals cannot be set as one function.

Set value	Function	Instructions
0	No function	The VFD does not work even there is input signal. It is necessary to set the terminal which cannot be used to non-function to avoid misacting.
1	Forward running (FWD)	The forward or reverse rotation of the VFD can be controlled by the external terminals.
2	Reverse running (REV)	
3	3-wire running control	The terminal can determine the running mode of the VFD is 3-wire control mode. Refer to P05.13 for detailed instruction of 3-wire control mode.
4	Forward jogging	See P08.06, P08.07 and P08.08 for jogging frequency, and jogging ACC/DEC time.
5	Reverse jogging	
6	Coast to stop	The VFD closes off the output. The motor is not controlled by the VFD during the stopping. This method is usually to be used when the load inertia is big and it has no requirement to the stopping time. It has the same meaning with the "coast to stop" in P01.08 and usually used in remote control.
7	Fault reset	External fault reset. It has the same function with the reset function of STOP/RST on the keypad. This function can realize remote fault reset.
8	Operation pause	The VFD decelerates to stop. But all running parameters are in the memory state. For example, PLC parameters, traverse parameters and PID parameters. After the signal disappears, the VFD will come back to the state before stopping.
9	External fault input	When the external fault signal is sent to the VFD, the VFD will report the fault and stop.
10	Frequency setting up (UP)	This parameter is used to modify the increasing and decreasing command during the external terminal given frequency.
12	Frequency setting down (DOWN)	
12	Frequency increasing/decreasing setting clear	<div style="text-align: center;"> <pre> graph LR K1 --- COM[COM] K2 --- COM K3 --- COM </pre> </div> <p>Frequency increasing/decreasing setting clear terminal can cancel the assistant channel frequency set by the internal UP/DOWN of the VFD to make the given frequency restore to the frequency given by the main given frequency channel.</p>

Set value	Function	Instructions																				
13	Switch between A setting and B setting	This function can realize the shifting between the frequency setting channels.																				
14	Switch between A setting and combination setting	The 13 th function can realize the shifting between A frequency given channel and B frequency given channel.																				
15	Switch between B setting and combination setting	The 14 th function can realize the shifting between A frequency given channel and the combination setting channel set by P00.09. The 15 th function can realize the shifting between B frequency given channel and the combination setting channel set by P00.09.																				
16	Multi-step speed terminal 1	The 16 stage speeds can be set by the combination of digital state of four terminals. Note: Multi-step speed 1 is the LSB; multi-step speed 4 is the MSB.																				
17	Multi-step speed terminal 2																					
18	Multi-step speed terminal 3																					
19	Multi-step speed terminal 4																					
		<table border="1"> <thead> <tr> <th>Multi-step speed 4</th> <th>Multi-step speed 3</th> <th>Multi-step speed 2</th> <th>Multi-step speed 1</th> </tr> </thead> <tbody> <tr> <td>BIT3</td> <td>BIT2</td> <td>BIT1</td> <td>BIT0</td> </tr> </tbody> </table>	Multi-step speed 4	Multi-step speed 3	Multi-step speed 2	Multi-step speed 1	BIT3	BIT2	BIT1	BIT0												
Multi-step speed 4	Multi-step speed 3	Multi-step speed 2	Multi-step speed 1																			
BIT3	BIT2	BIT1	BIT0																			
20	Multi-step speed pause	Shield the multi-step speed selection terminal function to keep the setting value at the current state.																				
21	ACC/DEC time selection 1	Select 4 ACC/DEC time by the combination of the 2 terminals.																				
22	ACC/DEC time selection 2	<table border="1"> <thead> <tr> <th>Terminal 1</th> <th>Terminal 2</th> <th>ACC/DEC time selection</th> <th>Corresponding parameter</th> </tr> </thead> <tbody> <tr> <td>OFF</td> <td>OFF</td> <td>ACC/DEC time 1</td> <td>P00.11/P00.12</td> </tr> <tr> <td>ON</td> <td>OFF</td> <td>ACC/DEC time 2</td> <td>P08.00/P08.01</td> </tr> <tr> <td>OFF</td> <td>ON</td> <td>ACC/DEC time 3</td> <td>P08.02/P08.03</td> </tr> <tr> <td>ON</td> <td>ON</td> <td>ACC/DEC time 4</td> <td>P08.04/P08.05</td> </tr> </tbody> </table>	Terminal 1	Terminal 2	ACC/DEC time selection	Corresponding parameter	OFF	OFF	ACC/DEC time 1	P00.11/P00.12	ON	OFF	ACC/DEC time 2	P08.00/P08.01	OFF	ON	ACC/DEC time 3	P08.02/P08.03	ON	ON	ACC/DEC time 4	P08.04/P08.05
Terminal 1	Terminal 2	ACC/DEC time selection	Corresponding parameter																			
OFF	OFF	ACC/DEC time 1	P00.11/P00.12																			
ON	OFF	ACC/DEC time 2	P08.00/P08.01																			
OFF	ON	ACC/DEC time 3	P08.02/P08.03																			
ON	ON	ACC/DEC time 4	P08.04/P08.05																			
23	Simple PLC stop reset	Restart simple PLC and clear memory state of PLC.																				
24	Simple PLC pause	Program pause during PLC implement. Run at the current speed stage. After cancel the function, simple PLC continues to run.																				
25	PID control pause	Temporal PID invalid and the VFD will output at the current frequency.																				
26	Limit of forward run	The function is valid only for forward run.																				

Set value	Function	Instructions
27	Limit of reverse run	The function is valid only for reverse run.
28	Counter reset	Counter clear
29	Torque control disabling	The VFD shifts from torque control mode to speed control mode.
30	ACC/DEC disabling	Ensure the VFD will not be affected by the external signals (except for the stopping command) and keep the current output frequency.
31	Counter triggering	Enable the pulse counter.
32	Length reset	Length counter clear
33	Frequency increasing/decreasing setting temporal clear	When the terminal closes, the frequency set by UP/DOWN can be cleared. All set frequency will be restored into the given frequency by the frequency command channel and the frequency will come back to the value after the frequency increasing or decreasing.
34	DC braking	The VFD will begin DC braking after valid command.
35	Switch between motor1 and motor2	Motor-shifting can be controlled after terminal is valid.
36	Switch commands to keypad	After the function terminal become valid, the running command channel will be shifted into keypad running command channel and the running command channel will come back to the original state if the function terminal is invalid.
37	Switch commands to terminals	After the function terminal become valid, the running command channel will be shifted into terminal running command channel and the running command channel will come back to the original state if the function terminal is invalid.
38	Switch commands to communication	After the function terminal become valid, the running command channel will be shifted into communication running command channel and the running command channel will come back to the original state if the function terminal is invalid.
39	Pre-excitation commands	Perform pre-exciting if the terminal is valid until the terminal is invalid.
40	Power consumption clear	The power consumption will be cleared after the command is valid.
41	Power consumption retention	If the command is valid, the current running of the VFD will not affect its power consumption.

Set value	Function	Instructions
42	Keypad setting of the torque upper limit	The upper limit is set by the keypad if the command is valid.
43	Position reference input (only S8 valid)	If S8 is set to 43, the external reference can be detected.
44	Spindle direction prohibit	The function is disabled if the command is valid.
45	Spindle returning /Local position returning	The function is enabled if the command is valid.
46	Zero position selection 1	46 and 47 can select 4 returning positions and correspond to the returning position of P22.
47	Zero position selection 2	
48	Spindle scaling selection 1	7 scaling selections are available through 48, 49, and 50 and correspond to the scaling position of P22.
49	Spindle scaling selection 2	
50	Spindle scaling selection 3	
51	Switching terminal of position control and speed control	Position control and speed control can be switched to achieve the pulse string reference control.
52	Pulse input disabled	Pulse input is disabled if the command is valid.
53	Position deviation clear	Position deviation can be cleared if the command is valid.
54	Position proportional gain switch	Position proportional gain can be switched.
55	Digital position cycle positioning enabled	When command is valid, repeated positioning in the digital position mode is available.
56	E-stop	When command valid, the motor will stop within the time designated by P1.25.
57	Motor overtemperature fault input	The motor will stop when fault occurs.
58	Rigid tapping enable	The mode is enabled if the terminal is valid
59	Switch to SVPWM control	If the terminal is valid in stopping mode, it will switch to V/F control
60	Switch to FVC control	If the terminal is valid in stopping mode, it will switch to FVC control
61	PID pole switching	The terminal is used with P09.03 to switch the output pole
62	Undervoltage stopping input	The terminal and the enabling bit is valid, the VFD will stop at the time set by P08.05
63	Servo enabling	Under the position mode, Servo enable signal is valid, the VFD will run into the servo mode, if there is no servo enable signal, the VFD needs to receive the forward or reverse run command to perform the servo operation mode.

Set value	Function	Instructions
63	Reserved	

Relative parameters list:

Function code	Name	Description	Default
P05.00	HDI input selection	0: High pulse input 1: Digital input	0
P05.01	S1 terminals function	0: No function	1
P05.02	S2 terminals function	1: Forward rotation operation	4
P05.03	S3 terminals function	2: Reverse rotation operation	7
P05.04	S4 terminals function	3: 3-wire control operation	0
P05.05	S5 terminals function	4: Forward jogging	0
P05.06	S6 terminals function	5: Reverse jogging	0
P05.07	S7 terminals function	6: Coast to stop	0
P05.08	S8 terminals function	7: Fault reset	0
P05.09	HDI terminal function	8: Operation pause 9: External fault input 10: Increasing frequency setting (UP) 11: Decreasing frequency setting (DOWN) 12: Frequency setting clear 13: Shift between A setting and B setting 14: Shift between combination setting and A setting 15: Shift between combination setting and B setting 16: Multi-step speed terminal 1 17: Multi-step speed terminal 2 18: Multi-step speed terminal 3 19: Multi- step speed terminal 4 20: Multi- step speed pause 21: ACC/DEC time 1 22: ACC/DEC time 2 23: Simple PLC stop reset 24: Simple PLC pause 25: PID control pause 26: Limit of forward running 27: Limit of reverse running 28: Electronic gear selection	0

Function code	Name	Description	Default
		29: Torque control disabling 30: ACC/DEC disabling 31: Pulse ascending 32: Pulse descending 33: Cancel the frequency change setting temporarily 34: DC braking 35: Shift the motor 1 into motor 2 36: Shift the command to the keypad 37: Shift the command to the terminals 38: Shift the command to the communication 39: Pre-magnetized command 40: Consumption power clear 41: Consumption power holding 42: Keypad setting of the torque upper limit 43: Position reference input (only S8 valid) 44: Spindle direction prohibit 45: Spindle returning/local position returning 46: Zero position selection 1 47: Zero position selection 2 48: Spindle scaling selection 1 49: Spindle scaling selection 2 50: Spindle scaling selection 3/pulse superposition enabling 51: Switching terminal of position control and speed control 52: Pulse input disabled 53: Position deviation clear 54: Position proportional gain switch 55: Digital position cycle positioning enabled 56: E-stop 57: Motor overtemperature fault input 58: Rigid tapping enable 59: Switch to SVPWM control 60: Switch to FVC control 61: PID pole switching 62: Undervoltage stopping input 63: Servo enabling	

Function code	Name	Description	Default
P05.10	Polarity selection of the input terminals	0x000–0x1FF	0x000
P05.11	ON-OFF filter time	0.000–1.000 s	0.010 s
P05.12	Virtual terminals setting	0x000–0x1FF (0: Disabled, 1: Enabled) BIT0: S1 virtual terminal BIT1: S2 virtual terminal BIT2: S3 virtual terminal BIT3: S4 virtual terminal BIT4: S5 virtual terminal BIT5: S6 virtual terminal BIT6: S7 virtual terminal BIT7: S8 virtual terminal BIT8: HDI virtual terminal Note: After a virtual terminal is enabled, the state of the terminal can only be modified through communication, and the communication address is 0x200A.	0
P05.13	Terminals control running mode	0: 2-wire control 1 1: 2-wire control 2 2: 3-wire control 1 3: 3-wire control 2	0
P05.14	Switch-on delay of S1	0.000–50.000 s	0.000 s
P05.15	Switch-off delay of S1	0.000–50.000 s	0.000 s
P05.16	Switch-on delay of S2	0.000–50.000 s	0.000 s
P05.17	Switch-off delay of S2	0.000–50.000 s	0.000 s
P05.18	Switch-on delay of S3	0.000–50.000 s	0.000 s
P05.19	Switch-off delay of S3	0.000–50.000 s	0.000 s
P05.20	Switch-on delay of S4	0.000–50.000 s	0.000 s
P05.21	Switch-off delay of S4	0.000–50.000 s	0.000 s
P05.22	Switch-on delay of S5	0.000–50.000 s	0.000 s
P05.23	Switch-off delay of S5	0.000–50.000 s	0.000 s
P05.24	Switch-on delay of S6	0.000–50.000 s	0.000 s
P05.25	Switch-off delay of S6	0.000–50.000 s	0.000 s
P05.26	Switch-on delay of S7	0.000–50.000 s	0.000 s
P05.27	Switch-off delay of S7	0.000–50.000 s	0.000 s
P05.28	Switch-on delay of S8	0.000–50.000 s	0.000 s

Function code	Name	Description	Default
P05.29	Switch-off delay of S8	0.000–50.000 s	0.000 s
P05.30	Switch-on delay of HDI	0.000–50.000 s	0.000 s
P05.31	Switch-off delay of HDI	0.000–50.000 s	0.000 s
P07.39	Present fault input terminal state		0
P17.12	ON/OFF input terminals state	0000–01FF	0

7.12 Digital input

Goodrive35 series VFDs have 2 relay output terminals and 1 Y output terminal and 1 high speed pulse output terminal in the standard configuration. All functions of the digital input terminals are programmable by the function codes. Open collector pole input can be selected into high speed pulse input terminal or common switch input terminal by function code.

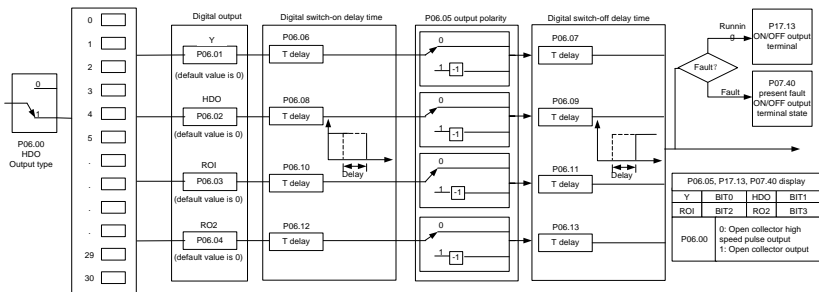

The below table is the option of the four function parameters and selecting the repeated output terminal function is allowed.

Set value	Function	Instructions
0	Invalid	The output terminal has no function.
1	Running	Output ON signal when the VFD is running and there is frequency output.
2	Forward running	Output ON signal when the VFD is running forward and there is frequency output.
3	Reverse running	Output ON signal when the VFD is running reverse and there is frequency output.
4	Jogging	Output ON signal when the VFD is jogging and there is frequency output.
5	VFD fault	Output ON signal when the VFD is in fault

Set value	Function	Instructions
6	FDT1	Please refer to P08.32 and P08.33 for detailed information.
7	FDT2	Please refer to P08.34 and P08.35 for detailed information.
8	Frequency arrival	Please refer to P08.36 for detailed information.
9	Zero-speed running	Output ON signal when the output frequency and given frequency of the VFD is 0 at the same time.
10	Upper-limit frequency arrival	Output ON signal when the running frequency of the VFD is the upper limit frequency.
11	Upper-limit frequency arrival	Output ON signal when the running frequency of the VFD is the lower limit frequency.
12	Ready to run	When the main circuit and the control circuit are established and the protection function of the VFD is not active. The VFD is in the running state and it will output ON signal.
13	Pre-exciting	Output ON signal when the VFD is in the pre-exciting state.
14	Overload pre-alarm	Output ON signal if the VFD is beyond the pre-alarm point. Refer to P11.08–P11.10 for the detailed instruction.
15	Underload pre-alarm	Output ON signal if the VFD is beyond the pre-alarm point. Refer to P11.11–P11.12 for the detailed instruction.
16	Simple PLC stage completion	Output signal if the simple PLC stage is completed.
17	Simple PLC cycle completion	Output signal if the 1 simple PLC cycle is completed.
23	Modbus communication virtual terminal output	Output corresponding signal according to the setting value of Modbus. Output ON signal if the setting value is 1 and output OFF signal if the setting value is 0.
24	PROFIBUS/CANopen communication virtual terminal output	Output corresponding signal according to the setting value of PROFIBUS/CANOPEN. Output ON signal if the setting value is 1 and output OFF signal if the setting value is 0.
25	Ethernet communication virtual terminal output	Output the corresponding signal according to the Ethernet signal. Output ON when setting as 1 and output OFF when setting as 0.
26	Bus voltage established	Output ON according to the establishment of bus voltage
27–29	Reserved	
30	Positioning finished	Output ON when the positioning is finished
31	Spindle returning finished	Output ON when the returning is finished
32	Spindle scaling finished	Output ON when the scaling is finished
33	Speed limit reached in torque control	Output ON when the speed is the upper or lower limit

Set value	Function	Instructions
34	Low bus voltage	Output ON when the value is below P8.27
35	Underload stopping output	If enabling bit of P08.26 is valid, and it is in underload state, ON signal will be output
36	Speed/position switching finished	When the speed is switched to position control, output ON signal

Relative parameters list:

Function code	Name	Description	Default
P06.00	HDO output	0: Open collector pole high speed pulse output 1: Open collector pole output	0
P06.01	Y1 output	0: Invalid	0
P06.02	HDO output	1: In operation	0
P06.03	Relay RO1 output	2: Forward rotation operation 3: Reverse rotation operation	1
P06.04	Relay RO2 output	4: Jogging operation 5: VFD fault 6: Frequency degree test FDT1 7: Frequency degree test FDT2 8: Frequency arrival 9: Zero speed running 10: Upper limit frequency arrival 11: Lower limit frequency arrival 12: Ready for operation 13: In pre-exciting 14: Overload pre-alarm 15: Underload pre-alarm 16: Completion of simple PLC stage 17: Completion of simple PLC cycle 18–22: Reserved 23: Modbus communication virtual terminals output 24: PROFIBUS/CANopen communication virtual terminals output 25: Ethernet communication virtual terminals output	5

Function code	Name	Description	Default
		26: Bus voltage established 27: Reserved 28: Pulse superposing 29: Reserved 30: Positioning finished 31: Spindle zeroing finished 32: Spindle scaling finished 33: Speed limit reached in torque control 34: Bus voltage too low 35: Bus undervoltage stop state output 36: Speed/position control switching finished 37–40: Reserved	
P06.05	Polarity of output terminals	0x00–0x0F	0x00
P06.06	Y1 switch-on delay time	0.000–50.000 s	0.000 s
P06.07	Y1 switch-off delay time	0.000–50.000 s	0.000 s
P06.08	HDO switch-on delay	0.000–50.000 s (valid only when P06.00=1)	0.000 s
P06.09	HDO switch-off delay	0.000–50.000 s (valid only when P06.00=1)	0.000 s
P06.10	RO1 switch-on delay	0.000–50.000 s	0.000 s
P06.11	RO1 switch-off delay	0.000–50.000 s	0.000 s
P06.12	RO2 switch-on delay	0.000–50.000 s	0.000 s
P06.13	RO2 switch-off delay	0.000–50.000 s	0.000 s
P07.40	Output terminal state at present fault		0
P17.13	Digital output terminals state		0

7.13 Simple PLC

Simple PLC function is also a multi-step speed generator. The VFD can change the running frequency, direction to meet the need of processing according to the running time automatically. In the past, this function needs to be assisted by external PLC, but now the VFD can realize this function by itself.

The series VFDs can control 16-stage speed with 4 groups of ACC/DEC time.

The multi-function digital output terminals or multi-function relay output an ON signal when the set PLC finishes a circle (or a stage).

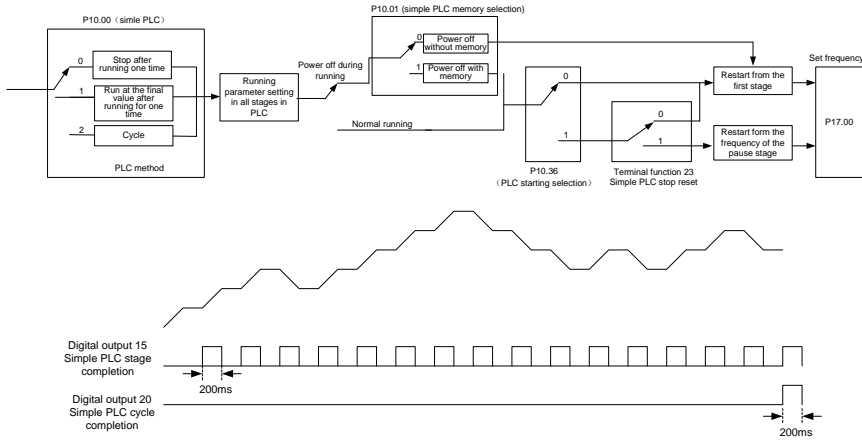

Relative parameters list:

Function code	Name	Description	Default
P10.00	Simple PLC	0: Stop after running once 1: Run at the final value after running once 2: Cycle running	0
P10.01	Simple PLC memory	0: Power loss without memory 1: Power loss with memory	0
P10.02	Multi-step speed 0	-100.0-100.0%	0.0%
P10.03	The running time of step 0	0.0-6553.5 s (min)	0.0 s
P10.04	Multi-step speed 1	-100.0-100.0%	0.0%
P10.05	The running time of step 1	0.0-6553.5 s (min)	0.0 s
P10.06	Multi-step speed 2	-100.0-100.0%	0.0%
P10.07	The running time of step 2	0.0-6553.5 s (min)	0.0 s
P10.08	Multi-step speed 3	-100.0-100.0%	0.0%
P10.09	The running time of step 3	0.0-6553.5 s (min)	0.0s
P10.10	Multi-step speed 4	-100.0-100.0%	0.0%
P10.11	The running time of step 4	0.0-6553.5 s (min)	0.0 s
P10.12	Multi-step speed 5	-100.0-100.0%	0.0%
P10.13	The running time of step 5	0.0-6553.5 s (min)	0.0 s
P10.14	Multi-step speed 6	-100.0-100.0%	0.0%
P10.15	The running time of step 6	0.0-6553.5 s (min)	0.0 s
P10.16	Multi-step speed 7	-100.0-100.0%	0.0%
P10.17	The running time of step 7	0.0-6553.5 s (min)	0.0 s

Function code	Name	Description	Default
P10.18	Multi-step speed 8	-100.0–100.0%	0.0%
P10.19	The running time of step 8	0.0–6553.5 s (min)	0.0 s
P10.20	Multi-step speed 9	-100.0–100.0%	0.0%
P10.21	The running time of step 9	0.0–6553.5 s (min)	0.0 s
P10.22	Multi-step speed 10	-100.0–100.0%	0.0%
P10.23	The running time of step 10	0.0–6553.5 s (min)	0.0 s
P10.24	Multi-step speed 11	-100.0–100.0%	0.0%
P10.25	The running time of step 11	0.0–6553.5 s (min)	0.0 s
P10.26	Multi-step speed 12	-100.0–100.0%	0.0%
P10.27	The running time of step 12	0.0–6553.5 s (min)	0.0 s
P10.28	Multi-step speed 13	-100.0–100.0%	0.0%
P10.29	The running time of step 13	0.0–6553.5 s (min)	0.0 s
P10.30	Multi-step speed 14	-100.0–100.0%	0.0%
P10.31	The running time of step 14	0.0–6553.5 s (min)	0.0 s
P10.32	Multi-step speed 15	-100.0–100.0%	0.0%
P10.33	The running time of step 15	0.0–6553.5 s (min)	0.0 s
P10.34	Simple PLC 0–7 step ACC/DEC time	0x0000–0xFFFF	0000
P10.35	Simple PLC 8–15 step ACC/DEC time	0x0000–0xFFFF	0000
P10.36	PLC restart	0: Restart from the first stage 1: Continue to run from the stop frequency	0
P05.01–P 05.09	Digital input function selection	23: Simple PLC stop reset 24: Simple PLC pause 25: PID control pause	
P06.01–P 06.04	Digital output function	15: Underload pre-alarm 16: Completion of simple PLC stage	
P17.00	Set frequency	0.00 Hz–P00.03 (max. output frequency)	0.00 Hz
P17.27	Simple PLC and present stage of the multi-step speed	0–15	0

7.14 Multi-step speed running

Set the parameters when the VFD carries out multi-step speed running. Goodrive35 series VFDs can set 16-stage speed which can be selected by the combination code of multi-step speed terminals 1–4. They correspond to multi-step speed 0 to 15.

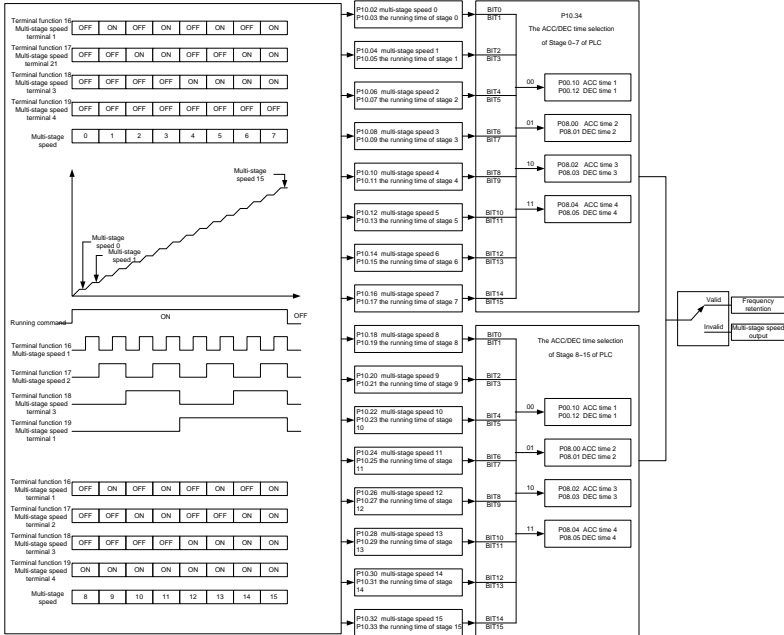

Relative parameters list:

Function code	Name	Description	Default
P10.02	Multi-step speed 0	-100.0~100.0%	0.0%
P10.03	The running time of step 0	0.0~6553.5 s (min)	0.0 s
P10.04	Multi-step speed 1	-100.0~100.0%	0.0%
P10.05	The running time of step 1	0.0~6553.5 s (min)	0.0 s
P10.06	Multi-step speed 2	-100.0~100.0%	0.0%
P10.07	The running time of step 2	0.0~6553.5 s (min)	0.0 s
P10.08	Multi-step speed 3	-100.0~100.0%	0.0%
P10.09	The running time of step 3	0.0~6553.5 s (min)	0.0 s
P10.10	Multi-step speed 4	-100.0~100.0%	0.0%
P10.11	The running time of step 4	0.0~6553.5 s (min)	0.0 s
P10.12	Multi-step speed 5	-100.0~100.0%	0.0%
P10.13	The running time of step 5	0.0~6553.5 s (min)	0.0 s
P10.14	Multi-step speed 6	-100.0~100.0%	0.0%
P10.15	The running time of step 6	0.0~6553.5 s (min)	0.0 s
P10.16	Multi-step speed 7	-100.0~100.0%	0.0%

Function code	Name	Description	Default
P10.17	The running time of step 7	0.0–6553.5 s (min)	0.0 s
P10.18	Multi-step speed 8	-100.0–100.0%	0.0%
P10.19	The running time of step 8	0.0–6553.5 s (min)	0.0 s
P10.20	Multi-step speed 9	-100.0–100.0%	0.0%
P10.21	The running time of step 9	0.0–6553.5 s (min)	0.0 s
P10.22	Multi-step speed 10	-100.0–100.0%	0.0%
P10.23	The running time of step 10	0.0–6553.5 s (min)	0.0 s
P10.24	Multi-step speed 11	-100.0–100.0%	0.0%
P10.25	The running time of step 11	0.0–6553.5 s (min)	0.0 s
P10.26	Multi-step speed 12	-100.0–100.0%	0.0%
P10.27	The running time of step 12	0.0–6553.5 s (min)	0.0 s
P10.28	Multi-step speed 13	-100.0–100.0%	0.0%
P10.29	The running time of step 13	0.0–6553.5 s (min)	0.0 s
P10.30	Multi-step speed 14	-100.0–100.0%	0.0%
P10.31	The running time of step 14	0.0–6553.5 s (min)	0.0 s
P10.32	Multi-step speed 15	-100.0–100.0%	0.0%
P10.33	The running time of step 15	0.0–6553.5 s (min)	0.0 s
P10.34	Simple PLC 0–7 step ACC/DEC time	0x0000–0xFFFF	0000
P10.35	Simple PLC 8–15 step ACC/DEC time	0x0000–0xFFFF	0000
P05.01–P05.09	Digital input function selection	16: Multi-step speed terminal 1 17: Multi-step speed terminal 2 18: Multi-step speed terminal 3 19: Multi-step speed terminal 4 20: Multi-step speed pause	
P17.27	Simple PLC and the current step of the multi-step speed	0–15	0

7.15 PID control

PID control is commonly used to control the procedure through the controlled procedure. Adjust the output frequency by proportional, integral, differential operation with the dispersion of the target signals to stabilize the value on the target. It is possible to apply to the flow, pressure and temperature control. Figure of basic control is as below:

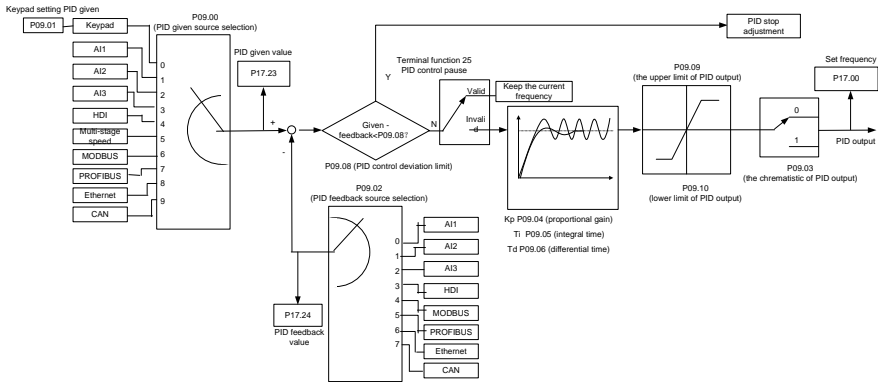

Simple illustration of the PID control operation and adjustment:

Proportional adjustment (Kp): when there is an error between the feedback and the reference, a proportional adjustment will be output. If the error is constant, the adjustment will be constant, too. Proportional adjustment can respond to the feedback change quickly, but it cannot realize non-fault control. The gain will increase with the adjustment speed, but too much gain may cause vibration. The adjustment method is: set a long integral time and derivative time to 0 first. Secondly make the system run by proportional adjustment and change the reference. And then watch the error of the feedback signal and the reference. If the static error is available (for example, increasing the reference, the feedback will be less than the reference after a stable system), continue to increase the gain, vice versa. Repeat the action until the static error achieves a little value.

Integral time (Ti): the output adjustment will accumulate if there is an error between the feedback and the reference. The adjustment will keep on increasing until the error disappears. If the error is existent all the time, the integration adjustor can cancel the static error effectively. Vibration may occur as a result of unstable system caused by repeated over-adjustment if the integration adjustor is too strong. The features of this kind of vibration are: the fluctuating feedback signal (around the reference) and increasing traverse range will cause vibration. Adjust the integral time parameter from a big value to a little one to change the integral time and monitor the result until a stable system speed is available.

Derivative time (Td): when the error between the feedback and the reference, a proportional adjustment will be output. The adjustment only depends on the direction and value of the error change other than the error itself. The derivation adjustment controls the change of feedback signals according to the changing trend when it fluctuates. Because the derivation may enlarge the interference to the system, especially the frequent-changing interference, please use it carefully.

When P00.06, P00.07=7 or P04.27=6, the running mode of the VFD is procedure PID control.

7.15.1 General steps of PID parameters setting:

1. Ensure the gain P

When ensure the gain P, firstly cancel the PID integration and derivation (set $T_i=0$ and $T_d=0$, see the PID parameter setting for detailed information) to make proportional adjustment is the only method to PID. Set the input as 60%–70% of the permitted max value and increase gain P from 0 until the system vibration occurs, vice versa, and record the PID value and set it to 60%–70% of the current value. Then the gain P commission is finished.

2. Ensure the integral time T_i

After ensuring the gain P, set an original value of a bigger integral time and decrease it until the system vibration occurs, vice versa, until the system vibration disappear. Record the T_i and set the integral time to 150%–180% of the current value. Then integral time commission is finished.

3. Ensure the derivative time T_d

Generally, it is not necessary to set T_d which is 0.

If it needs to be set, set it to 30% of the value without vibration via the same method with P and T_i .

4. Commission the system with and without load and then adjust the PID parameter until it is available.

7.15.2 PID inching

After setting the PID control parameters, inching is possible by following means:

Control overmodulation: Shorten the derivative time and prolong the integral time when overshoot occurs.

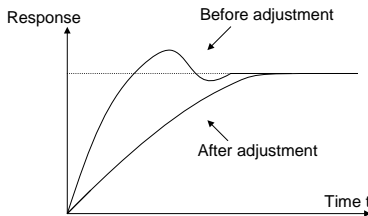

Achieve the stable state as soon as possible: Shorten the integral time (T_i) and prolong the derivative time (T_d) even the overshoot occurs, but the control should be stable as soon as possible.

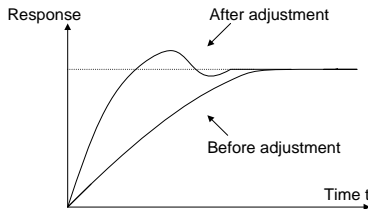

Control long vibration: If the vibration periods are longer than the set value of integral time (T_i), it is necessary to prolong the integral time (T_i) to control the vibration for the strong integration.

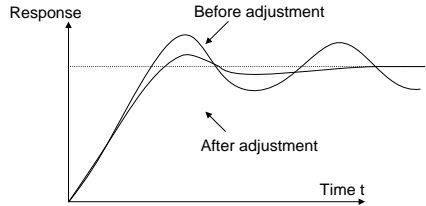

Control short vibration: Short vibration period and the same set value with the derivative time (Td) mean that the derivative time is strong. Shortening the derivative time (Td) can control the vibration. When setting the derivative time as 0.00 (ire no derivation control) is useless to control the vibration, decrease the gain.

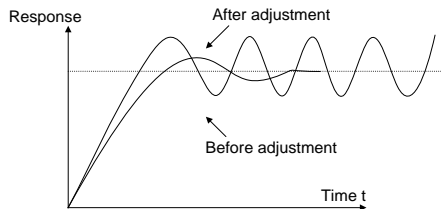

Relative parameters list:

Function code	Name	Description	Default
P09.00	PID reference source	0: Set by P09.01 1: AI1 2: AI2 3: AI3 4: HDI 5: Multi-step speed 6: Modbus communication 7: PROFIBUS/CANopen communication 8: Ethernet communication 9: Reserved	0
P09.01	PID value reference	-100.0%~100.0%	0.0%
P09.02	PID feedback source	0: AI1 1: AI2 2: AI3 3: HDI 4: Modbus communication feedback 5: PROFIBUS/CANopen communication feedback 6: Ethernet communication feedback 7: Reserved	0

Function code	Name	Description	Default
P09.03	PID output feature	0: PID output is positive 1: PID output is negative	0
P09.04	Proportional gain (Kp)	0.00–100.00	1.00
P09.05	Integral time (Ti)	0.00–50.00s	100 s
P09.06	Differential time (Td)	0.00–10.00s	0.00 s
P09.07	Sampling cycle (T)	0.001–1.000s	0.001 s
P09.08	PID control deviation limit	0.0–100.0%	0.0%
P09.09	Output upper limit of PID	P09.10–100.0% (max frequency or max voltage)	100.0%
P09.10	Output lower limit of PID	-100.0%–P09.09 (max frequency or max voltage)	0.0%
P09.11	Detection value of feedback offline	0.0–100.0%	0.0%
P09.12	Detection time of feedback offline	0.0–3600.0s	1.0 s
P09.13	PID adjustment	0x000–0x111 LED ones: 0: Keep integral adjustment ON while the frequency achieves upper or lower limit. 1: Stop integral adjustment while the frequency achieves upper or lower limit LED tens: 0: The same with the setting direction 1: Opposite to the setting direction LED hundreds: when P00.08 is 0 0: Limit to the maximum frequency 1: Limit to A frequency	0x001
P17.00	Set frequency	0.00 Hz–P00.03 (max. output frequency)	0.00 Hz
P17.23	PID reference	-100.0–100.0%	0.0%
P17.24	PID feedback	-100.0–100.0%	0.0%

7.16 Commissioning for special functions

7.16.1 Wiring mode of the encoder and pulse reference terminal

1. Differential output (suitable to C1, H1 and H2)

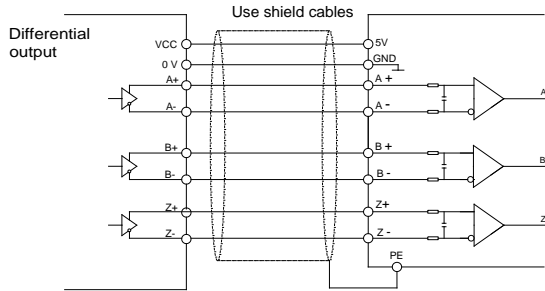

Note: The diagram of differential output is given to the H1 interface, C1 interface applies opto-isolator and H2 interface applies differential chips. The external wiring is the same as that of H1.

2. Open collector output (suitable to C1 and H1)

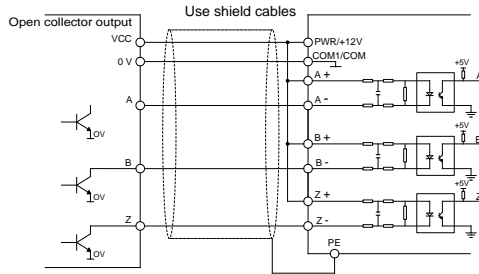

3. Complementary output (suitable to C1 and H1)

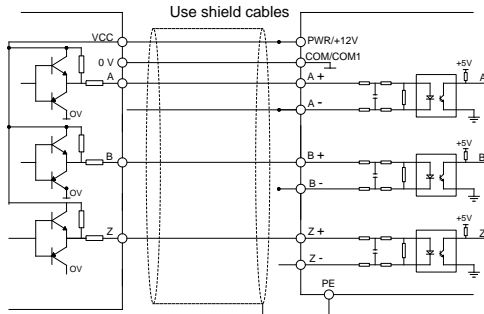

Note:

Above diagram are given to the features of common encoder and suitable to H1 interface.

The diagram of differential output is given to the H1 interface, C1 interface applies opto-isolator and H2 interface applies differential chips. The external wiring is the same as that of H1.

If the external current is limited, C1 and H1 interface is suitable to encoder signal and pulse reference signal input with greater voltage.

4. Push-pull output encoder connection

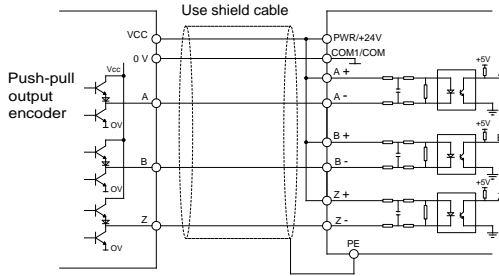

Push-pull output mode wiring diagram 1

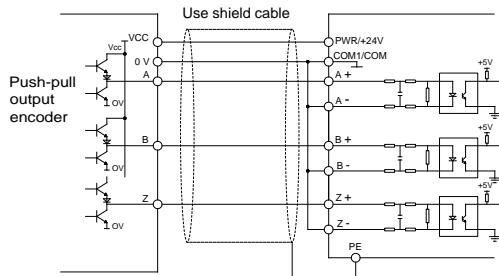

Push-pull output mode wiring diagram 2

Note: When this output mode is used, please refer to the electrical specifications of output current in the encoder manual.

1. If the flowing-in current of the output current is more than 25mA and the flowing-out current is less than 25mA and , please apply mode 1
2. If the flowing-in current of the output current is less than 25mA and the flowing-out current is more than 25mA, please apply mode 2
3. If the flowing-in and flowing-out current of the output current are more than 25mA, please apply mode 1 or 2.

Note: Z signal is needed for the spindle positioning VFD and the wiring is the same as that of A and B signal.

7.16.2 Commissioning steps

1. Closed-loop vector debugging of AM

- (1) Set P00.18=1 and restore to the factory settings.
- (2) Set the parameters of P00.03, P00.04 and P02 group
- (3) Motor autotuning
 - a) Set P00.15=1 and begin rotating autotuning
 - b) Set P00.15=2 and begin static autotuning

De-couple the load from the motor to carry out rotating autotuning; otherwise, carry out static autotuning. The parameters after autotuning can be saved in P02 group automatically.

- (4) Check the encoder is installed and correctly set
 - a) Ensure the encoder direction and parameters setting

Set P20.01 and set P00.00=2, P00.10=20 Hz. Start the VFD and watch the value of P18.00. If the value is negative, the direction of the encoder is reversed and it is necessary to set P20.02=1, if a huge bias exists, then the set value of P20.01 is wrong. Check if the fluctuation of P18.02 exists, then the set value of P20.01 is wrong and check the wiring and the shield layer.

- b) Ensure the direction of pulse Z

Set P00.10=20 Hz and P00.13 and observe the offset of P18.02 to ensure the value is less than 5. If the reverse function of pulse Z are not available after setting P20.02, then exchange A and B phase of the encoder after power off. And then observe the rotating value of P18.02 to ensure how far the forward value deviate from the reverse value. The direction of pulse Z only impacts the positioning accuracy of forward/reverse rotating if pulse Z is applied in the spindle positioning.

- (5) Trial running of the closed-loop vector

Set P00.00=3 to carry out closed-loop vector control. Adjust P00.10 and the ASR and ACR PI parameters in the P03 group to ensure the smooth running.

- (6) The weak magnetism control

Set P03.26=0–2000 and observe the weak magnetism control. Adjust P03.22–P03.24 according the actual need.

2. Closed-loop vector debugging of SM

- (1) Set P00.18=1 and restore to the factory settings.
- (2) Set P00.03=3, P00.03, P00.04 and the parameters in P02 group.
- (3) Set P20.00 and P20.01.

If rotary transformer encoder is selected, please set the pulse pair of the encoder (the number of pole pair*1024), if the pole pair is 4, please set P20.01=4096.

- (4) Check the encoder is installed and correctly set.

Observe the value of P18.21 after motor stopping to ensure the value has no fluctuations or small

fluctuations. But check the wiring and grounding if the fluctuation is huge. Rotate the motor slowly and the value of P18.21 may change slowly, too. If the value of P18.02 does not change and not equal to 0 after several cycles, then the signal of encoder Z is correct.

(5) Autotuning of the pole initial angle

Set P20.11=1 or 2 (1 is the rotating autotuning and 2 is the static autotuning) and press "RUN".

a) Rotating autotuning (P20.11=1)

Detect the pole position in the beginning, and then accelerate to 10 Hz to autotune the pole position of pulse Z, after that decelerate to stop.

If ENC1o or ENC1d occurs during the operation, please set P20.02=1 and then re-autotune. If ENC1Z occurs, check the connection of pulse Z.

The result will be saved in P20.09 and P20.10 after autotuning.

b) Static autotuning

It is recommended to apply rotating autotuning P20.11=1 to get higher autotuning precision if the load can be de-coupled. The other autotuning mode is also available if the load cannot de-couple. The pole position after autotuning is saved in P20.09 and P20.10.

(6) Trial running of the closed-loop vector

Adjust P0.10 and the ASR and ACR PI parameters in P3 group to ensure the smooth running. If fluctuation occurs, reduce the value of P03.00 and P03.03, and P03.09 and P03.10. If the current fluctuates at low speed, adjust P20.05.

Note: Reset P20.02 after change the motor or encoder wiring and re-autotune the angle of pulse Z.

3. Debugging steps of pulse string control

Pulse input is based on closed-loop vector control and speed detection is applied in the subsequent steps.

(1) Set P00.18=1 and restore to the factory settings.

(2) Set P00.03 and P00.04 and the parameters in P02 group.

(3) Motor autotuning: rotating autotuning and static autotuning.

(4) Check the encoder is installed and correctly set. Set P00.00=3 and P00.10=20 Hz and operate. Check the control and performance of the system.

(5) Set P21.00=0001 and select the position control as the position mode. There are 4 pulse command modes which can be selected by P21.01.

In the position mode, the user can select the high/LSB of the reference and feedback value, P18.02, P18.00, P18.17, P18.19 and the relationship between P18.08 and P18.02, P18.17, P18.18 and P18.19.

(6) P21.02 and P21.03 can be shifted through speed command, torque command and terminal

operation.

(7) If set P21.08 to 0, the position control is invalid, the pulse train is the frequency source and P21.13 is 100%. The deceleration and acceleration time are determined by the deceleration and acceleration time of the pulse train, but the deceleration and acceleration time of the pulse train in the system can be adjusted. If the pulse train is selected to control the speed, set P21.00=0000, P00.06 or P00.07=12, AB pulse train, then the acceleration and deceleration time depend on the time of the VFD and the parameter setting is determined by P21. In speed control mode, set the filter time of AB pulse by P21.29.

(8)The input frequency of the pulse train is the same as the feedback frequency of the encoder pulse. The relationship between them can be changed by modifying P21.11 and P21.12.

(9)When run command or servo enable is valid by setting P21.00 or terminal function 63, the VFD will run into the pulse string servo mode.

4. Debugging steps of spindle positioning

The spindle positioning is the function of stopping such as zeroing and scaling on the basis of closed-loop vector control.

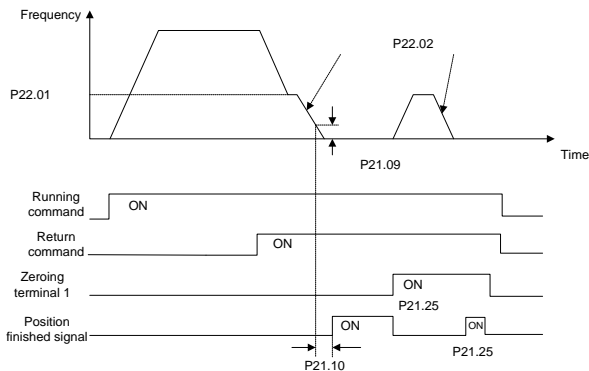

The steps of (1)–(4) are the same as the 4 steps in close-loop vector control mode. The function of spindle positioning is available in the position control mode and speed control mode.

(5) Set P22.00.bit0=1 and P22.00.bit1. If the system applies encoder to detect the speed, set P22.00.bit1=0, and if the system applies the photoelectric switch to detect the speed, set P22.00.bit1=1; set P22.00.bit2, P22.00.bit3 and P22.00.bit7

(6)Spindle zeroing

a) Set P22.00.bit4 to select the positioning direction.

b) There are 4 zero positions in P22 group. Set P05 to select the zeroing position. Operation on P18.10 can watch the stopping state.

c) The positioning length is determined by the deceleration time and the deceleration speed.

(7) Spindle scaling

There are 7 scale positions in P22 group. Set P05 to select the scale position. Enable corresponding terminal after motor stopping, the motor will inquiry the scaling state and turn to corresponding position. Operation on P18.09 can watch the state.

(8) Priority of the speed control, position control, zeroing and scaling

The priority of speed control > The priority of scaling. If the system runs at the scaling mode, when the spindle positioning is disabled, the motor will runs at the speed mode or position mode.

The priority of zeroing > The priority of scaling. The scaling commands are valid if the scaling terminal is turning from 000state to non-000state. If 000–011, then the spindle will operate scaling 3, the transition time of terminal switching is less than 10 ms, otherwise wrong scaling command may be carried out.

(9) Positioning retention

In positioning, the gain of position loop is P21.03, but when the positioning is finished, it is P21.02. Adjust P03.00, P03.01, P20.05 and P21.02 to keep the position and stabilize the system.

(10) Positioning command (bit6 of P22.00)

Signal of electrical level: Positioning command can only be executed after operation command or servo enable.

(11) Spindle reference selection (bit0 of P22.00)

Below positioning modes are available in encoder pulse Z positioning:

a) The encoder is installed on the motor shaft and the shaft is rigid-connected to the spindle with the ratio of 1: 1.

b) The encoder is installed on the motor shaft and the shaft is connected to the spindle by belt with the ratio of 1: 1.

It is recommended to begin positioning at the area close to the switch because the belt may slide when the spindle rotates at a high speed to cause inaccurate positioning.

c) The encoder is installed on the spindle and the motor shaft is connected to the spindle by belt. The drive ratio cannot be 1: 1.

It is necessary to set P20.06 and set P22.14 to be 1. The control performance of closed-loop vector may be affected if the encoder is not installed on the motor.

Below spindle positioning mode is available:

d) The encoder is installed on the motor shaft. The drive ratio cannot be 1: 1.

It is necessary to set P22.14 at the same time.

5. Digital positioning

The figure is shown as below:

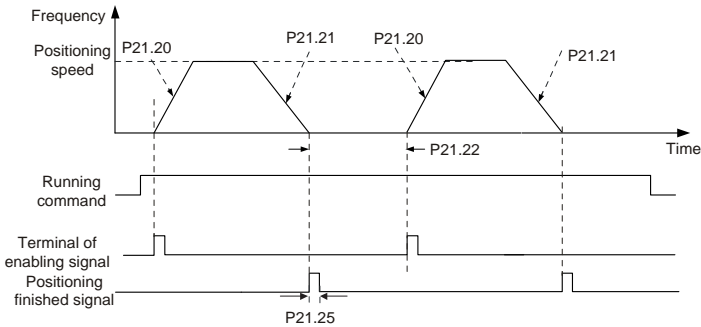

The steps of (1)–(4) are the same as the 4 steps in close-loop vector control mode. After the 4 steps, the control requirements can be met.

(5) Set P21.00=0011 and set P21.17, P21.11, P21.12, P21.18, P21.19, P21.20 and P21.21 according to actual needs.

(6) Single positioning operation

Set P21.16.bit1=0, and the motor will set as step (5) and keep on the positioning place.

(7) Cycle positioning operation

Set P21.16.bit1=1 to enable the loop positioning which includes continuous mode and repeated mode. The operation is also available by terminals function.

6. Photoelectric switch positioning

Photoelectric switch positioning is to position in the closed-loop vector control mode.

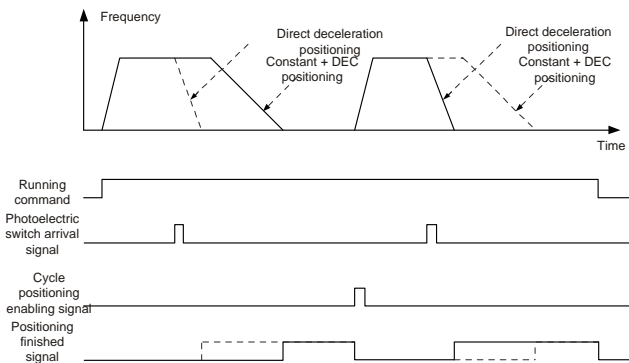

The steps of (1)–(4) are the same as the 4 steps in close-loop vector control mode. After the 4 steps, the control requirements can be met.

(5) Set P21.00=0021 to enable the positioning. The signal is only connected with S8. Set P05.08=43 and P21.17, P21.11, P21.12 and P21.21. If the operation speed is big or the setting placement is too small, the positioning deceleration time is invalid and it will enter into the direct deceleration mode.

(6) Cycle positioning operation

The motor will keep on the current position after positioning. Set group P05. If the terminal receives the enabling signal, the motor will operate at the setting speed in speed mode, after receiving photoelectric switch signal, it will position again.

(7) Positioning retention

During the positioning, the position loop gain is P21.03, but after positioning, it is P21.02. Adjust P03.00, P03.01, P20.05 and P21.02 to keep the position and avoid vibration.

7.17 Fault solutions

Goodrive35 series VFDs provide sufficient fault procedure information for the convenience of user's application.

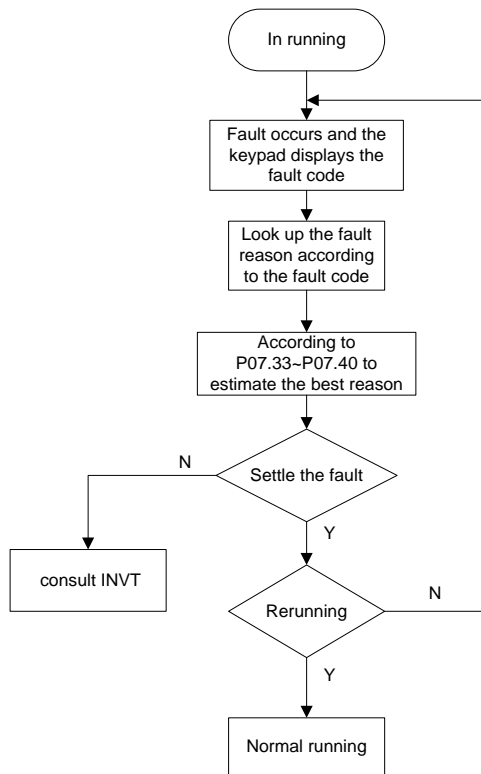

Relative parameters list:

Function code	Name	Description	Default
P07.27	Present fault type	0: No fault	0
P07.28	Type of the last fault	1: Inverter unit phase protection (OUT1)	
P07.29	Type of the last but one fault	2: Inverter unit V phase protection (OUT2) 3: Inverter unit W phase protection (OUT3)	
P07.30	Type of the last but two fault	4: ACC overcurrent (OC1)	
P07.31	Type of the last but three fault	5: DEC overcurrent (OC2) 6: Constant-speed overcurrent (OC3)	
P07.32	Type of the last but four fault	7: ACC overvoltage (OV1) 8: DEC overvoltage (OV2) 9: Constant-speed overvoltage (OV3) 10: Bus undervoltage (UV) 11: Motor overload (OL1) 12: VFD overload (OL2) 13: Input side phase loss (SPI) 14: Output side phase loss (SPO) 15: Overheat of the rectifier module (OH1) 16: Overheat fault of the inverter module (OH2) 17: External fault (EF) 18: 485 communication fault (CE) 19: Current detection fault (ItE) 20: Motor autotune fault (tE) 21: EEPROM operation fault (EEP) 22: PID response offline fault (PIDE) 23: Braking unit fault (bCE) 24: Running time arrival (END) 25: Electrical overload (OL3) 26: Panel communication fault (PCE) 27: Parameter uploading fault (UPE) 28: Parameter downloading fault (DNE) 29: PROFIBUS communication fault (E-DP) 30: Ethernet communication fault (E-NET)	

Function code	Name	Description	Default
		31: CANopen communication fault (E-CAN) 32: Grounding short circuit fault 1 (ETH1) 33: Grounding short circuit fault 2 (ETH2) 34: Speed deviation fault (dEu) 35: Maladjustment (STu) 36: Undervoltage fault (LL) 37: Encoder offline fault (ENC1o) 38: Encoder reverse fault (ENC1d) 39: Encoder pulse Z offline fault (ENC1Z) 43: Motor overtemperature fault (OT)	
P07.33	Running frequency at present fault		0.00 Hz
P07.34	Ramp reference frequency at present fault		0.00 Hz
P07.35	Output voltage at present fault		0 V
P07.36	Output current at present fault		0.0 A
P07.37	Bus voltage at present fault		0.0 V
P07.38	Max temperature at present fault		0.0°C
P07.39	Input terminal state at present fault		0
P07.40	Output terminal state at present fault		0
P07.41	Running frequency at last fault		0.00 Hz
P07.42	Ramp reference frequency at last fault		0.00 Hz
P07.43	Output voltage at last fault		0 V
P07.44	Output current at last fault		0.0 A
P07.45	Bus voltage at last fault		0.0 V
P07.46	Max temperature at last fault		0.0°C
P07.47	Input terminals state at last fault		0
P07.48	Output terminal state at last fault		0
P07.49	Running frequency at last but one fault		0.00 Hz
P07.50	Output voltage at last but one fault		0.00 Hz
P07.51	Output current at last but one fault		0 V
P07.52	Output current at last but one fault		0.0 A
P07.53	Bus voltage at last but one fault		0.0 V
P07.54	Highest temperature at last but one fault		0.0°C
P07.55	Input terminal state at last but one fault		0
P07.56	Output terminal state at last but one fault		0

8 Fault tracking

8.1 What this chapter contains

This chapter tells how to reset faults and view fault history. It also lists all alarm and fault messages including the possible cause and corrective actions.

	Only qualified electricians are allowed to maintain the VFD. Read the safety instructions in chapter Safety precautions before working on the VFD.
---	--

8.2 Alarm and fault indications

Fault is indicated by LEDs. See 4.5.1 "Protecting the VFD and input power cable in short-circuit situations". When **TRIP** light is on, an alarm or fault message on the panel display indicates abnormal VFD state. Using the information given in this chapter, most alarm and fault cause can be identified and corrected. If not, contact the INVT office.

8.3 How to reset

The VFD can be reset by pressing the keypad key **STOP/RST**, through digital input, or by switching the power light. When the fault has been removed, the motor can be restarted.

8.4 Fault history

Function codes P07.27–P07.32 store 6 recent faults. Function codes P07.33–P07.40, P07.41–P7.48, P07.49–P07.56 show drive operation data at the time the latest 3 faults occurred.

8.5 Fault instruction and solution

Do as the following after the VFD fault:

1. Check to ensure there is nothing wrong with the keypad. If not, contact the local INVT office.
2. If there is nothing wrong, please check P07 and ensure the corresponding recorded fault parameters to confirm the real state when the current fault occurs by all parameters.
3. See the following table for detailed solution and check the corresponding abnormal state.
4. Eliminate the fault and ask for relative help.
5. Check to eliminate the fault and carry out fault reset to run the VFD.

8.5.1 VFD faults and solutions

Note: The number enclosed in square brackets such as [1], [2], [3] in the Fault type column in the following table indicate the VFD fault type codes read through communication.

Code	Fault	Cause	Solution
OUt1	[1] Inverter unit U phase protection	●The acceleration is too fast ●There is damage to the internal to IGBT of the phase	●Increase acceleration time ●Change the power unit
OUt2	[2] Inverter unit V phase protection	●Misoperation is caused by interference.	●Check the driving wires ●Check if there is strong interference to the external equipment
OUt3	[3] Inverter unit W		

Code	Fault	Cause	Solution
	phase protection	<ul style="list-style-type: none"> ●The connection of the driving wires is not good ●Short-to-ground occurs. 	
OC1	[4] ACC overcurrent	<ul style="list-style-type: none"> ●The acceleration or deceleration is too fast 	<ul style="list-style-type: none"> ●Increase the ACC time ●Check the input power
OC2	[5] DEC overcurrent	<ul style="list-style-type: none"> ●The voltage of the grid is too low ●The power of VFD is too low 	<ul style="list-style-type: none"> ●Select the VFD with a larger power ●Check if the load is short circuited (the grounding short circuited or the wire short circuited) or the rotation is not smooth
OC3	[6] Constant-speed overcurrent	<ul style="list-style-type: none"> ●The load transients or is abnormal ●The grounding is short circuited or the output is phase loss ●There is strong external interference ●The overvoltage stall protection is not open 	<ul style="list-style-type: none"> ●Check the output configuration. ●Check if there is strong interference ●Check the setting of relative function codes
OV1	[7] ACC overvoltage		<ul style="list-style-type: none"> ●Check the input power
OV2	[8] DEC overvoltage	<ul style="list-style-type: none"> ●The input voltage is abnormal ●There is large energy feedback 	<ul style="list-style-type: none"> ●Check if the DEC time of the load is too short, or the motor is started when it is rotating.
OV3	[9] Constant-speed overvoltage	<ul style="list-style-type: none"> ●No braking components ●Braking energy is not open 	<ul style="list-style-type: none"> ●Install a dynamic braking components ●Check the setting of relative function codes
UV	[10] Bus undervoltage	<ul style="list-style-type: none"> ●The voltage of the grid is too low ●The overvoltage stall protection is not open 	<ul style="list-style-type: none"> ●Check the input power of the grid; ●Check the setting of relative function codes
OL1	[11] Motor overload	<ul style="list-style-type: none"> ●The voltage of the grid is too low ●The rated current of the motor is not correctly set ●The motor stall or load transients is too strong 	<ul style="list-style-type: none"> ●Check the power of the grid ●Reset the rated current of the motor ●Check the load and adjust the torque lift
OL2	[12] VFD overload	<ul style="list-style-type: none"> ●The acceleration is too fast ●Restart the rotating motor ●The voltage of the grid is too low. ●The load is too heavy. ●The motor power is too small. 	<ul style="list-style-type: none"> ●Increase the ACC time ●Avoid the restarting after stopping. ●Check the power of the grid ●Select a VFD with bigger power. ●Select a proper motor.
SPI	[13] Input side	<ul style="list-style-type: none"> ●Phase loss or fluctuation of input 	<ul style="list-style-type: none"> ●Check input power

Code	Fault	Cause	Solution
	phase loss	R,S,T	<ul style="list-style-type: none"> ●Check installation distribution
SPO	[14] Output side phase loss	<ul style="list-style-type: none"> ●U, V,W phase loss input (or serious asymmetrical three phase of the load) 	<ul style="list-style-type: none"> ●Check the output distribution ●Check the motor and cable
OH1	[15] Rectifying module overheated	<ul style="list-style-type: none"> ●Air duct jam or fan damage ●Ambient temperature is too high. 	<ul style="list-style-type: none"> ●Dredge the vent duct or replace the fan
OH2	[16] Inverter module overheated	<ul style="list-style-type: none"> ●The time of overload running is too long. 	<ul style="list-style-type: none"> ●Lower the ambient temperature
EF	[17] External fault	<ul style="list-style-type: none"> ●SI external fault input terminals act 	<ul style="list-style-type: none"> ●Check the external device input
CE	[18] 485 communication fault	<ul style="list-style-type: none"> ●The baud rate setting is incorrect. ●Fault occurs to the communication wiring. ●Communication address is wrong. ●There is strong interference to the communication. 	<ul style="list-style-type: none"> ●Set proper baud rate ●Check the communication connection distribution ●Set proper communication address. ●Chang or replace the connection distribution or improve the anti-interference capability.
ItE	[19] Current-detecting fault	<ul style="list-style-type: none"> ●The connection of the control board is not good ●Hall components is broken ●The modifying circuit is abnormal. 	<ul style="list-style-type: none"> ●Check the connector and re-plug ●Change the Hall ●Change the main control panel
tE	[20] Motor-autotuning fault	<ul style="list-style-type: none"> ●The motor capacity does not comply with VFD capability ●The rated parameter of the motor does not set correctly. ●The offset between the parameters from autotune and the standard parameter is huge ●Autotune overtime 	<ul style="list-style-type: none"> ●Change the VFD mode ●Set the rated parameter according to the motor name plate ●Empty the motor load and re-identify ●Check the motor connection and set the parameter. ●Check if the upper limit frequency is above 2/3 of the rated frequency.
EEP	[21] EEPROM operation fault	<ul style="list-style-type: none"> ●Error of controlling the write and read of the parameters ●Damage to EEPROM 	<ul style="list-style-type: none"> ●Press STOP/RST to reset ●Change the main control panel
PIDE	[22] PID feedback outline fault	<ul style="list-style-type: none"> ●PID feedback offline ●PID feedback source disappear 	<ul style="list-style-type: none"> ●Check the PID feedback signal ●Check the PID feedback source
bCE	[23] Braking unit	<ul style="list-style-type: none"> ●Braking circuit fault or damage to 	<ul style="list-style-type: none"> ●Check the braking unit and , change

Code	Fault	Cause	Solution
	fault	the braking pipes ●External braking resistor is insufficient	new braking pipe ●Increase the braking resistor
END	[24] Running time arrival	●The actual running time of the VFD is above the internal setting running time.	●Ask for the supplier and adjust the setting running time.
OL3	[25] Electrical overload	●VFD will report overload pre-alarm based on the set value.	●Check the load and the overload pre-alarm threshold.
PCE	[26] Keypad communication fault	●The connection of the keypad wires is not good or broken. ●The keypad wire is too long and affected by strong interference. ●There is circuit fault on the communication of the keypad and main board.	●Check the keypad wires and ensure whether there is mistake. ●Check the environment and avoid the interference source. ●Change the hardware and ask for service.
UPE	[27] Parameters uploading fault	●The connection of the keypad wires is not good or broken. ●The keypad wire is too long and affected by strong interference. ●There is circuit fault on the communication of the keypad and main board.	●Check the keypad wires and ensure whether there is mistake. ●Change hardware and ask for service. ●Change hardware and ask for service.
DNE	[28] Parameters downloading fault	●The connection of the keypad wires is not good or broken. ●The keypad wire is too long and affected by strong interference. ●There is mistake on the data storage of the keypad.	●Check the keypad wires and ensure whether there is mistake. ●Change the hardware and ask for service. ●Repack-up the data in the keypad.
E-DP	[29] PROFIBUS communication fault	●Communication address is wrong ●Corresponding resistor is not dialed ●The files of main stop GSD does not set sound ●The peripheral interference is too large.	●Check related setting ●Check the surrounding environment, and eliminate interference effects.
E-NET	[30] Ethernet communication fault	●Ethernet address is set improperly. ●Ethernet communication is wrong ●The peripheral interference is too large.	●Check the relative setting. ●Check the communication method selection. ●Check the surrounding environment,

Code	Fault	Cause	Solution
			and eliminate interference effects.
E-CAN	[31] CANopen communication fault	<ul style="list-style-type: none"> ●The connection is not sound ●Corresponding resistor is not dialed ●The communication baud rate is not matched ●The peripheral interference is too large. 	<ul style="list-style-type: none"> ●Check the connection ●Draw out the matching resistor ●Set the same baud rate ●Check the surrounding environment, and eliminate interference effects.
ETH1	[32] Grounding shortcut fault 1	<ul style="list-style-type: none"> ●The output of the VFD is short circuited with the ground. ●There is fault in the current detection circuit. ●The actual motor power sharply differs from the VFD power. 	<ul style="list-style-type: none"> ●Check if the connection of the motor is normal or not ●Change the hall ●Change the main control panel ●Set motor parameters correctly.
ETH2	[33] Grounding shortcut fault 2	<ul style="list-style-type: none"> ●The output of the VFD is short circuited with the ground. ●There is fault in the current detection circuit. ●The actual motor power sharply differs from the VFD power. 	<ul style="list-style-type: none"> ●Check if the connection of the motor is normal or not ●Change the Hall Change the main control panel ●Set motor parameters correctly.
dEu	[34] Speed deviation fault	<ul style="list-style-type: none"> ●The load is too heavy or stalled. 	<ul style="list-style-type: none"> ●Check the load and ensure it is normal. Increase the detection time. ●Check whether the control parameters are normal.
STo	[35] Maladjustment fault	<ul style="list-style-type: none"> ●The control parameters of the synchronous motors not set properly. ●The autotune parameter is not right. ●The VFD is not connected to the motor. 	<ul style="list-style-type: none"> ●Check the load and ensure it is normal. ●Check whether the control parameter is set properly or not. ●Increase the maladjustment detection time.
LL	[36] Electronic underload fault	<ul style="list-style-type: none"> ●The VFD will report the underload pre-alarm according to the set value. 	<ul style="list-style-type: none"> ●Check the load and the underload pre-alarm threshold.
ENC1o	[37] Encoder offline fault	<ul style="list-style-type: none"> ●Encoder line sequence error, or signal wire is connected improperly 	<ul style="list-style-type: none"> ●Check encoder wiring

Code	Fault	Cause	Solution
ENC1d	[38] Encoder reverse fault	●Encoder speed signal is contrary to running direction of the motor	●Reset encoder direction
ENC1Z	[39] Encoder pulse Z offline	●Z signal wire is disconnected	●Check Z signal wiring
OT	[43] Motor over-temperature fault	<ul style="list-style-type: none"> ●Motor overtemperature input terminal is valid ●Temperature detection resistor is abnormal ●Motor runs in overload condition in long time or it is abnormal 	<ul style="list-style-type: none"> ●Check the wiring of motor overtemperature input terminal (terminal function 57) ●Check whether temperature sensor functions normally ●Check and maintain the motor.

8.5.2 Other states

Code	State type	Possible cause	Solution
PoFF	System power off	System power off or bus voltage is too low	Check grid environment
	Communication between keypad and main control plate failed	Keypad is connected improperly	Check the installation of keypad

8.6 Common fault analysis

8.6.1 The motor does not work

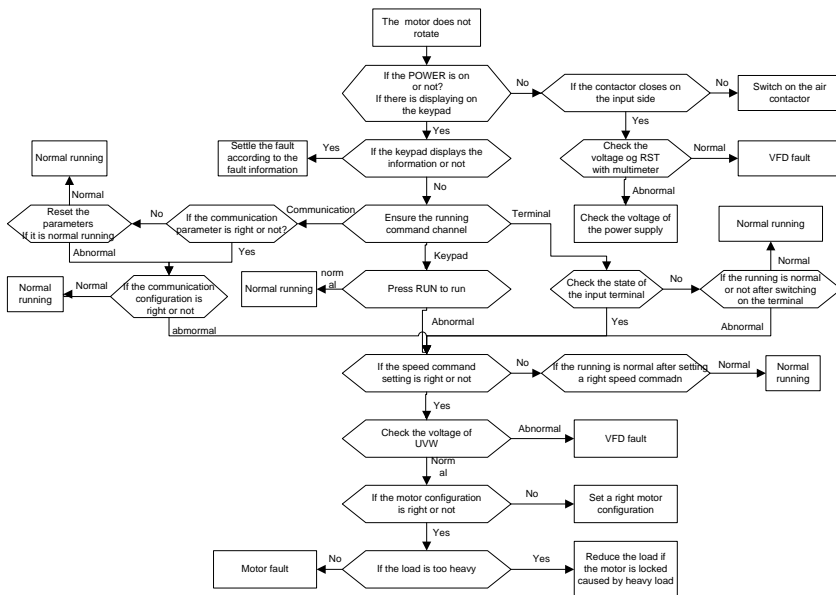

8.6.2 Motor vibration

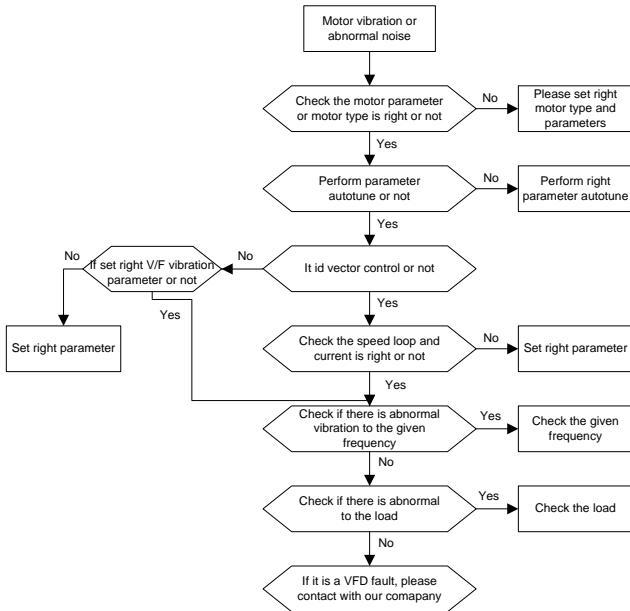

8.6.3 Overvoltage

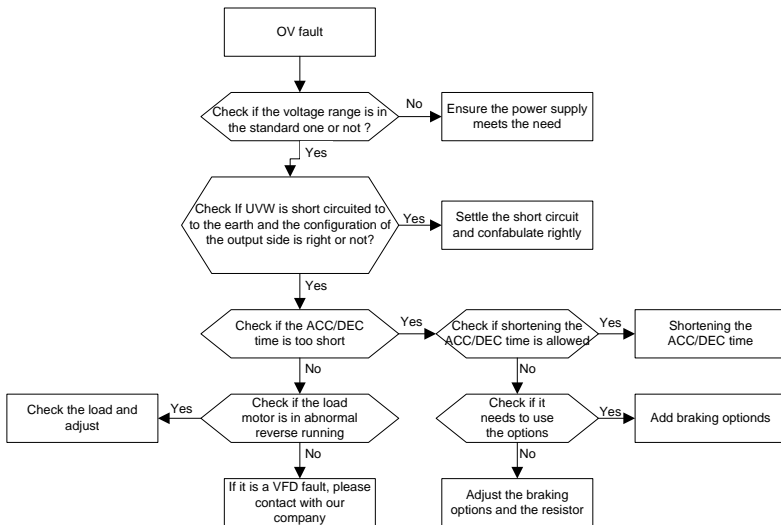

8.6.4 Undervoltage fault

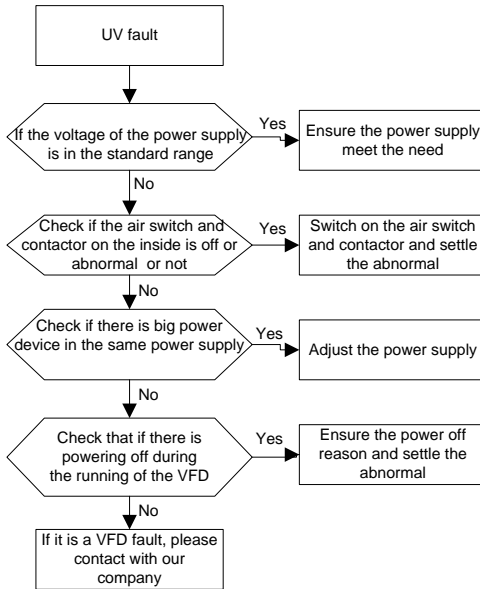

8.6.5 Abnormal heating of the motor

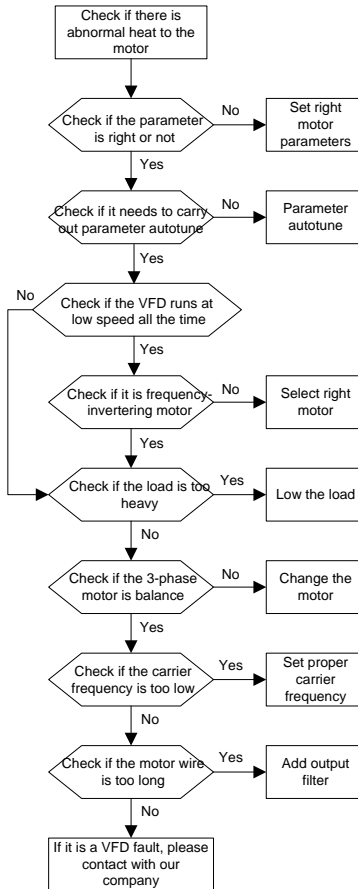

8.6.6 Overheat of the VFD

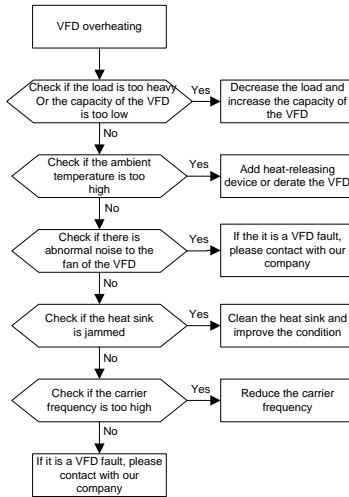

8.6.7 Motor stall during ACC

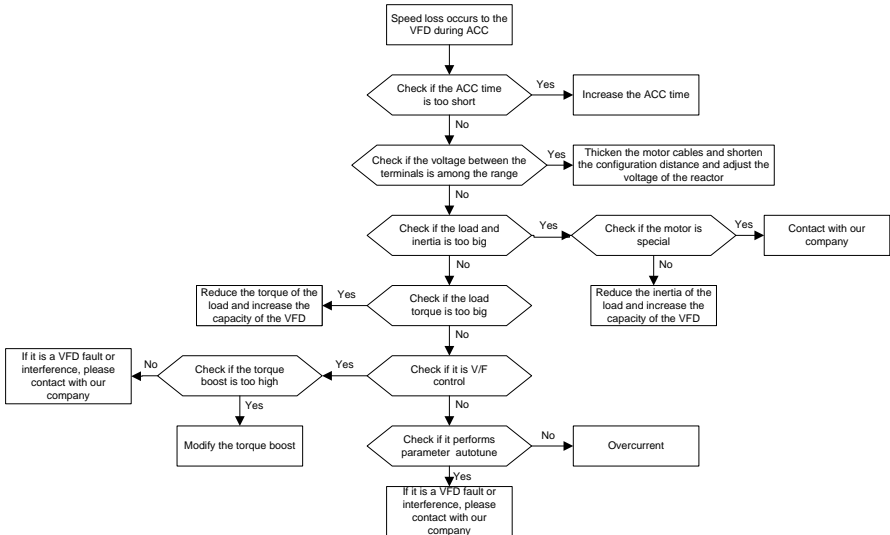

8.6.8 Overcurrent

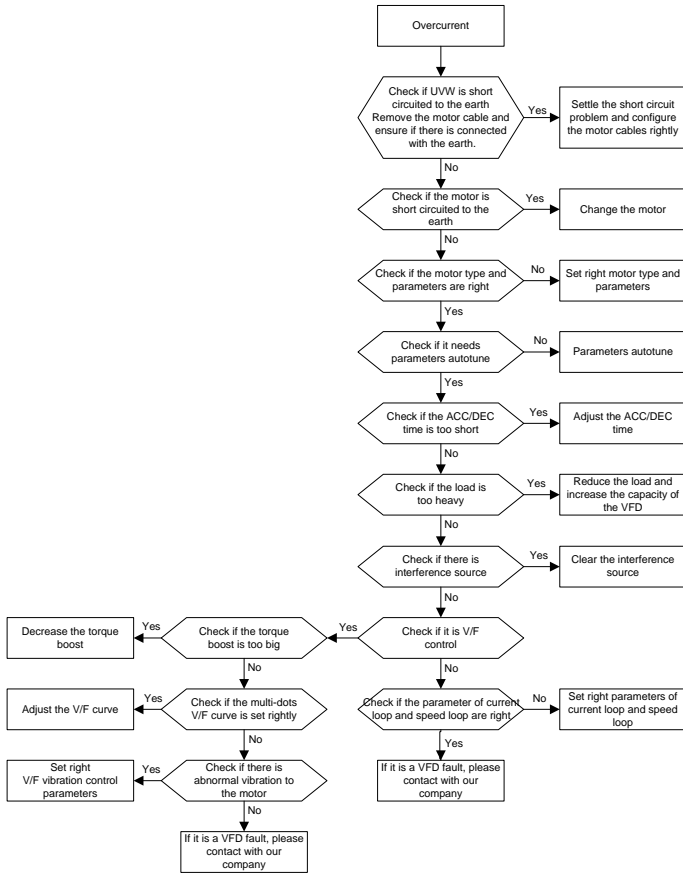

9 Routine maintenance

9.1 What this chapter contains

The chapter contains preventive maintenance instructions of the VFD.

9.2 Maintenance intervals

If installed in an appropriate environment, the VFD requires very little maintenance. The table lists the routine maintenance intervals recommended by INVT.

Checking		Item	Method	Criterion
Ambient environment		Check the ambient temperature, humidity and vibration and ensure there is no dust, gas, oil fog and water drop.	Visual examination and instrument test	Conforming to the manual
		Ensure there are no tools or other foreign or dangerous objects	Visual examination	There are no tools or dangerous objects.
Voltage		Ensure the main circuit and control circuit are normal.	Measurement by millimeter	Conforming to the manual
Keypad		Ensure the display is clear enough	Visual examination	The characters are displayed normally.
		Ensure the characters are displayed totally	Visual examination	Conforming to the manual
Main circuit	For public use	Ensure the screws are tightened firmly	Tighten up	NA
		Ensure there is no distortion, crackles, damage or color-changing caused by overheating and aging to the machine and insulator.	Visual examination	NA
		Ensure there is no dust and dirtiness	Visual examination	NA Note: if the color of the copper blocks change, it does not mean that there is something wrong with the features.

Checking		Item	Method	Criterion
	The lead of the conductors	Ensure that there is no distortion or color-changing of the conductors caused by overheating.	Visual examination	NA
		Ensure that there are no crackles or color-changing of the protective layers.	Visual examination	NA
	Terminals seat	Ensure that there is no damage	Visual examination	NA
	Filter capacitors	Ensure that there is no weeping, color-changing, crackles and cassis expansion.	Visual examination	NA
		Ensure the safety valve is in the right place.	Estimate the usage time according to the maintenance or measure the static capacity.	NA
		If necessary, measure the static capacity.	Measure the capacity by instruments.	The static capacity is above or equal to the original value *0.85.
	Resistors	Ensure whether there is replacement and splitting caused by overheating.	Smelling and visual examination	NA
		Ensure that there is no offline.	Visual examination or remove one ending to coagulate or measure with multimeters	The resistors are in $\pm 10\%$ of the standard value.
	Transformers and reactors	Ensure there is no abnormal vibration, noise and smelling.	Hearing, smelling and visual examination	NA
	Electromagnetism contactors and relays	Ensure whether there is vibration noise in the workroom.	Hearing	NA
		Ensure the contactor is good enough.	Visual examination	NA
	Control	PCB and	Ensure there are no loose screws and contactors.	Fasten up

Checking		Item	Method	Criterion
circuit	plugs	Ensure there is no smelling and color-changing.	Smelling and visual examination	NA
		Ensure there are no crackles, damage distortion and rust.	Visual examination	NA
		Ensure there is no weeping and distortion to the capacitors.	Visual examination or estimate the usage time according to the maintenance information	NA
Cooling system	Cooling fan	Estimate whether there is abnormal noise and vibration.	Hearing and Visual examination or rotate with hand	Stable rotation
		Estimate there is no losses screw.	Tighten up	NA
		Ensure there is no color-changing caused by overheating.	Visual examination or estimate the usage time according to the maintenance information	NA
	Ventilating duct	Ensure whether there is stuff or foreign objection in the cooling fan, air vent.	Visual examination	NA

For more information about the maintenance, contact the local INVT office, or visit the website <http://www.invt.com.cn> of Shenzhen INVT Electric CO., Ltd., choosing **Service and Support** on the homepage to obtain the online service you need.

9.3 Cooling fan

The VFD's cooling fan has a minimum life span of 25,000 operating hours. The actual life span depends on the VFD usage and ambient temperature.

The operating hours can be found through P07.14.

Fan failure can be predicted by the increasing noise from the fan bearings. If the VFD is operated in a critical part of a process, fan replacement is recommended once these symptoms appear. Spare fans are also available.

9.3.1 Replacing the cooling fan

	Read and follow the instructions in Chapter 1 "Safety precautions". Ignoring the instructions would cause physical injury or death, or damage to the equipment.
---	---

1. Stop the VFD and disconnect it from the AC power source and wait for at least the time designated on the VFD.

2. Loosen the fan cable from the clip (remove the shell for the VFDs of 380 V 1.5–30 kW).
3. Disconnect the fan cable.
4. Remove the fan.
5. Install the new fan in the VFD, put the fan cables in the clip and then fix the VFD well. Keep the wind direction of the fan consistent with that of the VFD as shown below:
6. Connect the power supply.

9.4 Capacitors

9.4.1 Capacitors reforming

The DC bus capacitors must be reformed according to the operation instruction if the VFD has been stored for a long time. The storing time is counted from the producing date other than the delivery data which has been marked in the serial number of the VFD.

Time	Operational principle
Storing time less than 1 year	Operation without charging
Storing time 1-2 years	Connect with the power for 1 hour before first ON command
Storing time 2-3 years	Use power surge to charge for the VFD <ul style="list-style-type: none"> • charging 25% rated voltage for 30 minutes • charging 50% rated voltage for 30 minutes • charging 75% rated voltage for 30 minutes • charging 100% rated voltage for 30 minutes
Storing time more than 3 years	Use power surge to charge for the VFD <ul style="list-style-type: none"> • charging 25% rated voltage for 2 hours • charging 50% rated voltage for 2 hours • charging 75% rated voltage for 2 hours • charging 100% rated voltage for 2 hours

Use voltage-adjusting power supply to charge the VFD:

The right selection of the voltage-adjusting power supply depends on the supply power of the VFD. Single phase 220 V AC/2A power surge is applied to the VFD of single/three-phase 220 V AC. The VFD of single/three-phase 220 V AC can apply single phase 220 V AC/2A power surge (L+ to R, N to S or T). All DC bus capacitors can charge at the same time because there is one rectifier.

High-voltage VFD needs enough voltage (for example, 380 V) during charging. The small capacitor power (2A is enough) can be used because the capacitor needs little current when charging.

The operation method of VFD charging through resistors (LEDs):

The charging time is at least 60 minutes if charge the DC bus capacitor directly through supply power. This operation is available on normal temperature and no-load condition and the resistor should be serially connected in the 3-phase circuits of the power supply:

a) 380 V driven device: 1k/100W resistor. LED of 100W can be used when the power voltage is no more than 380 V. But if used, the light may be off or weak during charging.

b) 660 V drive device: 1k/160W resistor.

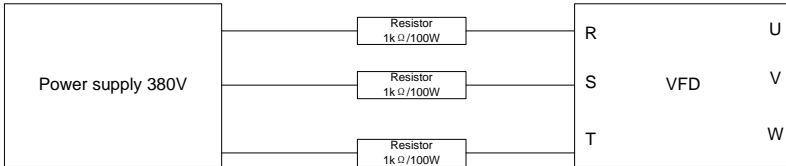

Figure 9-1 380 V charging illustration of the driven device

9.4.2 Change electrolytic capacitors

	Read and follow the instructions in Chapter 1 "Safety precautions". Ignoring the instructions may cause physical injury or death, or damage to the equipment.
--	---

An electrolytic capacitor must be replaced if it has been used for more than 35,000 hours. For details about the replacement, contact the local INVT office, or our national service hotline (400-700-9997).

9.5 Power cable

	Read and follow the instructions in Chapter 1 "Safety precautions". Ignoring the instructions may cause physical injury or death, or damage to the equipment.
--	---

1. Stop the drive and disconnect it from power line. Wait for at least the time designated on the VFD.
2. Check the tightness of the power cable connections.
3. Restore power.

10 Communication protocol

10.1 What this chapter contains

This chapter describes the communication protocol of Goodrive35 series VFDs.

The Goodrive35 series VFDs provide RS485 communication interface. It adopts international standard ModBus communication protocol to perform master-slave communication. The user can realize centralized control through PC/PLC, upper control PC, etc. (set the control command, running frequency of the VFD, modify relevant function codes, monitor and control the operating state and fault information of the VFD and so on) to adapt specific application requirements.

10.2 Brief instruction to Modbus protocol

Modbus is a software protocol, a common language used in electronic controllers. By using this protocol, a controller can communicate with other devices through transmission lines. It is a general industrial standard. With this standard, control devices produced by different manufacturers can be connected to form an industrial network and be monitored in a centralized way.

The Modbus protocol provides two transmission modes, namely American Standard Code for Information Interchange (ASCII) and remote terminal units (RTU). On one Modbus network, all the device transmission modes, baud rates, data bits, check bits, end bits, and other basic parameters must be set consistently.

A Modbus network is a control network with one master and multiple slaves, that is, on one Modbus network, there is only one device serving as the master, and other devices are the slaves. The master can communicate with one slave or broadcast messages to all the slaves. For separate access commands, a slave needs to return a response. For broadcasted information, slaves do not need to return responses.

10.3 Application of the VFD

The Modbus protocol of the VFD is RTU mode and the physical layer is RS485.

10.3.1 RS485

The interface of RS485 works on semiduplex and its data signal applies differential transmission which is called balance transmission, too. It uses twisted pairs, one of which is defined as A (+) and the other is defined as B (-). Generally, if the positive electrical level between sending drive A and B is among +2—+6 V, it is logic"1", if the electrical level is among -2 V—-6 V, it is logic"0".

485+ on the terminal board corresponds to A and 485- to B.

Communication baud rate means the binary bit number in one second. The unit is bit/s (bps). Higher the baud rate is, quicker the transmission speed is, and weaker the anti-interference is. If twisted pair of 0.56mm (24AWG) is used as communication cable, the max transmission distance is as below:

Baud rate	Max transmission distance	Baud rate	Max transmission distance
2400BPS	1800m	9600BPS	800m
4800BPS	1200m	19200BPS	600m

It is recommended to use shield cables and make the shield layer as the grounding wires during RS485 remote communication.

In the cases with less devices and shorter distance, it is recommended to use 120Ω terminal resistor as the performance will be weakened if the distance increases even if the network can perform well without load resistor.

10.3.1.1 Single application

Figure 10-1 is the site Modbus connection figure of single VFD and PC. Generally, the computer does not have RS485 interface, the RS232 or USB interface of the computer should be converted into RS485 by converter. Connect the A terminal of RS485 to the 485+ terminal of the VFD and B to the 485- terminal. It is recommended to use the shield twisted pairs. When applying RS232-RS485 converter, if the RS232 interface of the computer is connected to the RS232 interface of the converter, the wire length should be as short as possible within the length of 15m. It is recommended to connect the RS232-RS485 converter to the computer directly. If using USB-RS485 converter, the wire should be as short as possible, too.

Select a right interface to the upper monitor of the computer (select the interface of RS232-RS485 converter, such as COM1) after the wiring and set the basic parameters such as communication baud rate and digital check bit to the same as the VFD.

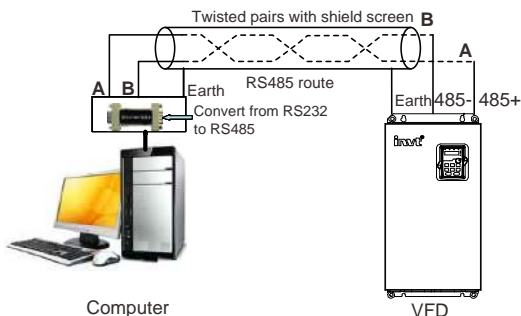

Figure 10-1 RS485 physical connection in single application

10.3.1.2 Multi-application

In the real multi-application, the chrysanthemum connection and star connection are commonly used.

Chrysanthemum chain connection is required in the RS485 industrial fieldbus standards. The two ends are connected to terminal resistors of 120Ω which is shown as Figure 10-2. Figure 10-3 is the simply connection figure and Figure 10-4 is the real application figure.

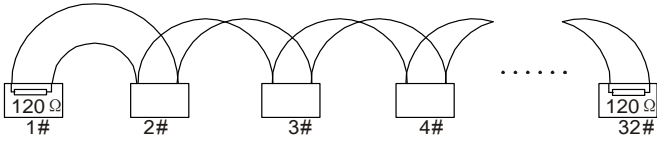

Figure 10-2 Chrysanthemum connection

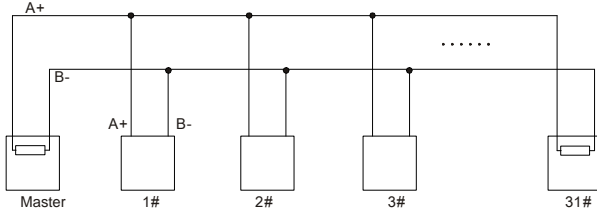

Figure 10-3 Chrysanthemum connection

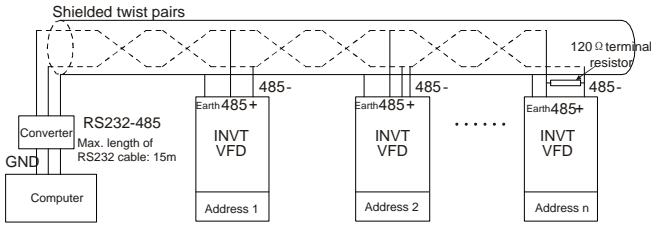

Figure 10-4 Chrysanthemum connection applications

Figure 10-5 is the star connection. Terminal resistor should be connected to the two devices which have the longest distance. (1# and 15#device)

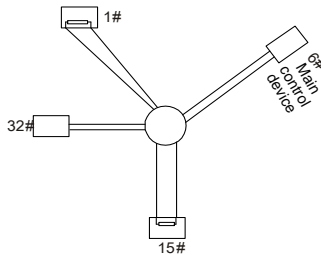

Figure 10-5 Star connection

It is recommended to use shield cables in multiple connection. The basic parameter of the devices, such as baud rate and digital check bit in RS485 should be the same and there should be no repeated address.

10.3.2 RTU mode

10.3.2.1 RTU communication frame format

If the controller is set to communicate by RTU mode in Modbus network every 8bit byte in the message includes two 4Bit hex characters. Compared with ACSII mode, this mode can send more data at the same baud rate.

Code system

1 start bit

7 or 8 digital bit, the minimum valid bit can be sent firstly. Every 8 bit frame includes two hex characters (0...9, A...F)

1 even/odd check bit. If there is no checkout, the even/odd check bit is inexistent.

1 end bit (with checkout), 2 bit (no checkout)

Error detection field

CRC

The data format is illustrated as below:

11-bit character frame (BIT1–BIT8 are the data bits)

Start bit	BIT1	BIT2	BIT3	BIT4	BIT5	BIT6	BIT7	BIT8	Check bit	End bit
-----------	------	------	------	------	------	------	------	------	-----------	---------

10-bit character frame (BIT1–BIT7 are the data bits)

Start bit	BIT1	BIT2	BIT3	BIT4	BIT5	BIT6	BIT7	Check bit	End bit
-----------	------	------	------	------	------	------	------	-----------	---------

In a character frame, only the data bits carry information. The start bit, check bit, and end bit are used to facilitate the transmission of the data bits to the destination device. In practical applications, you must set the data bits, parity check bits, and end bits consistently.

In RTU mode, the transmission of a new frame always starts from an idle time (the transmission time of 3.5 bytes). On a network where the transmission rate is calculated based on the baud rate, the transmission time of 3.5 bytes can be easily obtained. After the idle time ends, the data domains are transmitted in the following sequence: slave address, operation command code, data, and CRC check character. Each byte transmitted in each domain includes 2 hexadecimal characters (0–9, A–F). The network devices always monitor the communication bus. After receiving the first domain (address information), each network device identifies the byte. After the last byte is transmitted, a similar transmission interval (the transmission time of 3.5 bytes) is used to indicate that the transmission of the frame ends. Then, the transmission of a new frame starts.

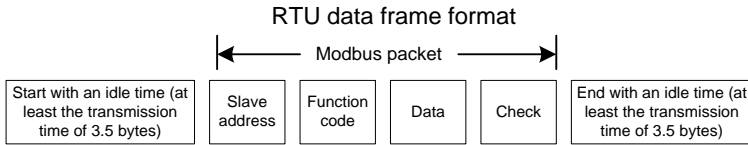

The information of a frame must be transmitted in a continuous data flow. If there is an interval greater than the transmission time of 1.5 bytes before the transmission of the entire frame is complete, the receiving device deletes the incomplete information, and mistakes the subsequent byte for the address domain of a new frame. Similarly, if the transmission interval between two frames is shorter than the transmission time of 3.5 bytes, the receiving device mistakes it for the data of the last frame. The CRC check value is incorrect due to the disorder of the frames, and thus a communication fault occurs.

The standard structure of RTU frame:

START	T1-T2-T3-T4 (transmission time of 3.5 bytes)
ADDR	Communication address: 0–247 (decimal system) (0 is the broadcast address)
CMD	03H: read slave parameters 06H: write slave parameters
DATA (N-1) ... DATA (0)	The data of 2*N bytes are the main content of the communication as well as the core of data exchanging
CRC CHK LSB	Detection value: CRC (16BIT)
CRC CHK MSB	
END	T1-T2-T3-T4 (transmission time of 3.5 bytes)

10.3.2.2 RTU communication frame error checkout

During the transmission of data, errors may occur due to various factors. Without check, the data receiving device cannot identify data errors and may make a wrong response. The wrong response may cause severe problems. Therefore, the data must be checked.

The check is implemented as follows: The transmitter calculates the to-be-transmitted data based on a specific algorithm to obtain a result, adds the result to the rear of the message, and transmits them together. After receiving the message, the receiver calculates the data based on the same algorithm to obtain a result, and compares the result with that transmitted by the transmitter. If the results are the same, the message is correct. Otherwise, the message is considered wrong.

The error check of a frame includes two parts, namely, bit check on individual bytes (that is, odd/even check using the check bit in the character frame), and whole data check (CRC check).

Bit check on individual bytes (odd/even check)

You can select the bit check mode as required, or you can choose not to perform the check, which will affect the check bit setting of each byte.

Definition of even check: Before the data is transmitted, an even check bit is added to indicate whether the number of "1" in the to-be-transmitted data is odd or even. If it is even, the check bit is set to "0"; and if it is odd, the check bit is set to "1".

Definition of odd check: Before the data is transmitted, an odd check bit is added to indicate whether the number of "1" in the to-be-transmitted data is odd or even. If it is odd, the check bit is set to "0"; and if it is even, the check bit is set to "1".

For example, the data bits to be transmitted are "11001110", including five "1". If the even check is applied, the even check bit is set to "1"; and if the odd check is applied, the odd check bit is set to "0". During the transmission of the data, the odd/even check bit is calculated and placed in the check bit of the frame. The receiving device performs the odd/even check after receiving the data. If it finds that the odd/even parity of the data is inconsistent with the preset information, it determines that a communication error occurs.

CRC check

A frame in the RTU format includes an error detection domain based on the CRC calculation. The CRC domain checks all the content of the frame. The CRC domain consists of two bytes, including 16 binary bits. It is calculated by the transmitter and added to the frame. The receiver calculates the CRC of the received frame, and compares the result with the value in the received CRC domain. If the two CRC values are not equal to each other, errors occur in the transmission.

During CRC, 0xFFFF is stored first, and then a process is invoked to process a minimum of 6 contiguous bytes in the frame based on the content in the current register. CRC is valid only for the 8-bit data in each character. It is invalid for the start, end, and check bits.

During the generation of the CRC values, the "exclusive or" (XOR) operation is performed on the each 8-bit character and the content in the register. The result is placed in the bits from the least significant bit (LSB) to the most significant bit (MSB), and 0 is placed in the MSB. Then, LSB is detected. If LSB is 1, the XOR operation is performed on the current value in the register and the preset value. If LSB is 0, no operation is performed. This process is repeated 8 times. After the last bit (8th bit) is detected and processed, the XOR operation is performed on the next 8-bit byte and the current content in the register. The final values in the register are the CRC values obtained after operations are performed on all the bytes in the frame.

The calculation adopts the international standard CRC check rule. You can refer to the related standard CRC algorithm to compile the CRC calculation program as required.

The following is a simple CRC calculation function for your reference (using the C programming language):

```
unsigned int   crc_cal_value(unsigned char*data_value,unsigned char
data_length)
{
    int i;
```

```

unsigned int crc_value=0xffff;
while(data_length--)
{
    crc_value^=*data_value++;
    for(i=0;i<8;i++)
    {
        if(crc_value&0x0001)
            crc_value=(crc_value>>1)^0xa001;
        else
            crc_value=crc_value>>1;
    }
}
return(crc_value);
}

```

In the ladder logic, CKSM uses the table look-up method to calculate the CRC value according to the content in the frame. The program of this method is simple, and the calculation is fast, but the ROM space occupied is large. Use this program with caution in scenarios where there are space occupation limits on programs.

10.4 RTU command code and communication data illustration

10.4.1 Command code: 03H, reading N words (continuously reading up to 16 words)

The command code 03H is used by the master to read data from the VFD. The quantity of data to be read depends on the "data quantity" in the command. A maximum of 16 pieces of data can be read. The addresses of the read parameters must be contiguous. Each piece of data occupies 2 bytes, that is, one word. The command format is presented using the hexadecimal system (a number followed by "H" indicates a hexadecimal value). One hexadecimal value occupies one byte.

The 03H command is used to read information including the parameters and operation state of the VFD.

For example, starting from the data address of 0004H, to read two contiguous pieces of data (that is, to read content from the data addresses 0004H and 0005H), the structure of the frame is described in the following table.

RTU master command (transmitted by the master to the VFD)

START	T1-T2-T3-T4 (transmission time of 3.5 bytes)
ADDR (address)	01H
CMD (command code)	03H
Most significant byte (MSB) of the start address	00H
Least significant byte (LSB) of	04H

the start address	
MSB of data quantity	00H
LSB of data quantity	02H
LSB of CRC	85H
MSB of CRC	CAH
END	T1-T2-T3-T4 (transmission time of 3.5 bytes)

The value in START and END is "T1-T2-T3-T4 (transmission time of 3.5 bytes)", indicating that the RS485 needs to stay idle for at least the transmission time of 3.5 bytes. An idle time is required to distinguish on message from another to ensure that the two messages are not regarded as one.

The value of ADDR is 01H, indicating that the command is transmitted to the VFD whose address is 01H. The ADDR information occupies one byte.

The value of CMD is 03H, indicating that the command is used to read data from the VFD. The CMD information occupies one byte.

"Start address" indicates that data reading is started from this address. It occupies two bytes, with the MSB on the left and LSB on the right.

"Data quantity" indicates the quantity of data to be read (unit: word).

The value of "Start address" is 0004H, and that of "Data quantity" is 0002H, indicating that data is to be read from the data addresses of 0004H and 0005H.

CRC check occupies two bytes, with the LSB on the left, and MSB on the right.

RTU slave response (transmitted by the VFD to the master)

START	T1-T2-T3-T4 (transmission time of 3.5 bytes)
ADDR	01H
CMD	03H
Number of bytes	04H
MSB of data in 0004H	13H
LSB of data in 0004H	88H
MSB of data in 0005H	00H
LSB of data in 0005H	00H
LSB of CRC	7EH
MSB of CRC	9DH
END	T1-T2-T3-T4 (transmission time of 3.5 bytes)

The definition of the response information is described as follows:

The value of ADDR is 01H, indicating that the message is transmitted by the VFD whose address is 01H. The ADDR information occupies one byte.

The value of CMD is 03H, indicating that the message is a response of the VFD to the 03H command

of the master for reading data. The CMD information occupies one byte.

"Number of bytes" indicates the number of bytes between a byte (not included) and the CRC byte (not included). The value 04 indicates that there are four bytes of data between "Number of bytes" and "LSB of CRC", that is, "MSB of data in 0004H", "LSB of data in 0004H", "MSB of data in 0005H", and "LSB of data in 0005H".

A piece of data is two bytes, with the MSB on the left and LSB on the right. From the response, we can see that the data in 0004H is 1388H, and that in 0005H is 0000H.

CRC check occupies two bytes, with the LSB on the left, and MSB on the right.

10.4.2 Command code: 06H, writing a word

This command is used by the master to write data to the VFD. One command can be used to write only one piece of data. It is used to modify the parameters and operation mode of the VFD.

For example, to write 5000 (1388H) to 0004H of the VFD whose address is 02H, the structure of the frame is described in the following table.

RTU master command (transmitted by the master to the VFD)

START	T1-T2-T3-T4 (transmission time of 3.5 bytes)
ADDR	02H
CMD	06H
MSB of data writing address	00H
LSB of data writing address	04H
MSB of to-be-written data	13H
LSB of to-be-written data	88H
LSB of CRC	C5H
MSB of CRC	6EH
END	T1-T2-T3-T4 (transmission time of 3.5 bytes)

RTU slave response (transmitted by the VFD to the master)

START	T1-T2-T3-T4 (transmission time of 3.5 bytes)
ADDR	02H
CMD	06H
MSB of data writing address	00H
LSB of data writing address	04H
MSB of to-be-written data	13H
LSB of to-be-written data	88H
LSB of CRC	C5H
MSB of CRC	6EH
END	T1-T2-T3-T4 (transmission time of 3.5 bytes)

Note: Section 10.4.1 and 10.4.2 mainly describe the command format, and the detailed application will be mentioned in 10.4.3 with examples.

10.4.3 Command code: 08H, diagnosis

Sub-function code description

Sub-function Code	Description
0000	Return data based on query requests

For example, to query about the circuit detection information about the VFD whose address is 01H, the query and return strings are the same, and the format is described in the following tables.

RTU master command

START	T1-T2-T3-T4 (transmission time of 3.5 bytes)
ADDR	01H
CMD	08H
MSB of the sub-function code	00H
LSB of the sub-function code	00H
MSB of data	12H
LSB of data	ABH
LSB of CRC CHK	ADH
MSB of CRC CHK	14H
END	T1-T2-T3-T4 (transmission time of 3.5 bytes)

RTU slave response

START	T1-T2-T3-T4 (transmission time of 3.5 bytes)
ADDR	01H
CMD	08H
MSB of the sub-function code	00H
LSB of the sub-function code	00H
MSB of data	12H
LSB of data	ABH
LSB of CRC CHK	ADH
MSB of CRC CHK	14H
END	T1-T2-T3-T4 (transmission time of 3.5 bytes)

10.4.4 Command code: 10H, continuous writing

The command code 10H is used by the master to write data to the VFD. The quantity of data to be written is determined by "Data quantity", and a maximum of 16 pieces of data can be written.

For example, to write 5000 (1388H) and 50 (0032H) respectively to 0004H and 0005H of the VFD whose slave address is 02H, the structure of the frame is described in the following table.

RTU master command (transmitted by the master to the VFD)

START	T1-T2-T3-T4 (transmission time of 3.5 bytes)
ADDR	02H
CMD	10H
MSB of data writing address	00H
LSB of data writing address	04H
MSB of data quantity	00H
LSB of data quantity	02H
Number of bytes	04H
MSB of data to be written to 0004H	13H
LSB of data to be written to 0004H	88H
MSB of data to be written to 0005H	00H
LSB of data to be written to 0005H	32H
LSB of CRC	C5H
MSB of CRC	6EH
END	T1-T2-T3-T4 (transmission time of 3.5 bytes)

RTU slave response (transmitted by the VFD to the master)

START	T1-T2-T3-T4 (transmission time of 3.5 bytes)
ADDR	02H
CMD	10H
MSB of data writing address	00H
LSB of data writing address	04H
MSB of data quantity	00H
LSB of data quantity	02H
LSB of CRC	C5H
MSB of CRC	6EH
END	T1-T2-T3-T4 (transmission time of 3.5 bytes)

10.4.5 The definition of data address

This section describes the address definition of communication data. The addresses are used for controlling the running, obtaining the state information, and setting related function parameters of the VFD.

10.4.5.1 The rules of parameter address of the function codes

The address of a function code consists of two bytes, with the MSB on the left and LSB on the right. The MSB ranges from 00 to ffH, and the LSB also ranges from 00 to ffH. The MSB is the hexadecimal form of the group number before the dot mark, and LSB is that of the number behind the dot mark. Take P05.06 as an example, the group number is 05, that is, the MSB of the parameter address is the hexadecimal form of 05; and the number behind the dot mark is 06, that is, the LSB is the hexadecimal

form of 06. Therefore, the function code address is 0506H in the hexadecimal form. For P10.01, the parameter address is 0A01H.

Function code	Name	Description	Default	Modify
P10.00	Simple PLC	0: Stop after running once. 1: Run at the final value after running once. 2. Cycle running.	0	○
P10.01	Simple PLC memory selection	0: Power loss without memory 1: Power loss with memory	0	○

Note:

The parameters in the P29 group are set by the manufacturer. They cannot be read or modified. Some parameters cannot be modified when the VFD is running; some cannot be modified regardless of the state of the VFD. Pay attention to the setting range, unit, and related description of a parameter when modifying it.

The service life of the Electrically Erasable Programmable Read-Only Memory (EEPROM) may be reduced if it is frequently used for storage. For users, some function codes do not need to be stored during communication. The application requirements can be met by modifying the value of the on-chip RAM, that is, modifying the MSB of the corresponding function code address from 0 to 1. For example, if P00.07 is not to be stored in the EEPROM, you need only to modify the value of the RAM, that is, set the address to 8007H. The address can be used only for writing data to the on-chip RAM, and it is invalid when used for reading data.

10.4.5.2 The address instruction of other function in Modbus

In addition to modifying the parameters of the VFD, the master can also control the VFD, such as start and stop it, and monitor the operation state of the VFD.

The following table describes other function parameters.

Function	Address	Data description	R/W
Communication-based control command	2000H	0001H: Forward running	R/W
		0002H: Reverse running	
		0003H: Forward jogging	
		0004H: Reverse jogging	
		0005H: Stop	
		0006H: Coast to stop	
		0007H: Fault reset	
		0008H: Jogging to stop	
Communication-based value setting	2001H	Communication-based frequency setting (0–Fmax, unit: 0.01 Hz)	R/W
	2002H	PID setting, range (0–1000, 1000 corresponding to 100.0%)	

Function	Address	Data description	R/W
	2003H	PID feedback, range (0–1000, 1000 corresponding to 100.0%)	R/W
	2004H	Torque setting (-3000→+3000, 1000 corresponding to 100.0% of the rated current of the motor)	R/W
	2005H	Setting of the upper limit of the forward running frequency (0–Fmax, unit: 0.01 Hz)	R/W
	2006H	Setting of the upper limit of the reverse running frequency (0–Fmax, unit: 0.01 Hz)	R/W
	2007H	Upper limit of the electromotion torque (0–3000, 1000 corresponding to 100.0% of the rated current of the VFD)	R/W
	2008H	Upper limit of the braking torque (0–3000, 1000 corresponding to 100.0% of the rated current of the motor)	R/W
	2009H	Special control command word: Bit0–1: =00: Motor 1 =01: Motor 2 =10: Motor 3 =11: Motor 4 Bit2: =1 Torque control disabled =0: Torque control cannot be disabled Bit3: =1 Power consumption reset to 0 =0: Power consumption not reset Bit4: =1 Pre-excitation =0: Pre-excitation disabled Bit5: =1 DC braking =0: DC braking disabled	R/W
	200AH	Virtual input terminal command, range: 0x000–0x1FF	R/W
	200BH	Virtual output terminal command, range: 0x00–0x0F	R/W
	200CH	Voltage setting (used when V/F separation is implemented) (0–1000, 1000 corresponding to 100.0% of the rated voltage of the motor)	R/W
	200DH	AO output setting 1 (-1000→+1000, 1000 corresponding to 100.0%)	R/W
	200EH	AO output setting 2 (-1000→+1000, 1000 corresponding to 100.0%)	R/W
VFD state word 1	2100H	0001H: Forward running 0002H: Reverse running	R

Function	Address	Data description	R/W
		0003H: Stopped	
		0004H: Faulty	
		0005H: POFF	
		0006H: Pre-excited	
VFD state word 2	2101H	Bit0: =0: Not ready to run =1: Ready to run Bi1-2: =00: Motor 1 =01: Motor 2 =10: Motor 3 =11: Motor 4 Bit3: =0: Asynchronous machine =1: Synchronous machine Bit4: =0: No overload alarm =1: Overload alarm Bit5–Bit6: =00: Keypad-based control =01: Terminal-based control =10: Communication-based control	R
VFD fault code	2102H	See the description of fault types.	R
VFD identification code	2103H	GD35----0x0109	R
Running frequency	3000H	0–Fmax (unit: 0.01Hz)	Compatible with CHF100A and CHV100 communication addresses
Set frequency	3001H	0–Fmax (unit: 0.01Hz)	
Bus voltage	3002H	0.0–2000.0 V (unit: 0.1V)	
Output voltage	3003H	0–1200V (unit: 1V)	
Output current	3004H	0.0–3000.0A (unit: 0.1A)	
Rotating speed	3005H	0–65535 (unit: 1RPM)	
Output power	3006H	-300.0–+300.0% (unit: 0.1%)	
Output torque	3007H	-250.0–+250.0% (unit: 0.1%)	
Closed-loop setting	3008H	-100.0–+100.0% (unit: 0.1%)	
Closed-loop feedback	3009H	-100.0–+100.0% (unit: 0.1%)	
Input state	300AH	000–1FF	
Output state	300BH	000–1FF	
Analog input 1	300CH	0.00–10.00V (unit: 0.01V)	
Analog input 2	300DH	0.00–10.00V (unit: 0.01V)	
Analog input 3	300EH	-10.00–10.00V (unit: 0.01V)	
Analog input 4	300FH		
Read input of high-speed pulse 1	3010H	0.00–50.00kHz (unit: 0.01Hz)	
Read input of high-speed pulse 2	3011H		
Read current step of multi-step speed	3012H	0–15	

Function	Address	Data description	R/W
External length	3013H	0–65535	R
External count value	3014H	0–65535	R
Torque setting	3015H	-300.0–+300.0% (unit: 0.1%)	R
Identification code	3016H		R
Fault code	5000H		R

The Read/Write (R/W) characteristics indicate whether a function can be read and written. For example, "Communication-based control command" can be written, and therefore the command code 6H is used to control the VFD. The R characteristic indicates that a function can only be read, and W indicates that a function can only be written.

Note: Some parameters in the preceding table are valid only after they are enabled. Take the running and stop operations as examples, you need to set "Running command channel" (P00.01) to "Communication", and set "Communication running command channel" (P00.02) to the Modbus communication channel. For another example, when modifying "PID setting", you need to set "PID reference source" (P09.00) to Modbus communication.

The following table describes the encoding rules of device codes (corresponding to the identification code 2103H of the VFD).

MSB of the code	Meaning	LSB of the code	Meaning
0x01	GD	0x09	GD35 vector VFD
		0x0a	GD300 vector VFD

10.4.6 Fieldbus ratio values

In practical applications, communication data is represented in the hexadecimal form, but hexadecimal values cannot represent decimals. For example, 50.12 Hz cannot be represented in the hexadecimal form. In such cases, we can multiply 50.12 by 100 to obtain an integer 5012, and then 50.12 can be represented as 1394H (5012 in the decimal form) in the hexadecimal form.

In the process of multiplying a non-integer by a multiple to obtain an integer, the multiple is referred to as a fieldbus scale.

The fieldbus scale depends on the number of decimals in the value specified in "Detailed parameter description" or "Default value". If there are n decimals in the value, the fieldbus scale m is the n^{th} -power of 10. Take the following table as an example, m is 10.

Function code	Name	Description	Default	Modify
P01.20	Hibernation restore delay time	0.0–3600.0s (valid when P01.19 is 2)	0.0s	○

Function code	Name	Description	Default	Modify
P01.21	Restart after power off	0: Restart is disabled 1: Restart is enabled	0	○

The value specified in "Detailed parameter description" or "Default value" contains one decimal, so the fieldbus scale is 10. If the value received by the upper computer is 50, the value of "Wake-up-from-sleep delay" of the VFD is 5.0 (5.0=50/10).

To set the "Wake-up-from-sleep delay" to 5.0s through Modbus communication, you need first to multiply 5.0 by 10 according to the scale to obtain an integer 50, that is, 32H in the hexadecimal form, and then transmit the following write command:

01 06 01 14 00 32 49 E7
VFD Write Parameter Parameter CRC check
address command address data

After receiving the command, the VFD converts 50 into 5.0 based on the fieldbus scale, and then sets "Wake-up-from-sleep delay" to 5.0s.

For another example, after the upper computer transmits the "Wake-up-from-sleep delay" parameter read command, the master receives the following response from the VFD:

01 03 02 00 32 39 91
VFD Read 2-byte Parameter CRC check
address command data data

The parameter data is 0032H, that is, 50, so 5.0 is obtained based on the fieldbus scale (50/10=5.0). In this case, the master identifies that the "Wake-up-from-sleep delay" is 5.0s.

10.4.7 Fault message response

Operation errors may occur in communication-based control. For example, some parameters can only be read, but a write command is transmitted. In this case, the VFD returns an error message response.

Error message responses are transmitted by the VFD to the master. The following table describes the codes and definitions of the error message responses.

Code	Name	Definition
01H	Invalid command	The command code received by the upper computer is not allowed to be executed. The possible causes are as follows: <ul style="list-style-type: none"> The function code is applicable only on new devices and is not implemented on this device. The slave is in the faulty state when processing this request.
02H	Invalid data address	For the VFD, the data address in the request of the upper computer is not allowed. In particular, the combination of the register address

Code	Name	Definition
		and the number of the to-be-transmitted bytes is invalid.
03H	Invalid data bit	The received data domain contains a value that is not allowed. The value indicates the error of the remaining structure in the combined request. Note: It does not mean that the data item submitted for storage in the register includes a value unexpected by the program.
04H	Operation failure	The parameter is set to an invalid value in the write operation. For example, a function input terminal cannot be set repeatedly.
05H	Password error	The password entered in the password verification address is different from that set in P07.00.
06H	Data frame error	The length of the data frame transmitted by the upper computer is incorrect, or in the RTU format, the value of the CRC check bit is inconsistent with the CRC value calculated by the lower computer
07H	Parameter read-only	The parameter to be modified in the write operation of the upper computer is a read-only parameter.
08H	Parameter cannot be modified in running	The parameter to be modified in the write operation of the upper computer cannot be modified during the running of the VFD.
09H	Password protection	A user password is set, and the upper computer does not provide the password to unlock the system when performing a read or write operation. The error of "system locked" is reported.

When returning a response, the device uses a function code domain and fault address to indicate whether it is a normal response (no error) or exception response (some errors occur). In a normal response, the device returns the corresponding function code and data address or sub-function code. In an exception response, the device returns a code that is equal to a normal code, but the first bit is logic 1.

For example, if the master device transmits a request message to a slave device for reading a group of function code address data, the code is generated as follows:

0 0 0 0 0 1 1 (03H in the hexadecimal form)

For a normal response, the same code is returned. For an exception response, the following code is returned:

1 0 0 0 0 1 1 (83H in the hexadecimal form)

In addition to the modification of the code, the slave returns a byte of exception code that describes the cause of the exception. After receiving the exception response, the typical processing of the master device is to transmit the request message again or modify the command based on the fault

information.

For example, to set the "Running command channel" (P00.01, the parameter address is 0001H) of the VFD whose address is 01H to 03, the command is as follows:

<u>01</u>	<u>06</u>	<u>00 01</u>	<u>00 03</u>	<u>98 0B</u>
VFD address	Write command	Parameter address	Parameter data	CRC check

But the setting range of the "Running command channel" is 0 to 2. The value 3 exceeds the setting range. In this case, the VFD returns an error message response as shown in the following:

<u>01</u>	<u>86</u>	<u>04</u>	<u>43 A3</u>
VFD address	Exception response code	Error code	CRC check

The exception response code 86H (generated based on the MSB "1" of the write command 06H) indicates that it is an exception response to the write command (06H). The error code is 04H. From the preceding table, we can see that it indicates the error "Operation failure", which means "The parameter is set to an invalid value in the write operation".

10.4.8 Example of writing and reading

For details about the formats of the read and write commands, see sections 10.4.1 and 10.4.2.

10.4.8.1 Example of reading command 03H

Example 1: Read state word 1 of the VFD whose address is 01H. From the table of other function parameters, we can see that the parameter address of state word 1 of the VFD is 2100H.

The read command transmitted to the VFD is as follows:

<u>01</u>	<u>03</u>	<u>21 00</u>	<u>00 01</u>	<u>8E 36</u>
VFD address	Read command	Parameter address	Data quantity	CRC check

Assume that the following response is returned:

<u>01</u>	<u>03</u>	<u>02</u>	<u>00 03</u>	<u>F8 45</u>
VFD address	Read command	Number of bytes	Data content	CRC check

The data content returned by the VFD is 0003H, which indicates that the VFD is in the stopped state.

Example 2: View information about the VFD whose address is 03H, including "Type of current fault" (P07.27) to "Type of last but four fault" (P07.32) of which the parameter addresses are 071BH to 0720H (contiguous 6 parameter addresses starting from 071BH).

The command transmitted to the VFD is as follows:

03 **03** **07 1B** **00 06** **B5 59**
 VFD Read Start 6 parameters in total CRC check
 address command address

Assume that the following response is returned:

03 **03** **0C** **00 23** **00 23** **00 23** **00 23** **00 23** **00 23** **00 23** **5F D2**
 VFD Read Number of Type of Type of Type of last Type of last Type of last Type of last Type of last CRC check
 address command bytes of current fault of last fault but one fault but two fault but three fault but four fault

From the returned data, we can see that all the fault types are 0023H, that is, 35 in the decimal form, which means the maladjustment fault (STo).

10.4.8.2 Example of writing command 06H

Example 1: Set the VFD whose address is 03H to be forward running. Refer to the table of other function parameters, the address of "Communication-based control command" is 2000H, and 0001H indicates forward running, as shown in the following figure.

Function	Address	Data description	R/W
Communication-based control command	2000H	0001H: Forward running	R/W
		0002H: Reverse running	
		0003H: Forward jogging	
		0004H: Reverse jogging	
		0005H: Stop	
		0006H: Coast to stop (emergency stop)	
		0007H: Fault reset	
		0008H: Jogging to stop	

The command transmitted by the master is as follows:

03 **06** **20 00** **00 01** **42 28**
 VFD Write Parameter Forward CRC
 address command address running check

If the operation is successful, the following response is returned (same as the command transmitted by the master):

03 **06** **20 00** **00 01** **42 28**
 VFD Write Parameter Forward CRC
 address command address running check

Example 2: Set the "Max. output frequency" of the VFD whose address is 03H to 100 Hz.

Function code	Name	Detailed parameter description	Default value	Modify
P00.03	Max. output	Setting range: P00.04–400.00 Hz	50.00Hz	☉

Function code	Name	Detailed parameter description	Default value	Modify
	frequency			

From the number of decimals, we can see that the fieldbus scale of the "Max. output frequency" (P00.03) is 100. Multiply 100 Hz by 100. The value 10000 is obtained, and it is 2710H in the hexadecimal form.

The command transmitted by the master is as follows:

03 **06** **00 03** **27 10** **62 14**
 VFD Write Parameter Parameter CRC check
 address command address data

If the operation is successful, the following response is returned (same as the command transmitted by the master):

03 **06** **00 03** **27 10** **62 14**
 VFD Write Parameter Parameter CRC check
 address command address data

Note: In the preceding command description, spaces are added to a command just for explanatory purposes. In practical applications, no space is required in the commands.

10.4.8.3 Example of continuous writing command10H

Example 1: make the VFD whose address is 01H run forward at 10 Hz. Refer to the instruction of 2000H and 0001. Set the address of "communication setting frequency" is 2001H and 10 Hz corresponds to 03E8H. See the table below.

Example 1: Set the VFD whose address is 01H to be forward running at the frequency of 10 Hz. Refer to the table of other function parameters, the address of "Communication-based control command" is 2000H, 0001H indicates forward running, and the address of "Communication-based value setting" is 2001H, as shown in the following figure. 10 Hz is 03E8H in the hexadecimal form.

Function instruction	Address definition	Data meaning instruction	R/W characteristics
Communication-based control command	2000H	0001H: Forward running	R/W
		0002H: Reverse running	
		0003H: Forward jogging	
		0004H: Reverse jogging	
		0005H: Stop	
		0006H: Coast to stop (emergency stop)	
		0007H: Fault reset	
		0008H: Jogging to stop	
Communication-based	2001H	Communication-based frequency	R/W

Function instruction	Address definition	Data meaning instruction	R/W characteristics
value setting		setting (0–Fmax, unit: 0.01 Hz)	
	2002H	PID setting, range (0–1000, 1000 corresponding to 100.0%)	

In the actual operation, set P00.01 to 2 and P00.06 to 8.

The command transmitted by the master is as follows:

01 **10** **20 00** **00 02** **04** **00 01** **03 E8** **3B 10**
 VFD Continuous Parameter Data Number Forward Froward 10 Hz CRC check
 address write address quantity bytes running

If the operation is successful, the following response is returned:

01 **10** **20 00** **00 02** **4A 08**
 VFD Continuous Parameter Data CRC
 address write address quantity check
 command

Example 2: Set "Acceleration time" of the VFD whose address is 01H to 10s, and "Deceleration time" to 20s.

Function code	Name	Detailed parameter description	Default value	Modify
P00.11	ACC time 1	Setting range of P00.11 and P00.12: 0.0–3600.0 s	Depend on model	<input type="radio"/>
P00.12	DEC time 1		Depend on model	<input type="radio"/>

The address of P00.11 is 000B, ACC time of 10s is 0064H in the hexadecimal form, and the DEC time of 20s is 00C8H in the hexadecimal form.

The command transmitted by the master is as follows:

01 **10** **00 0B** **00 02** **04** **00 64** **00 C8** **F2 55**
 VFD Continuous Parameter Data Number 10 s 20 s CRC check
 address write address quantity bytes

If the operation is successful, the following response is returned:

01 **10** **00 0B** **00 02** **30 0A**
 VFD Continuous Parameter Data CRC
 address write address quantity check
 command

Note: In the preceding command description, spaces are added to a command just for explanatory purposes. In practical applications, no space is required in the commands.

10.4.8.4 Modbus communication debugging instance

A PC is used as the host, an RS232-RS485 converter is used for signal conversion, and the PC serial port used by the converter is COM1 (an RS232 port). The upper computer commissioning software is the serial port commissioning assistant Commix, which can be downloaded from the Internet. Download a version that can automatically execute the CRC check function. The following figure shows the interface of Commix.

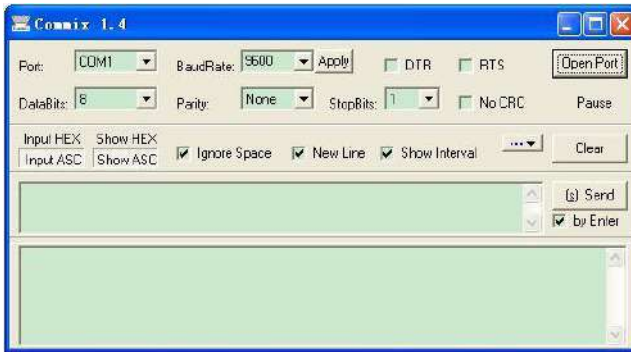

First, select COM1 for "serial port" and the baud rate should be set to the same value with P14.01. The data bit, check bit and stop bit must be consistent with the setup in P14.02. As RTU mode is used here, "HEX" should be selected. Check ModbusRTU to make the software add CRC automatically, and select CRC16 (ModbusRTU) with the starting byte being 1. Once enabled, CRC check will be added automatically, which removes the need to fill in CRC manually.

The commissioning command to set the VFD whose address is 03H to be forward running is as follows:

<u>03</u>	<u>06</u>	<u>20 00</u>	<u>00 01</u>	<u>42 28</u>
VFD address	Write command	Parameter address	Forward running	CRC check

Note:

- ✧ Set the address (P14.00) of the VFD to 03.
- ✧ Set "Channel of running commands" (P00.01) to "Communication", and set "Communication channel of running commands" (P00.02) to the Modbus communication channel.
- ✧ Click Send. If the line configuration and settings are correct, a response transmitted by the VFD is received as follows:

<u>03</u>	<u>06</u>	<u>20 00</u>	<u>00 01</u>	<u>42 28</u>
VFD address	Write command	Parameter address	Forward running	CRC check

10.5 Common communication fault

Common communication faults: no response of the communication or the VFD returns abnormal fault.

The possible reason for no response to the communication:

- ✧ Selecting wrong serial interface, for example, if the converter is COM1, selecting COM2 during the communication
- ✧ The baud rate, digital bit, end bit and check bit are not the same with that of the VFD.
- ✧ + and - of RS485 bus are connected in reverse.
- ✧ The 485 wire cap on the terminal board of the VFD is not plug in. the wire cap in behind the terminal arrangement.

Appendix A Expansion card

A.1 What this chapter contains

This chapter describes the expansion cards used in Goodrive35 series VFDs.

A.2 PROFIBUS expansion card

(1) PROFIBUS is an open international fieldbus standard that allows data exchange among various types of automation components. It is widely used in manufacturing automation, process automation and in other automation areas such as buildings, transportation, power, providing an effective solution for realizing comprehensive automation and site-equipment intellectualization.

(2) PROFIBUS is composed of three compatible components, PROFIBUS (Decentralized Periphery, distributed peripherals), PROFIBUS (Process Automation), PROFIBUS-FMS (Fieldbus Message Specification). It is periodically exchange data with the VFD when using master-slave way. PRNV PROFIBUS Adapter module only supports PROFIBUS protocol.

(3) The physical transmission medium of bus is twisted-pair (in line with RS-485 standard), two-wire cable or fiber optic cable. Baud rate is from 9.6Kbit/s to 12Mbit/s. The maximum bus cable length is between 100 m and 1200 m, specific length depending on the selected transmission rate (see Appendix B "Technical data"). Up to 31 nodes can be connected to the same PROFIBUS network when repeaters aren't used, but if use repeaters, up to 127 nodes can be connected to the same PROFIBUS network segment (including repeaters and master stations).

(4) In the process of PROFIBUS communication, tokens are assigned among main stations and master-slave transmission among master-slave stations. Supporting single-master or multi-master system, stations-programmable logic controller (PLC)-choose nodes to respond to the host instruction. Cycle master-from user data transmission and non-cyclic master-master station can also send commands to multiple nodes in the form of broadcast. In this case, the nodes do not need to send feedback signals to the host. In the PROFIBUS network, communication between nodes cannot be allowed.

(5) PROFIBUS protocol is described in detail in EN 50170 standard. To obtain more information about PROFIBUS, please refer to the above-mentioned EN 50170 standards.

A.2.1 Product naming rules

Fieldbus adapter naming rules, the product model:

EC - TX 1 03
 ① ② ③ ④

No.	Instruction	Meaning
①	Product type	EC: Expansion card

No.	Instruction	Meaning
②	Card type	TX: Communication card
③	Technical version	Odds such as 1,3,5,7 means the 1 st , 2 nd , 3 rd , 4 th technical version
④	Card difference	03: PROFIBUS + Ethernet communication card 04: Ethernet + CAN communication card

A.2.2 EC-TX103 communication card

EC-TX103 communication card is an optional device to VFD which makes VFD connected to PROFIBUS network. In PROFIBUS network, VFD is a subsidiary device. The following functions can be completed using EC-TX103 communication card:

- ✧ Send control commands to the VFD (start, stop, fault reset, etc.).
- ✧ Send speed or given torque signal to the VFD.
- ✧ Read state and actual values from the VFD.
- ✧ Modify VFD parameter.

Refer to the description of function codes in Group P15 for the commands supported by the VFD.

Below is the structure diagram of the connection between the VFD and PROFIBUS bus:

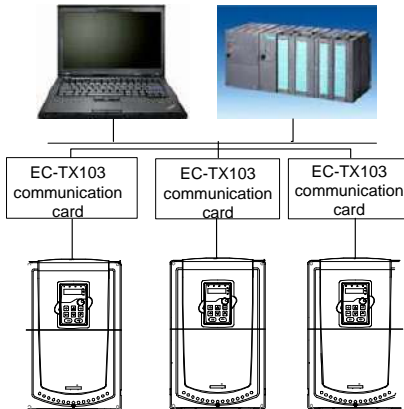

A.2.3 The appearance of EC-TX103 communication card

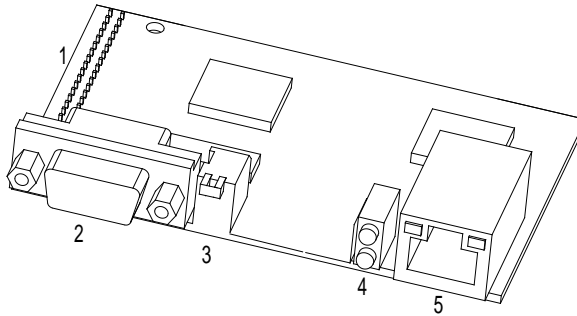

Figure A-1 Outline diagram of EC-TX103 communication card

1. Interface to the panel
2. Bus connector
3. Rotation node address selection switches
4. State display LEDs
5. Ethernet communication interface

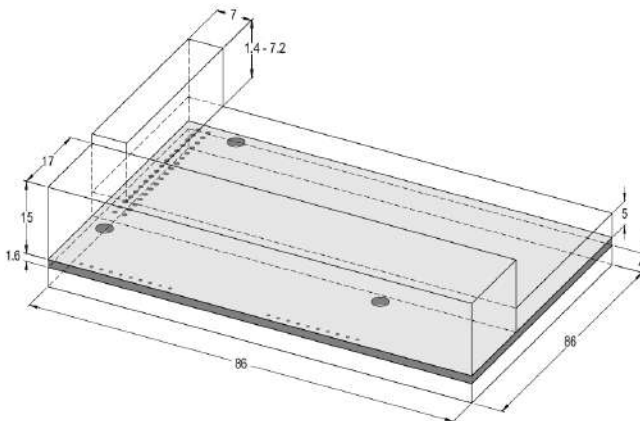

Figure A-2 External dimensions of EC-TX103 communication card (Unit: mm)

A.2.4 Compatible motor of EC-TX103 communication card

EC-TX103 communication card is compatible with the following products:

- ✧ Goodrive35 series VFDs and all VFDs supporting PROFIBUS expansion
- ✧ Host station supporting PROFIBUS-DP protocol

A.2.5 Delivery list

The package of EC-TX103 communication card contains:

- ✧ EC-TX103 communication card
- ✧ Three screws (M3x10)
- ✧ User's manual

Contact Shenzhen INVT Electric Co., Ltd. or suppliers if there is anything missing. Notice will not be given for the reason of product upgrades.

A.2.6 Installation of EC-TX103 communication card

A.2.6.1 Mechanical installation of EC-TX103 communication card

1. Installation ambient

- ✧ Ambient temperature: 0°C~+40°C
- ✧ Relative humidity: 5%~95%
- ✧ Other climate conditions: no dew, ice, rain, snow, hail air condition and the solar radiation is below 700W/m², air pressure 70~106kPa
- ✧ Content of salt spray and corrosive gases: Pollution degree 2
- ✧ Dust and solid particles content: Pollution degree 2
- ✧ Vibration and shock: 5.9m/s² (0.6g) on 9~200 Hz sinusoidal vibration

2. Installation steps:

- ✧ Fix the communication card on the location holes with screws.
- ✧ Insert the communication card into the defined location carefully and fix it on the copper column with screw.
- ✧ Set the bus terminal switch of the communication card to the needed location.

Notes:

- ✧ Disconnect the device from the power line before installation. Wait for at least three minutes to let the capacitors discharge. Cut off dangerous voltage from external control circuit to the unit output and input terminals.
- ✧ Some electric components are sensitive to static charge. Do not touch the circuit board. If you have to operate on it, please wear the grounding wrist belt.

A.2.6.2 Electrical installation of EC-TX103 communication card

1. Node selection

Node address is the only address of PROFIBUS bus. The address which is among 00~99 is shown with two figures and is selected by the spinning switch on the module. The left switch shows the first number and the right one show the second number.

Node address = 10 x the first digital value + the second digital value x 1

2. Bus terminals

There is a bus terminal in each heading and ending to avoid error during operation. The DIP switch on RPBA-01PCB is used to connect the bus terminals which can avoid the signal feedback from the bus cables. If the module is the first or last one in the internet, the bus terminal should be set as ON. Please disconnect EC-TX103 communication card terminals when the PROFIBUS D-sub connector with internal terminals is in use.

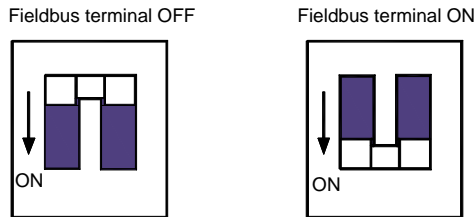

A.2.6.3 Bus net connection of EC-TX103 communication card

1. Bus communication interface

Transformation by double-shielded twisted pair copper cable is the most common way in PROFIBUS (conform to RS-485standard).

The basic characteristics of transformation technology:

- ✧ Net topology: Linear bus, there are bus resistor in two ends.
- ✧ Transforming speed: 9.6k bit/s–12M bit/s
- ✧ Medium: Double-shielded twisted pair cables, the shield can be removed according to the environment (EMC).
- ✧ Station number: There are 32 stations in each segment (without relays) as to 127 stations (with relays)
- ✧ Contact pin: 9 frames D pin, the connector contact pins are as below:

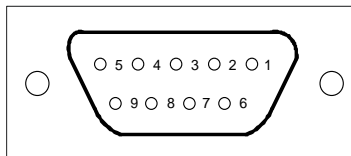

Contact pin of the connector		Instruction
1	-	Unused
2	-	Unused
3	B-Line	Positive data (twisted pair cables 1)

Contact pin of the connector		Instruction
4	RTS	Sending requirement
5	GND_BUS	Isolation ground
6	+5 V BUS	Isolated 5 V DC power supply
7	-	Unused
8	A-Line	Negative data (twisted pair cables 2)
9	-	Unused
Housing	SHLD	PROFIBUS shielded cable

+5 V and GND_BUS are used in the fieldbus terminals. Some devices, such as light transceiver (RS485) may get external power supply form these pins.

RTS is used in some devices to determine the sending direction. Only A-Line wires, B-Line wires and shield layer are used in the normal application.

It is recommended to apply the standard DB9 connector of SIEMENS. If the communication baud rate is above 187.5kbps, please follow the connection rules of SIEMENS seriously.



Available

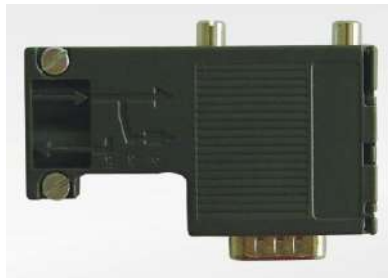

Not available (with interference to the keypad wiring)

2. Repeater

Up to 32 stations can be connected to each segment (master stations or stations), they have to be used when stations are more than 32. The repeaters in serial connection should not exceed 3.

Note: No station address is provided for repeaters, but they are calculated as stations.

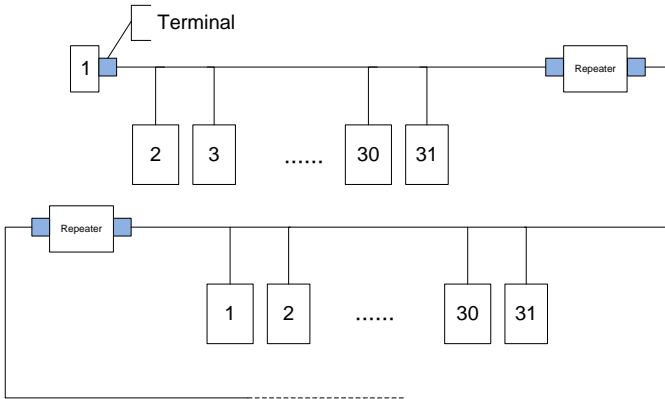

A.2.6.4 Transmission rate and maximum transmission distance

Maximum length of cable depends on the transmission rate. The Table below shows the relationship between transmission rate and distance.

Transmission rate (kbps)	A-wire (m)	B-wire (m)
9.6	1200	1200
19.2	1200	1200
93.75	1200	1200
187.5	1000	600
500	400	200
1500	200	-----
12000	100	-----

Transmission line parameters:

Transmission rate (kbps)	A-wire (m)	B-wire (m)
Impedance (Ω)	135–165	100–130
Capacitance per unit length (pF/m)	< 30	< 60
Loop Resistance (Ω /km)	110	-----
Core wire diameter (mm)	0.64	> 0.53
Line-core cross-section (mm^2)	> 0.34	> 0.22

Besides shielding twisted-pair copper wires, PROFIBUS can also use optical fiber for transmission in an electromagnetic interference environment to increase the high-speed transmission distance there are two kinds of fiber optical conductors, one is low-cost plastic fiber conductor, used distance is less than 50 meters, the other is glass fiber conductor, and used distance is less than 1 km.

A.2.6.5 PROFIBUS bus connection diagram

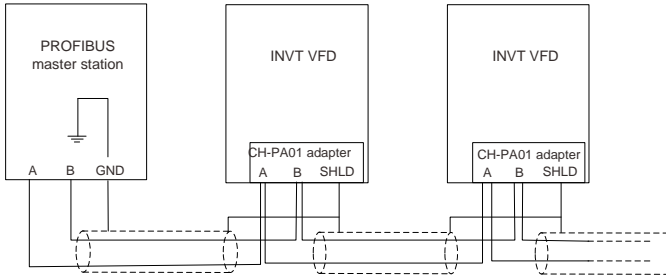

Above is "terminal" wiring diagram. Cable is a standard PROFIBUS cable consisting of a twisted pair and shielding layer. The shielded layer of PROFIBUS cable on all nodes is directly grounded. Users can choose the best grounding method according to the situation.

Note:

- ✧ Make sure that signal lines do not twist when connecting all stations. Shielded cable should be used when system runs under high electromagnetic interface environment, which can improve electromagnetic compatibility (EMC).
- ✧ If using shielded braided wire and shielding foil, both ends should be connected to ground. Using shielding area should be large enough to maintain a good conductivity. And data lines must be separated from high-voltage.
- ✧ Stub line segment should not be used when transmission rate more than 500K bit/s, The plug is available on the market which connects directly to data input and output cable. Bus plug connection can be on or off at any time without interruption of data communications of other station.

A.2.7 System configuration

1. System configuration

Master station and VFD should be configured so that the master station can communicate with the communication card after correctly installing EC-TX103 communication card.

Each PROFIBUS subsidiary station on the PROFIBUS bus need to have "device description document" named GSD file which used to describe the characteristics of PROFIBUS-DP devices. The software we provided for the user includes VFD related GSD files (device data files) information, users can obtain type definition file (GSD) of master machines from local INVT agent.

Configuration parameters of EC-TX103 communication card:

Parameter number	Parameter name	Optional setting	Factory setting
0	Module type	Read only	PROFIBUS-DP
1	Node address	0-99	2

Parameter number	Parameter name	Optional setting	Factory setting	
2	Baud rate setting	kbit/s	0: 9.6	6
			1: 19.2	
			2: 45.45	
			3: 93.75	
			4: 187.5	
		Mbit/s	5: 500	
			6: 1.5	
			7: 3	
			8: 6	
			9: 9	
10: 12				
3	PZD3	0-65535	0	
4	PZD4	The same as the above	0	
...	The same as the above	0	
10	PZD12	The same as the above	0	

2. Module type

This parameter shows communication module type detected by VFD; users can not adjust this parameter. If this parameter is not defined, communication between the communication card and VFD cannot be established.

3. Node address

In PROFIBUS network, each device corresponds to a unique node address, you can use the node address selection switch to define node address (switch isn't at 0) and the parameter is only used to display the node address. If node address selection switch is 0, this parameter can define node address.

In PROFIBUS network, each device corresponds to a unique node address, you can use the node address selection switch to define node address, but you cannot adjust the parameter by yourself and the parameter is only used to display the node address.

4. GSD file

In PROFIBUS network, each PROFIBUS subsidiary station needs GSD file "device description document" which used to describe the characteristics of PROFIBUS-DP devices. GSD file contains all defined parameters, including baud rate, information length, amount of input/output data, meaning of diagnostic data.

A CD-ROM will be offered in which contains GSD file of the EC-TX103 communication card (expansion name is .gsd) for fieldbus adapter. Users can copy GSD file to relevant subdirectory of configuration tools, please refer to relevant system configuration software instructions to know specific operations and PROFIBUS system configuration.

A.2.8 PROFIBUS-DP communication

1. PROFIBUS-DP

PROFIBUS-DP is a distributed I/O system, which enables master machine to use a large number of peripheral modules and field devices. Data transmission shows cycle: master machine read input information from subsidiary machine then give feedback signal. EC-TX103 communication card supports PROFIBUS-DP protocol.

2. Service access point

PROFIBUS-DP has access to PROFIBUS data link layer (Layer 2) services through service access point SAP. Every independent SAP has clearly defined function. Please refer to relevant PROFIBUS user manual to know more about service access point information. PROFIDRIVE - Variable speed drive adopts PROFIBUS model or EN50170 standards (PROFIBUS protocol).

3. PROFIBUS -DP information frame data structure

PROFIBUS-DP bus mode allows rapid data exchange between master station and VFD. Adopting master-slave mode dealing with VFD access, VFD is always subsidiary station, and each has definite address. PROFIBUS periodic transmission messages use 16 words (16 bit) transmission, the structure shown in the following figure.

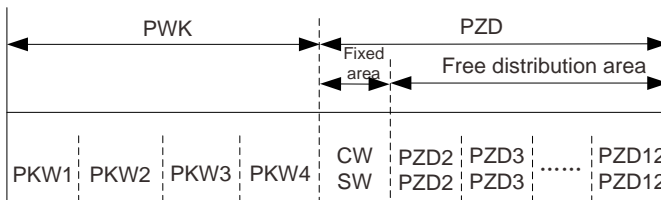

Parameters area:

PKW1-Parameter identification

PKW2-array index number

PKW3-parameter value 1

PKW4-parameter value 2

Process data:

CW-Control word (from master to slave, see "Control word (CW) of Goodrive35 series")

SW-state word (from slave to master, see "State word (SW) of Goodrive35 series")

PZD-process data (decided by users)

(From master to slave output 【given value】 , from slave to master input 【actual value】)

PZD area (process data area)

PZD area of communication message is designed for control and monitor VFD. PZD from master and slave stations is addressed in high priority; the priority of dealing with PZD is superior to that of PKW, and always sends current valid date from interface.

Control word (CW) and state word (SW)

Control word (CW) is a basic method of fieldbus system controlling VFD. It is sent by the fieldbus master station to VFD and the EC-TX103 communication cards act as gateway. VFD responds according to the control word and gives feedbacks to master machine through state word (SW).

Given value: VFD can receive control information by several ways, these channels include: analog and digital input terminals, VFD control board and communication module (such as RS485, EC-TX103 communication cards). In order to use PROFIBUS control VFD, the communication module must be set to be VFD controller.

Actual value: Actual value is a 16-bit word, which contains converter operation information. Monitoring capabilities are defined by VFD parameter. The integer scaling of actual value is sent to master machine depending on selected function, please refer to VFD manual.

Note: VFD always check the control word (CW) and bytes of given value.

Mission message (from the master station to the VFD)

Control word (CW): The first word of PZD is control word (CW) of VFD; due to different control word (CW) of PWM rectifier regenerative part and inverter part illustration is depart in next two tables.

Control word (CW) of Goodrive35 series

Bit	Name	Value	State/Description
0-7	COMMAND BYTE	1	Forward running
		2	Reverse running
		3	Forward jogging
		4	Reverse jogging
		5	Decelerate to stop
		6	Coast to stop (Emergency stop)
		7	Fault reset
		8	Jogging stop
8	WRITE ENABLE	1	Write enable (mainly is PKW1-PKW4)
9-10	MOTOR GROUP SELECTION	00	MOTOR GROUP 1 SELECTION
		01	MOTOR GROUP 2 SELECTION
		02	MOTOR GROUP 3 SELECTION
		03	MOTOR GROUP 4 SELECTION

Bit	Name	Value	State/Description
11	TORQUE CONTROL SELECTION	1	Torque control enable
		0	Torque control disable
12	ELECTRIC CONSUMPTION CLEAR	1	Electric consumption clear enable
		0	Electric consumption clear disable
13	PRE-EXCIATION	1	Pre-excitation enable
		0	Pre-excitation disable
14	DC BRAKING	1	DC braking enable
		0	DC braking disable
15	HEARTBEAT REF	1	Heartbeat enable
		0	Heartbeat disable

Reference value (REF): From 2nd word to 12th of PZD task message is the main set value REF, main frequency set value is offered by main setting signal source. As PWM rectifier feedback part doesn't have main frequency setting part, corresponding settings belong to reserved part, the following table shows inverter part settings for Goodrive35.

Bit	Name	Function selection
PZD2 receiving	0: Invalid	0
PZD3 receiving	1: Set frequency (0–Fmax (unit: 0.01 Hz))	0
PZD4 receiving	2: Given PID, range (0–1000, 1000 corresponds to 100.0%)	0
PZD5 receiving	3: PID feedback, range (0–1000, 1000 corresponds to 100.0%)	0
PZD6 receiving	4: Torque set value (-3000–3000,1000 corresponds to 100.0% the rated current of the motor)	0
PZD7 receiving	5: Set value of the forward rotation upper-limit frequency (0–Fmax unit: 0.01 Hz)	0
PZD8 receiving	6: Set value of the reversed rotation upper-limit frequency (0–Fmax (unit: 0.01 Hz))	0
PZD9 receiving	7: Electromotion torque upper limit (0–3000,1000 corresponds to 100.0%of the rated current of the motor)	0
PZD10 receiving	8: Braking torque upper limit (0–2000,1000 corresponds to 100.0% of the rated current of the motor)	
PZD11 receiving	9: Virtual input terminals command Range: 0x000–0x1FF	
	10: Virtual output terminals command Range: 0x00–0x0F	
PZD12 receiving		

Bit	Name	Function selection
	11: Voltage setting value (special for V/F separation) (0–1000,1000 corresponds to 100.0% the rated voltage of the motor) 12: AO output set value 1 (-1000→+1000, 1000 corresponds to 100.0%) 13: AO output set value 2 (-1000→+1000, 1000 corresponds to 100.0%) 14: MSB of position reference (signed digit) 15: LSB of position reference (unsigned digit) 16: MSB of position feedback (signed digit) 17: LSB of position feedback (unsigned digit) 18: Position feedback setting flag (Position feedback can be set only after you set this flag to 1 first and then set it to 0.)	

Response message (from the VFD to the master station)

State word (SW): The first word of PZD response message is state word (SW) of VFD, the definition of state word is as follows:

State word (SW) of Goodrive35 series

Bit	Name	Value	State/Description
0–7	RUN STATE BYTE	1	Forward running
		2	Reverse running
		3	The VFD stops
		4	The VFD is in fault
		5	The VFD is in POFF state
		6	Pre-exciting state
8	DC VOLTAGE ESTABLISH	1	Running ready
		0	The running preparation is not ready
9–10	MOTOR GROUP FEEDBACK	0	Motor 1 feedback
		1	Motor 2 feedback
		2	Motor 3 feedback
		3	Motor 4 no feedback
11	MOTOR TYPE FEEDBACK	1	Synchronous motor
		0	Asynchronous motor
12	OVERLOAD ALARM	1	Overload pre-alarm
		0	Non-overload pre-alarm
13	RUN/STOP MODE	0	Keypad control
		1	Terminal control

Bit	Name	Value	State/Description
14		2	Communication control
		3	Reserved
15	HEARTBEAT FEEDBACK	1	Heartbeat feedback
		0	No heartbeat feedback

Actual value (ACT): From 2nd word to 12th of PZD task message is main set value ACT, main frequency set value is offered by main setting signal source.

Actual state value of Goodrive35 series

Bit	Name	Function selection
PZD2 sending	0: Invalid	0
PZD3 sending	1: Running frequency (*100, Hz)	0
PZD4 sending	2: Set frequency (*100, Hz)	0
	3: Bus voltage (*10, V)	
PZD5 sending	4: Output voltage (*1, V)	0
	5: Output current (*10, A)	
PZD6 sending	6: Output torque actual value (*10, %)	0
	7: Output power actual value (*10, %)	
PZD7 sending	8: Running rotating speed (*1, RPM)	0
	9: Running linear speed (*1, m/s)	
PZD8 sending	10: Ramp reference frequency	0
	11: Fault code	
PZD9 sending	12: AI1 value (*100, V)	0
	13: AI2 value (*100, V)	
PZD10 sending	14: AI3 value (*100, V)	0
	15: PULSE frequency value (*100, kHz)	
PZD11 sending	16: Terminals input state	0
	17: Terminals output state	
PZD12 sending	18: PID given (*100, %)	0
	19: PID feedback (*100, %)	
	20: Motor rated torque	
	21: MSB of position reference (signed digit)	
	22: LSB of position reference (unsigned digit)	
	23: MSB of position feedback (signed digit)	
	24: LSB of position feedback (unsigned digit)	
	25: State words	

PKW area (parameter identification marks PKW1-value area). PKW area describes treatment of parameter identification interface, PKW interface is a mechanism which determine parameters transmission between two communication partners, such as reading and writing parameter values.

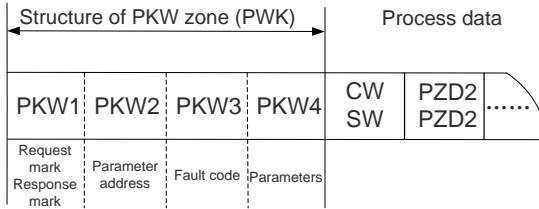

Parameter identification zone

In the process of periodic PROFIBUS-DP communication, PKW area is composed of four words (16 bit), each word is defined as follows:

The first word PKW1 (16 bit)		
Bit 15–00	Task or response identification marks	0–7
The second word PKW2 (16 bit)		
Bit 15–00	Basic parameters address	0–247
The third word PKW3 (16 bit)		
Bit 15–00	Parameter value (high word) or return error code value	00
The fourth word PKW4 (16 bit)		
Bit 15–00	Parameter value (low word)	0–65535

Note: If the master requests one parameter value, the value of PKW3 and PKW4 will not be valid.

Task requests and responses: When passing data to slave machine, master machine use request label while slave machine use response label to positive or negative confirmation. The following table lists the request/response functional.

The definition of task logo PKW1 is as follows:

Request label (From master to slave)		Response label	
Request	Function	Positive confirmation	Negative confirmation
0	No task	0	—
1	Request parameter value	1,2	3
2	Modification parameter value (one word) [only change RAM]	1	3 or 4
3	Modification parameter value (double word) [only change RAM]	2	3 or 4

Request label (From master to slave)		Response label	
4	Modification parameter value (one word) [RAM and EEPROM are modified]	1	3 or 4
5	Modification parameter value (double word) [RAM and EEPROM are modified]	2	3 or 4

Request label "2"-modification parameter value (one word) [only change RAM]; "3"-modification parameter value (double word) [only change RAM]; "5"-modification parameter value (double word) [RAM and EPROM are modified] not support currently.

Reponses logo PKW1 defines as below:

Response label (From slave to master)	
Confirmation	Function
0	No response
1	Transmission parameter value (one word)
2	Transmission parameter value (two words)
3	Task cannot be executed and returns the following error number: 0: Illegal parameter number 1: Parameter values cannot be changed (read-only parameter) 2: Out of set value range 3: The sub-index number is not correct 4: Setting is not allowed (only reset) 5: Data type is invalid 6: The task could not be implemented due to operational state 7: Request isn't supported. 8: Request can't be completed due to communication error 9: Fault occurs when write operation to stationary store 10: Request fails due to timeout 11: Parameter cannot be assigned to PZD 12: Control word bit can't be allocated 13: Other errors
4	No parameter change rights

PKW examples:

Example 1: Read parameter value. Read keypad set frequency value (the address of keypad set frequency is 10) which can be achieved by setting PKW1 as 1, PKW2 as 10, return value is in PKW4.

Request (From the master to the VFD):

	PKW1	PKW2	PKW3	PKW4	CW	PZD2	PZD3	...	PZD12
Request	00 01	00 10	00 00	00 00	xx xx	xx xx	xx xx	...	xx xx

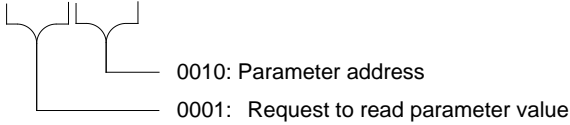

Response (From the VFD to the master)

	PKW1	PKW2	PKW3	PKW4	CW	PZD2	PZD3	...	PZD12
Response	00 01	00 10	00 00	50 00	xx xx	xx xx	xx xx	...	xx xx

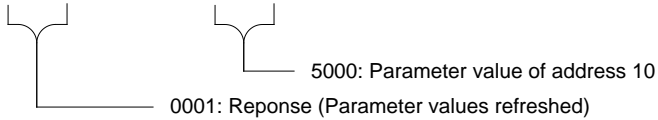

Example 2: Modify the parameter values (RAM and EEPROM are modified). Modify keypad settings frequency value (the address of keypad set frequency is 10) which can be achieved by setting PKW1 as 4; PKW2 as 10, modification value (50.00) is in PKW4.

Request (From the master to the VFD):

	PKW1	PKW2	PKW3	PKW4	CW	PZD2	PZD3	...	PZD12
Request	00 04	00 10	00 00	50 00	xx xx	xx xx	xx xx	...	xx xx

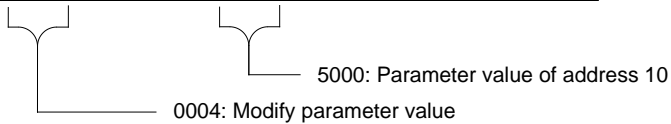

Response (From the VFD to the master)

	PKW1	PKW2	PKW3	PKW4	CW	PZD2	PZD3	...	PZD12
Response	00 01	00 10	00 00	50 00	xx xx	xx xx	xx xx	...	xx xx

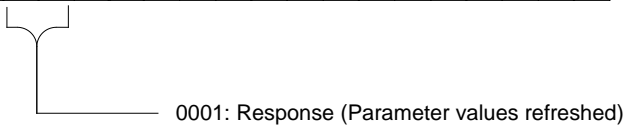

Examples for PZD: Transmission of PZD area is achieved through VFD function code; please refer to Examples for PZD: Transmission of PZD area is achieved through VFD function code; please refer to relevant INVT VFD user manual to know relevant function code.

Example 1: Read process data of the VFD.

VFD parameter selects "8: Run frequency" as PZD3 to transmit which can be achieved by setting P15.14 as 8. This operation is mandatory until the parameter is instead of others.

Request (From the master to the VFD):

	PKW1	PKW2	PKW3	PKW4	CW	PZD2	PZD3	...	PZD12
Response	xx xx	xx xx	xx xx	xx xx	xx xx	xx xx	00 0A	...	xx xx

Example 2: Write process data into the VFD

VFD parameter selects "2": Traction given" from PZD3 which can be achieved by setting P15.03 as 2. In each request frame, parameters will use PZD3 to update until re-select a parameter.

Request (From the master to the VFD):

	PKW1	PKW2	PKW3	PKW4	CW	PZD2	PZD3	...	PZD12
Response	00 04	xx xx	xx xx	xx xx	xx xx	xx xx	00 00	...	xx xx

In each request frame contents of PZD3 are given by traction until re-select a parameter.

A.2.9 Fault information

EC-TX103 communication card is equipped with 2 fault display LEDs as shown is figure below. The roles of these LEDs are as follows:

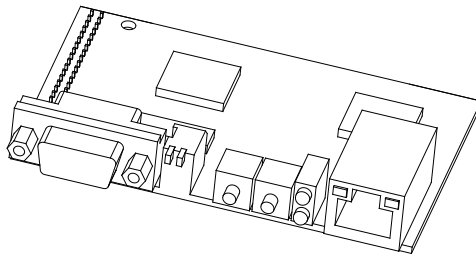

Figure A-3 Fault display LEDs

LED No.	Name	Color	Function
1	Online	Green	ON-module online and data can be exchanged. OFF-module is not in "online" state.
2	Offline/Fault	Red	ON-module offline and data can't be exchanged. OFF-module is not in "offline" state. 1. Flicker frequency 1 Hz-configuration error: The length of user parameter data sets is different from that of network configuration process during module initialization process. 2. Flicker frequency 2 Hz-user parameter data error: The length or content of user parameter data sets is different from that of

LED No.	Name	Color	Function
			network configuration process during module initialization process. 3. Flicker frequency 4 Hz-PROFIBUS communication ASIC initialization error. 4. OFF-Diagnostic closed.

A.3 CANopen optional cards

Refer to the operation manual of EC-TX105 CANopen communication cards.

Appendix B Technical data

B.1 What this chapter contains

This chapter contains the technical specifications of the VFD, as well as provisions for fulfilling the requirements for CE and other marks.

B.2 Ratings

B.2.1 Capacity

Choose a VFD based on the rated current and power of the motor. To endure the rated power of the motor, the rated output current of the VFD must be larger or equal to the rated current of the motor. The rated power of the VFD must be higher or equal to that of the motor.

Note:

- ✧ The maximum allowable shaft power of the motor is limited to 1.5 times the rated power of the motor. If the limit is exceeded, the VFD automatically restricts the torque and current of the motor. This function effectively protects the input shaft against overload.
- ✧ The rated capacity is the capacity at the ambient temperature of 40°C.
- ✧ You need to check and ensure that the power flowing through the common DC connection in the common DC system does not exceed the rated power of the motor.

B.2.2 Derating

If the ambient temperature on the site where the VFD is installed exceeds 40°C, the altitude exceeds 1000 m, or the switching frequency is changed from 4 kHz to 8, 12, or 15 kHz, the VFD needs to be derated.

B.2.2.1 Temperature derating

When the temperature ranges from +40°C to +50°C, the rated output current is derated by 1% for each increased 1°C. For the actual derating, see the following figure.

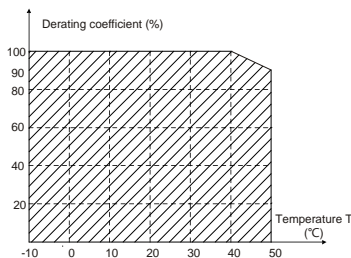

B.2.2.2 Altitude derating

When the altitude of the site where the VFD is installed is lower than 1000m, the VFD can run at the rated power. When the altitude exceeds 1000m, derate by 1% for every increase of 100m. When the altitude exceeds 3000m, consult the local INVT dealer or office for details.

B.2.2.3 Carrier frequency derating

The power of Goodrive350 series VFDs varies according to carrier frequencies. The rated power of a VFD is defined based on the carrier frequency set in factory. If the carrier frequency exceeds the factory setting, the power of the VFD is derated by 10% for each increased 1 kHz.

B.3 Grid specifications

Grid voltage	AC 3PH 380 V (-15%)–440 V (+10%)
	AC 3PH 380 V (-10%)–550 V (+10%)
	AC 3PH 520 V (-15%)–690 V (+10%)
Short-circuit capacity	According to the definition in IEC 61439-1, the maximum allowable short-circuit current at the incoming end is 100 kA. Therefore, the VFD is applicable to scenarios where the transmitted current in the circuit is no larger than 100 kA when the VFD runs at the maximum rated voltage.
Frequency	50/60 Hz±5%, with a maximum change rate of 20%/s

B.4 Motor connection data

Motor type	Asynchronous induction motor or synchronous permanent magnet motor
Voltage	0 to U ₁ , 3-phase symmetrical, U _{max} at the field weakening point
Short-circuit protection	The motor output is short-circuit proof by IEC 61800-5-1
Frequency	0–400 Hz
Frequency resolution	0.01 Hz
Current	Refer to section 3.6 "Rated values"
Power limit	Refer to section 3.6 "Rated values"
Field weakening point	10–400 Hz
Carrier frequency	4, 8, 12 or 15 kHz

B.4.1 EMC compatibility and motor cable length

The following table describes the maximum motor cable lengths that meet the requirements of the EU EMC directive (2004/108/EC).

All models (with external EMC filters)	Maximum motor cable length (m)
Environment category II (C3)	30

You can learn the maximum length of the motor cable through the running parameters of the VFD. To understand the accurate maximum cable length for using an external EMC filter, contact the local INVT office.

For description about the environments categories I (C2) and II (C3), see section B.6 "EMC regulations".

B.5 Applicable standards

The VFD complies with the following standards:

EN ISO 13849-1	Safety of machinery—Safety-related parts of control systems—Part 1: General principles for design
IEC/EN 60204-1	Safety of machinery—Electrical equipment of machines. Part 1: General requirements
IEC/EN 62061	Safety of machinery—Safety-related functional safety of electrical, electronic, and programmable electronic control systems
IEC/EN 61800-3	Adjustable speed electrical power drive systems—Part 3: EMC requirements and specific test methods
IEC/EN 61800-5-1	Adjustable speed electrical power drive systems—Part 5-1: Safety requirements—Electrical, thermal and energy
IEC/EN 61800-5-2	Adjustable speed electrical power drive systems—Part 5-2: Safety requirements—Function
GB/T 30844.1-2014	General-purpose variable-frequency adjustable-speed equipment of 1 kV and lower—Part 1: Technical conditions
GB/T 30844.2-2014	General-purpose variable-frequency adjustable-speed equipment of 1 kV and lower—Part 2: Test methods
GB/T 30844.3-2014	General-purpose variable-frequency adjustable-speed equipment of 1 kV and lower—Part 3: Safety regulations

B.5.1 CE marking

The CE marking on the nameplate of a VFD indicates that the VFD is CE-compliant, meeting the regulations of the European low-voltage directive (2014/35/EU) and EMC directive (2014/30/EU).

B.5.2 EMC compliance declaration

European union (EU) stipulates that the electric and electrical devices sold in Europe cannot generate electromagnetic disturbance that exceeds the limits stipulated in related standards, and can work properly in environments with certain electromagnetic interference. The EMC product standard (EN 61800-3) describes the EMC standards and specific test methods for adjustable speed electrical power drive systems. Products must strictly follow these EMC regulations.

B.6 EMC regulations

The EMC product standard (EN 61800-3) describes the EMC requirements on VFDs.

Application environment categories

Category I: Civilian environments, including application scenarios where VFDs are directly connected to the civil power supply low-voltage grids without intermediate transformers

Category II: All environments except those in Category I.

VFD categories

C1: Rated voltage lower than 1000 V, applied to environments of Category I.

C2: Rated voltage lower than 1000 V, non-plug, socket, or mobile devices; power drive systems that must be installed and operated by specialized personnel when applied to environments of Category I

Note: The EMC standard IEC/EN 61800-3 no longer restricts the power distribution of VFDs, but it specifies their use, installation, and commissioning. Specialized personnel or organizations must have the necessary skills (including the EMC-related knowledge) for installing and/or performing commissioning on the electrical drive systems.

C3: Rated voltage lower than 1000 V, applied to environments of Category II. They cannot be applied to environments of Category I.

C4: Rated voltage higher than 1000 V, or rated current higher or equal to 400 A, applied to complex systems in environments of Category II.

B.6.1 Category C2

The induction disturbance limit meets the following stipulations:

1. Select an optional EMC filter according to Appendix D "Optional peripheral accessories" and install it following the description in the EMC filter manual.
2. Select the motor and control cables according to the description in the manual.
3. Install the VFD according to the description in the manual.
4. For the maximum length of the motor cable, see section B.4.1 "EMC compatibility and motor cable length".



Currently in environments in China, the VFD may generate radio interference, you need to take measures to reduce the interference.

B.6.2 Category C3

The anti-interference performance of the VFD meets the requirements of environments Category II in the IEC/EN 61800-3 standard.

The induction disturbance limit meets the following stipulations:

1. Select an optional EMC filter according to Appendix D "Optional peripheral accessories" and install it following the description in the EMC filter manual.
2. Select the motor and control cables according to the description in the manual.
3. Install the VFD according to the description in the manual.
4. For the maximum length of the motor cable, see section B.4.1 "EMC compatibility and motor cable length".



VFDs of C3 category cannot be applied to civilian low-voltage common grids. When applied to such grids, the VFD may generate radio frequency electromagnetic interference.

Appendix C Dimension drawings

C.1 What this chapter contains

Dimension drawings of the Goodrive35 are shown below. The dimensions are given in millimeters and inches.

C.2 Keypad structure

C.2.1 Structure chart

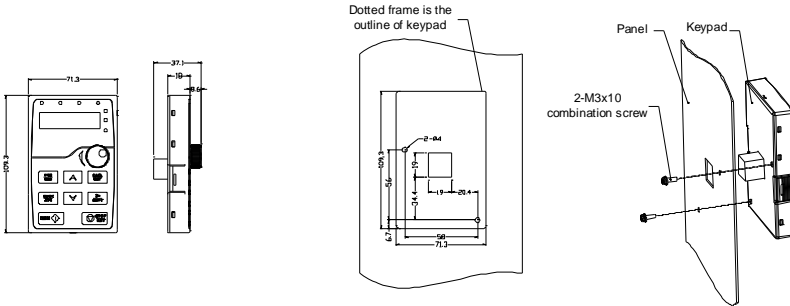

Hole dimension and diagram for keypad installation without bracket

C.2.2 Installation bracket

Note: The external keypad can be fix by M3 screws directly or the installation bracket. The installation bracket for VFDs of 380 V 1.5–30 kW is optional, the installation bracket for VFDs of 380 V 37–315 kW and 660 V 22–630 kW is optional or substitutive by the external standard one.

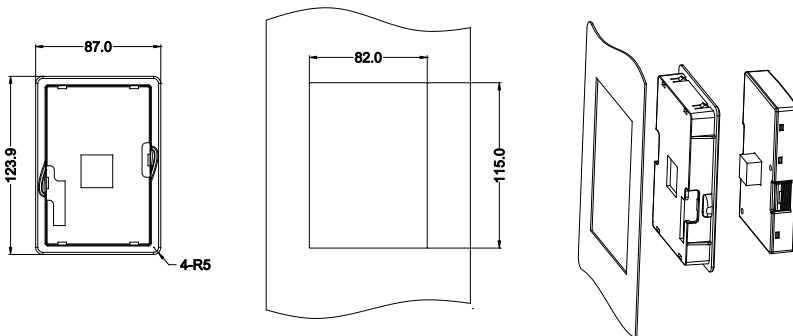

Keypad bracket

Customer installation dimension

Figure C-1 Installation bracket of the keypad (380 V 1.5–315 kW; 660 V 22–630 kW) (optional)

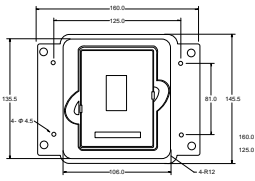

Keypad adapter bracket

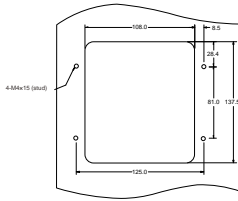

Customer installation dimension

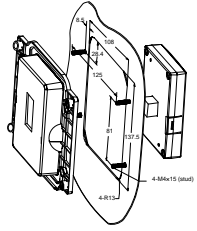
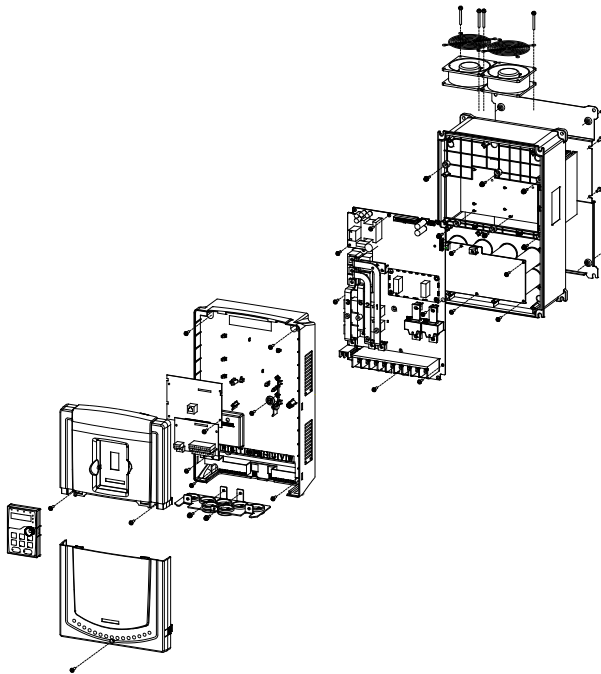

Figure C-2 Installation bracket of the keypad (380 V 37–315 kW; 660 V 22–630 kW) (standard)

C.3 VFD structure



C.4 Dimensions for VFDs of AC 3PH 380 V (-15%)–440 V (+10%)

C.4.1 Wall installation (unit: mm)

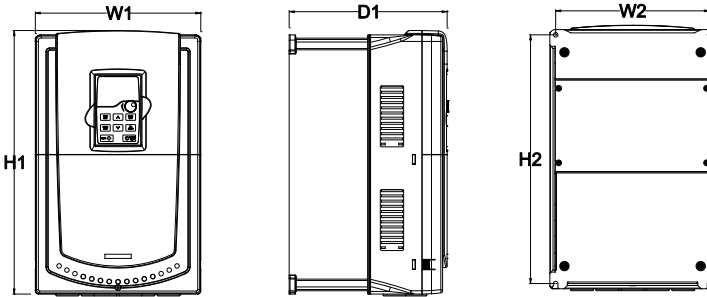

Figure C-3 Wall installation of 380 V 1.5-30 kW VFDs

Model	W1	W2	H1	H2	D1	Installation hole	Weight (kg)
1.5 kW–2.2 kW	126	115	193	175	174.5	∅5	2
4 kW–5.5 kW	146	131	263	243.5	181	∅6	3.5
7.5 kW–11 kW	170	151	331.5	303.5	216	∅6	6
15 kW–18.5 kW	230	210	342	311	216	∅6	7.8
22 kW–30 kW	255	237	407	384	245	∅7	9.5

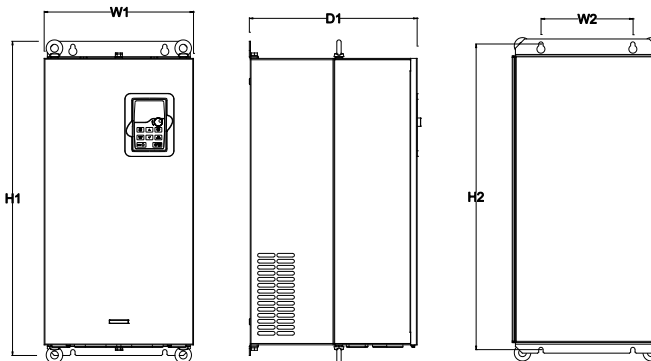

Figure C-4 Wall installation of 380 V 37-110 kW VFDs

Model	W1	W2	H1	H2	D1	Installation hole	Weight (kg)
37 kW–55 kW	270	130	555	540	325	∅7	30
75 kW–110 kW	325	200	680	661	365	∅9.5	47

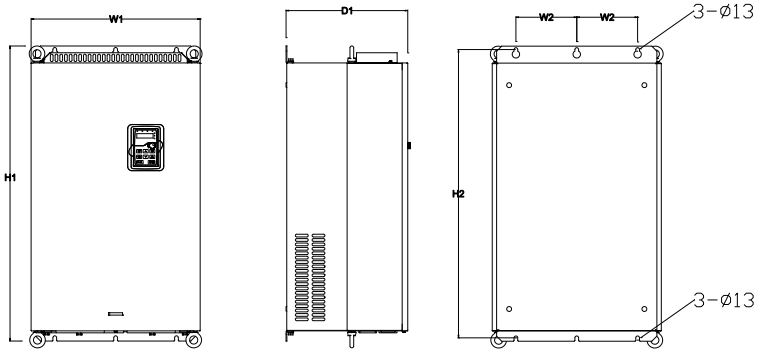

Figure C-5 Wall installation of 380 V 132-200 kW VFDs

Model	W1	W2	H1	H2	D1	Installation hole	Weight (kg)
132 kW–200 kW	500	180	870	850	360	∅11	85

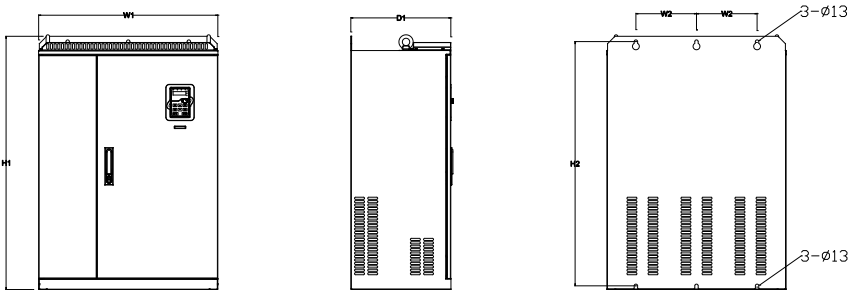

Figure C-6 Wall installation of 380 V 220-315 kW VFDs

Model	W1	W2	H1	H2	D1	Installation hole	Weight (kg)
220 kW–280 kW	680	230	960	926	380	∅13	135
315 kW	680	230	960	926	380	∅13	137

C.4.2 Flange installation (unit: mm)

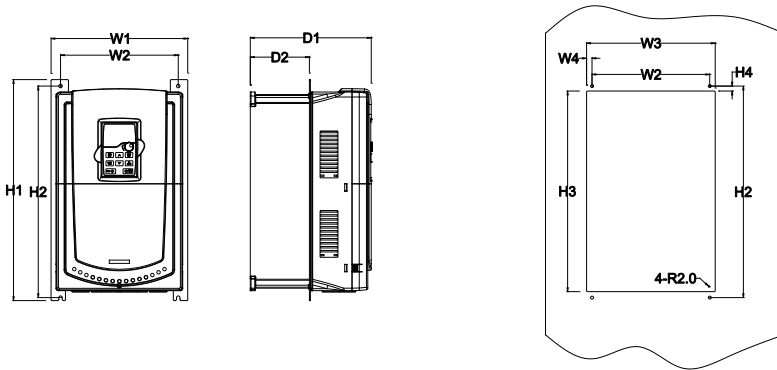

Figure C-7 Flange installation of 380 V 1.5-30 kW VFDs

Model	W1	W2	W3	W4	H1	H2	H3	H4	D1	D2	Installation hole	Weight (kg)
1.5 kW–2.2 kW	150	115	130	7.5	234	220	190	16.5	174.5	65.5	∅5	2
4 kW–5.5 kW	170	131	150	9.5	292	276	260	10	181	79.5	∅6	3.5
7.5 kW–11 kW	191	151	174	11.5	370	351	324	15	216.2	113	∅6	6
15 kW–18.5 kW	250	210	234	12	375	356	334	10	216	108	∅6	7.8
22 kW–30 kW	275	237	259	11	445	426	404	10	245	119	∅7	9.5

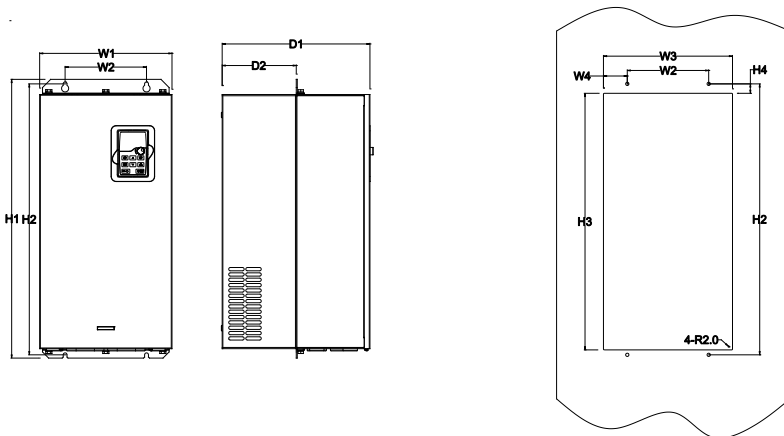

Figure C-8 Flange installation of 380 V 37-110 kW VFDs

Model	W1	W2	W3	W4	H1	H2	H3	H4	D1	D2	Installation hole	Weight (kg)
37 kW–55 kW	270	130	261	65.5	555	540	516	17	325	167	∅7	30
75 kW–110 kW	325	200	317	58.5	680	661	626	23	363	182	∅9.5	47

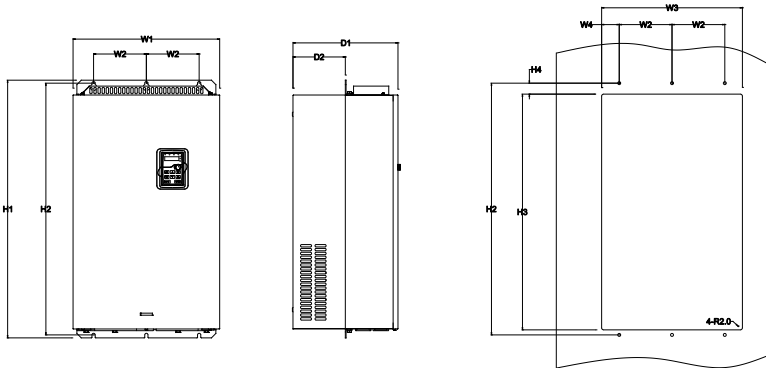

Figure C-9 Flange installation of 380 V 132-200 kW VFDs

Model	W1	W2	W3	W4	H1	H2	H3	H4	D1	D2	Installation hole	Weight (kg)
132 kW–200 kW	500	180	480	60	870	850	796	37	358	178.5	∅11	85

C.4.3 Floor installation (unit: mm)

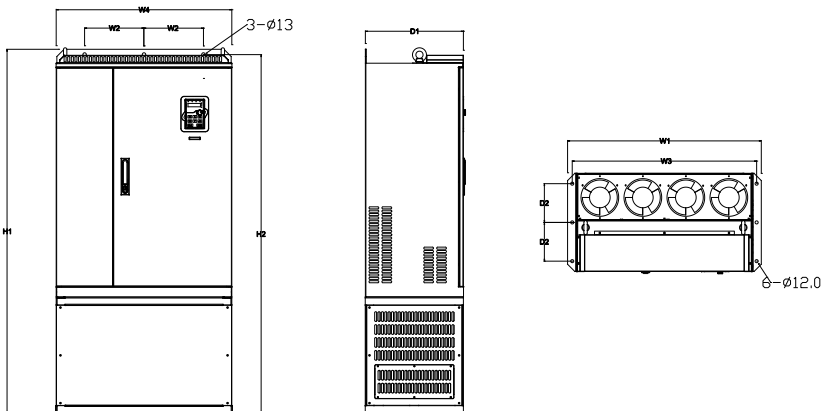

Figure C-10 Floor installation of 380 V 220-315 kW VFDs

Model	W1	W2	W3	W4	H1	H2	D1	D2	Installation hole	Weight (kg)
220 kW–280 kW	750	230	714	680	1410	1390	380	150	∅13/12	135
315 kW	750	230	714	680	1410	1390	380	150	∅13/12	137

C.5 Dimensions for VFDs of AC 3PH 520 V (-15%)–690 V (+10%)

C.5.1 Wall installation (unit: mm)

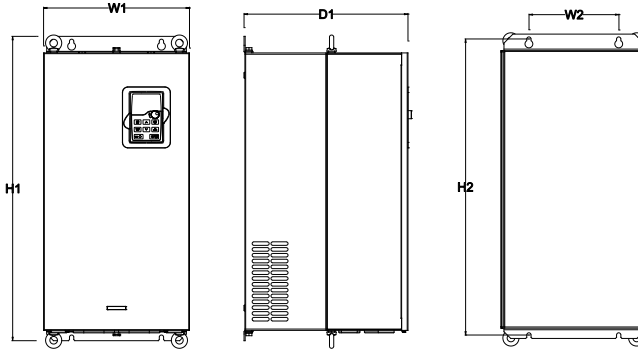

Figure C-11 Wall installation of 660 V 22-132 kW VFDs

Model	W1	W2	H1	H2	D1	Installation hole	Weight (kg)
22 kW–45 kW	270	130	555	540	325	∅7	30
55 kW–132 kW	325	200	680	661	365	∅9.5	47
132 kW	325	200	680	661	365	∅9.5	85

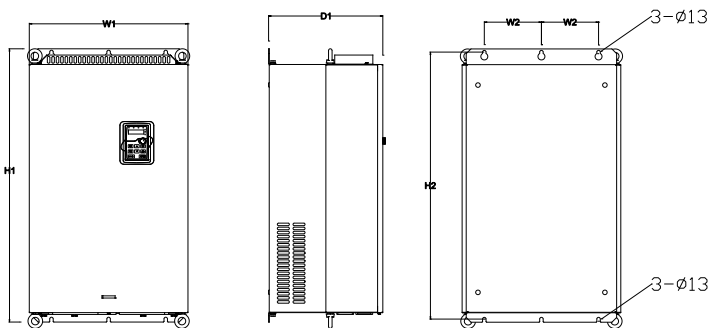

Figure C-12 Wall installation of 660 V 160-220 kW VFDs

Model	W1	W2	H1	H2	D1	Installation hole	Weight (kg)
160 kW–220 kW	500	180	870	850	360	∅11	85

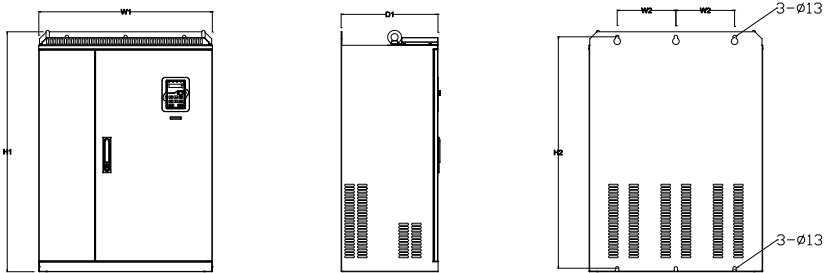

Figure C-13 Wall installation of 660 V 250-350 kW VFDs

Model	W1	W2	H1	H2	D1	Installation hole	Weight (kg)
250 kW–350 kW	680	230	960	926	380	ø13	135

C.5.2 Flange installation (unit: mm)

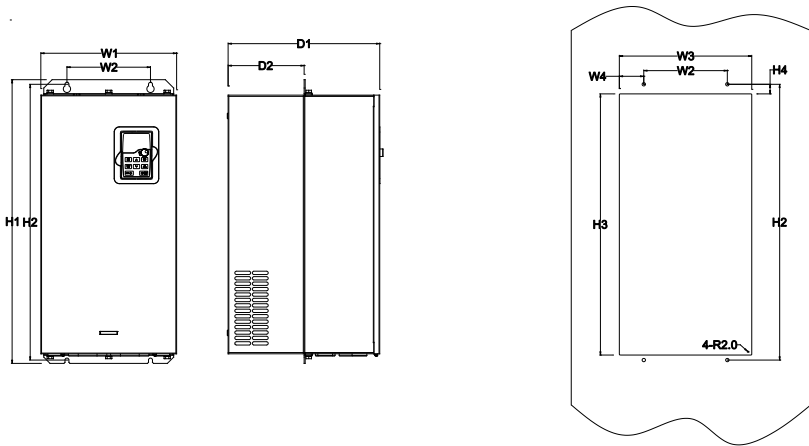

Figure C-14 Flange installation of 660 V 22-132 kW VFDs

Model	W1	W2	W3	W4	H1	H2	H3	H4	D1	D2	Installation hole	Weight (kg)
22 kW–45 kW	270	130	261	65.5	555	540	516	17	325	167	ø7	30
55 kW–110 kW	325	200	317	58.5	680	661	626	23	363	182	ø9.5	47
132 kW	325	200	317	58.5	680	661	626	23	363	182	ø9.5	85

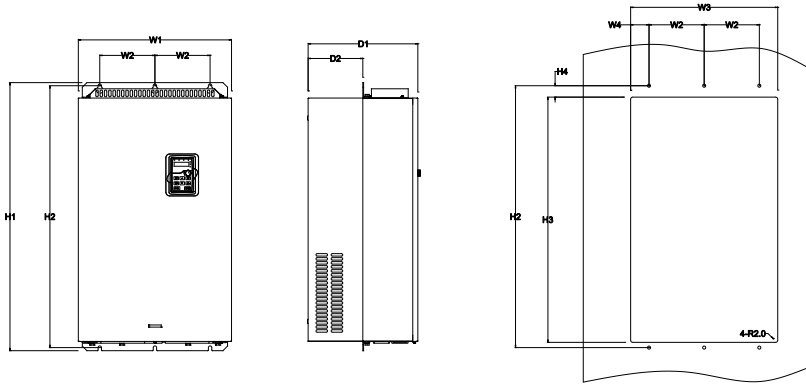

Figure C-15 Flange installation of 660 V 160-220 kW VFDs

Model	W1	W2	W3	W4	H1	H2	H3	H4	D1	D2	Installation hole	Weight (kg)
160 kW–220 kW	500	180	480	60	870	850	796	37	358	178.5	∅11	85

C.5.3 Floor installation (unit: mm)

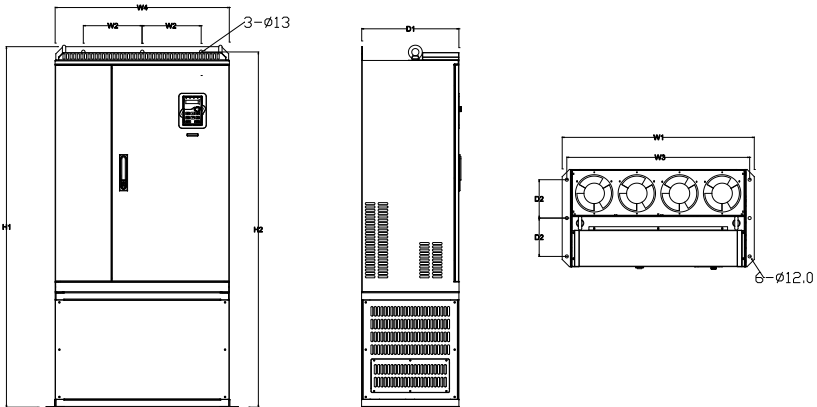

Figure C-16 Floor installation of 660 V 250-350 kW VFDs

Model	W1	W2	W3	W4	H1	H2	D1	D2	Installation hole	Weight (kg)
250 kW–350 kW	750	230	714	680	1410	1390	380	150	∅13/12	135

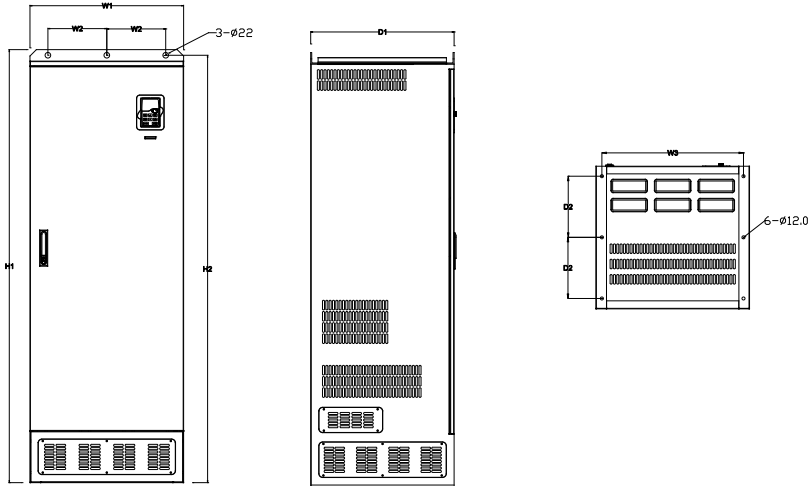

Figure C-17 Floor installation of 660 V 400-630 kW VFDs

Model	W1	W2	W3	W4	H1	H2	D1	D2	Installation hole	Weight (kg)
400 kW–630 kW	620	230	573	/	1700	1678	560	240	φ22/12	390

Appendix D Optional peripheral accessories

D.1 What this chapter contains

This chapter describes how to select the options and parts of Goodrive35 series.





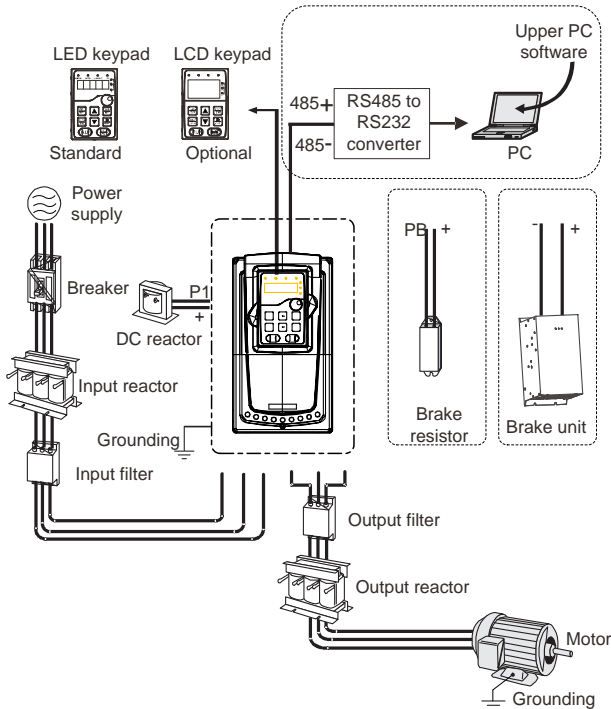

D.2 Peripheral wiring

Below is the peripheral wiring of Goodrive35 series VFDs.

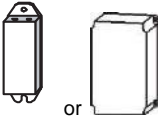

Note:

- ✧ Built-in braking unit is included for 380 V 30 kW and below models;
- ✧ P1 terminal is included for 380 V 37 kW and above models, which can be connected to external DC reactor directly;
- ✧ P1 terminal is included for 660 V and above models, which can be connected to external DC reactor directly;
- ✧ The braking units INVT's DBU series standard braking units. For details, see the DBU operation manual.

Pictures	Name	Descriptions
	Cables	Device to transfer the electronic signals
	Breaker	Prevent from electric shock and protect the power supply and the cables system from overcurrent when short circuits occur. (Please select the breaker with the function of reducing high order harmonic and the rated sensitive current to 1 VFD should be above 30mA).
	Input reactor	This device is used to improve the power factor of the input side of the VFD and control the higher harmonic current.
	DC reactor	The VFDs of 380 V (≥ 37 kW) and of 660 V have external DC reactors.
	Input filter	Control the electromagnetic interference generated from the VFD, please install close to the input terminal side of the VFD. Accessory that restricts the electromagnetic interference generated by the VFD and transmitted to the public grid through the power cable. Try to install the input filter near the input terminal side of the VFD.
	Braking unit or braking resistors	Accessories used to consume the regenerative energy of the motor to reduce the deceleration time. VFDs of 380 V, 30 kW or lower need only to be configured with braking resistors, those of 380V, 37 kW or higher and 660 V series also need to be configured with braking units,.
	Output filter	Control the interference from the output side of the VFD and please install close to the output terminals of the VFD.
	Output reactor	Prolong the effective transmitting distance of the VFD to control the sudden high voltage when switching on/off the IGBT of the VFD.

D.3 Power supply

Please refer to 3.6.1 "Rated value of AC 3PH 520 V (-15%)–690 V (+10%)".

	Check that the voltage degree of the VFD complies with that of the grid.
---	--

D.4 Cables

D.4.1 Power cables

Dimension the input power and motor cables according to local regulations.

1. The input power and the motor cables must be able to carry the corresponding load currents.
2. The cable must be rated for at least 70°C maximum permissible temperature of the conductor in continuous use.
3. The conductivity of the PE conductor must be equal to that of the phase conductor (same cross-sectional area).
4. For details about the EMC requirements, see Appendix B "Technical data".

To meet the EMC requirements stipulated in the CE standards, you must use symmetrical shielded cables as motor cables (as shown in the following figure).

Four-core cables can be used as input cables, but symmetrical shielded cables are recommended. Compared with four-core cables, symmetrical shielded cables can reduce electromagnetic radiation as well as the current and loss of the motor cables.

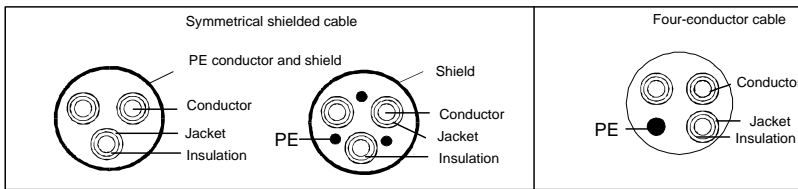

Note: If the conductivity of the shield layer of the motor cables cannot meet the requirements, separate PE conductors must be used.

To protect the conductors, the cross-sectional area of the shielded cables must be the same as that of the phase conductors if the cable and conductor are made of materials of the same type. This reduces grounding resistance, and thus improves impedance continuity.

To effectively restrict the emission and conduction of radio frequency (RF) interference, the conductivity of the shielded cable must at least be 1/10 of the conductivity of the phase conductor. This requirement can be well met by a copper or aluminum shield layer. The following figure shows the minimum requirement on motor cables of a VFD. The cable must consist of a layer of spiral-shaped copper strips. The denser the shield layer is, the more effectively the electromagnetic interference is restricted.

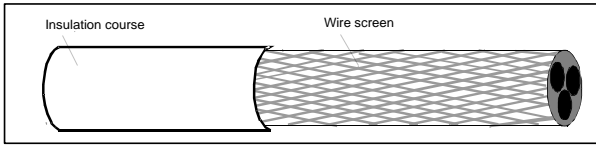

Figure D-1 Cross-section of the cable

D.4.2 Control cables

All analog control cables and cables used for frequency input must be shielded cables. Analog signal cables need to be double-shielded twisted-pair cables (as shown in figure a). Use one separate shielded twisted pair for each signal. Do not use the same ground wire for different analog signals.

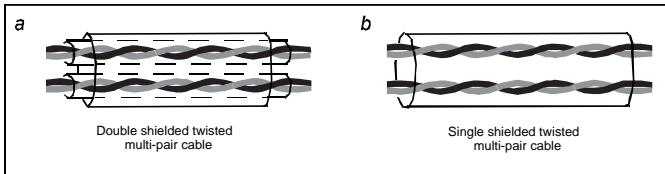

Figure D-2 Configuration of the power cable

For low-voltage digital signals, double-shielded cables are recommended, but shielded or unshielded twisted pairs (as shown in figure b) also can be used. For frequency signals, however, only shielded cables can be used.

Relay cables need to be those with metal braided shield layers.

Keypads need to be connected by using network cables. In complicated electromagnetic environments, shielded network cables are recommended.

Note: Analog signals and digital signals cannot use the same cables, and their cables must be arranged separately.

Do not perform any voltage endurance or insulation resistance tests, such as high-voltage insulation tests or using a megameter to measure the insulation resistance, on the VFD or its components. Insulation and voltage endurance tests have been performed between the main circuit and chassis of each VFD before delivery. In addition, voltage limiting circuits that can automatically cut off the test voltage are configured inside the VFDs.

Note: Check the insulation conditions of the input power cable of a VFD according to the local regulations before connecting it.

D.4.2.1 The VFDs of AC 3PH 380 V (-15%)–440 V (+10%)

Model	Recommended cable size (mm ²)		Size of connectable cable (mm ²)				Terminal screw	Tightening torque (Nm)
	RST UVW	PE	RST UVW	P1, (+)	PB (+), (-)	PE		
GD35-1R5G-4-C1/D1/H1	2.5	2.5	2.5–6	2.5–6	2.5–6	2.5–6	M4	1.2–1.5
GD35-2R2G-4-C1/D1/H1	2.5	2.5	2.5–6	2.5–6	2.5–6	2.5–6	M4	1.2–1.5
GD35-004G-4-C1/D1/H1/H2	2.5	2.5	2.5–6	2.5–6	2.5–6	2.5–6	M4	1.2–1.5
GD35-5R5G-4-C1/D1/H1/H2	2.5	2.5	2.5–6	4–6	4–6	2.5–6	M4	1.2–1.5
GD35-7R5G-4-C1/D1/H1/H2	4	4	4–16	4–16	4–16	4–16	M5	2–2.5
GD35-011G-4-C1/D1/H1/H2	6	6	6–16	6–16	6–16	6–16	M5	2–2.5
GD35-015G-4-C1/D1/H1/H2	10	10	10–25	10–25	10–25	6–25	M5	2–2.5
GD35-018G-4-C1/D1/H1/H2	16	16	16–25	16–25	16–25	10–25	M5	2–2.5
GD35-022G-4-C1/D1/H1/H2	16	16	16–25	16–25	16–25	10–25	M6	4–6
GD35-030G-4-C1/D1/H1/H2	25	16	16–25	16–25	16–25	16–25	M6	4–6
GD35-037G-4-C1/D1/H1	25	16	25–50	25–50	25–50	16–50	M8	9–11
GD35-045G-4-C1/D1/H1	35	16	25–50	25–50	25–50	16–50	M8	9–11
GD35-055G-4-C1/D1/H1	50	25	50–95	50–95	50–95	25–50	M8	9–11
GD35-075G-4-C1/D1/H1	70	35	70–95	70–95	70–95	35–50	M10	18–23
GD35-090G-4-C1/D1/H1	95	50	95–150	95–150	95–150	50–150	M10	18–23
GD35-110G-4-C1/D1/H1	120	70	95–300	95–300	95–300	70–240	M10	18–23
GD35-132G-4-C1/D1/H1	185	95	95–300	95–300	95–300	95–240	It is recommended to use wrench or sleeve because screw is used as terminal.	
GD35-160G-4-C1/D1/H1	240	120	95–300	95–300	95–300	120–240		
GD35-185G-4-C1/D1/H1	95*2P	95	95–150	70–150	70–150	35–95		
GD35-200G-4-C1/D1/H1	95*2P	120	95*2P–150*2P	95*2P–150*2P	95*2P–150*2P	120–240		
GD35-220G-4-C1/D1/H1	150*2P	150	95*2P–150*2P	95*2P–150*2P	95*2P–150*2P	150–240		
GD35-250G-4-C1/D1/H1	95*4P	95*2P	95*4P–150*4P	95*4P–150*4P	95*4P–150*4P	95*2P–150*2P		
GD35-280G-4-C1/D1/H1	95*4P	95*2P	95*4P–150*4P	95*4P–150*4P	95*4P–150*4P	95*2P–150*2P		
GD35-315G-4-C1/D1/H1	95*4P	95*4P	95*4P–150*4P	95*4P–150*4P	95*4P–150*4P	95*2P–150*2P		

Note:

- ✧ Cables of the sizes recommended for the main circuit can be used in scenarios where the ambient temperature is lower than 40°C, the wiring distance is shorter than 100 m, and the current is the rated current.

◇ The terminals P1, (+), and (-) are used to connect to DC reactors and braking accessories.

D.4.2.2 The VFDs of AC 3PH 520 V (-15%)–690 V (+10%)

Model	Recommended cable size (mm ²)		Size of connectable cable (mm ²)				Terminal screw	Tightening torque (Nm)
	RST UVW	PE	RST UVW	P1, (+)	PB (+), (-)	PE		
GD35-022G-6-C1/D1/H1	10	10	10–16	6–16	6–10	10–16	M8	9–11
GD35-030G-6-C1/D1/H1	10	10	10–16	6–16	6–10	10–16	M8	9–11
GD35-037G-6-C1/D1/H1	16	16	16–25	16–25	6–10	16–25	M8	9–11
GD35-045G-6-C1/D1/H1	16	16	16–25	16–35	16–25	16–25	M8	9–11
GD35-055G-6-C1/D1/H1	25	16	16–25	16–35	16–25	16–25	M10	18–23
GD35-075G-6-C1/D1/H1	35	16	35–50	25–50	25–50	16–50	M10	18–23
GD35-090G-6-C1/D1/H1	35	16	35–50	25–50	25–50	16–50	M10	18–23
GD35-110G-6-C1/D1/H1	50	25	50–95	50–95	25–95	25–95	M10	18–23
GD35-132G-6-C1/D1/H1	70	35	70–95	70–95	25–95	35–95	M10	18–23
GD35-160G-6-C1/D1/H1	95	50	95–150	95–150	25–150	50–150	It is recommended to use wrench or sleeve because screw is used as terminal.	
GD35-185G-6-C1/D1/H1	95	50	95–150	95–150	25–150	50–150		
GD35-200G-6-C1/D1/H1	120	70	120–300	120–300	35–300	70–240		
GD35-220G-6-C1/D1/H1	185	95	120–300	120–300	35–300	95–240		
GD35-250G-6-C1/D1/H1	185	95	185–300	185–300	35–300	95–240		
GD35-280G-6-C1/D1/H1	240	120	240–300	240–300	70–300	120–240		
GD35-315G-6-C1/D1/H1	95*2P	120	95*2P–150*2P	95*2P–150*2P	95*2P–150*2P	120–300		
GD35-350G-6-C1/D1/H1	95*2P	150	95*2P–150*2P	95*2P–150*2P	95*2P–150*2P	150–300		
GD35-400G-6-C1/D1/H1	150*2P	150	150*2P–300*2P	95*2P–150*2P	95*2P–150*2P	150–300		
GD35-500G-6-C1/D1/H1	95*4P	95*2P	95*4P–150*4P	95*4P–150*4P	95*4P–150*4P	95*2P–150*2P		
GD35-560G-6-C1/D1/H1	95*4P	95*4P	95*4P–150*4P	95*4P–150*4P	95*4P–150*4P	95*4P–150*4P		
GD35-630G-6-C1/D1/H1	150*4P	150*2P	150*4P–300*4P	150*4P–300*4P	150*4P–300*4P	150*4P–240*4P		

Note:

◇ Cables of the sizes recommended for the main circuit can be used in scenarios where the ambient temperature is lower than 40°C, the wiring distance is shorter than 100 m, and the current is the rated current.

◇ The terminals P1, (+), and (-) are used to connect to DC reactors and braking accessories.

D.4.3 Routing the cables

Motor cables must be arranged away from other cables. The motor cables of several VFDs can be arranged in parallel. It is recommended that you arrange the motor cables, input power cables, and control cables separately in different trays. The output dU/dt of the VFDs may increase electromagnetic interference on other cables. Do not arrange other cables and the motor cables in parallel.

If a control cable and power cable must cross each other, ensure that the angle between them is 90 degrees.

The cable trays must be connected properly and well grounded. Aluminum trays can implement local equipotential.

The following figure shows the cable arrangement distance requirements.

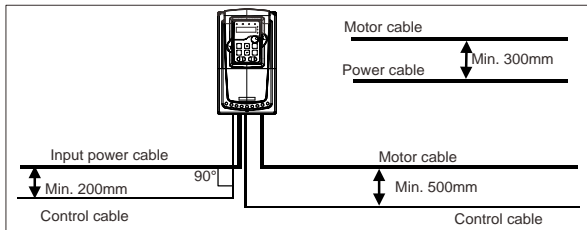

Figure D-3 Wiring layout distances

D.4.4 Insulation checking

Check the motor and the insulation conditions of the motor cable before running the motor.

1. Ensure that the motor cable is connected to the motor, and then remove the motor cable from the U, V, and W output terminals of the VFD.
2. Use a megameter of 500 V DC to measure the insulation resistance between each phase conductor and the protection grounding conductor. For details about the insulation resistance of the motor, see the description provided by the manufacturer.

Note: The insulation resistance is reduced if it is damp inside the motor. If it may be damp, you need to dry the motor and then measure the insulation resistance again.

D.5 Breaker and electromagnetic contactor

You need to add a fuse to prevent overload.

You need to configure a manually manipulated molded case circuit breaker (MCCB) between the AC power supply and VFD. The breaker must be locked in the open state to facilitate installation and inspection. The capacity of the breaker needs to be 1.5 to 2 times the rated current of the VFD.



According to the working principle and structure of breakers, if the manufacturer's regulation is not followed, hot ionized gases may escape from the breaker enclosure when a short circuit occurs. To ensure safe use, exercise extra caution when installing and placing the breaker. Follow the manufacturer's instructions.

To ensure safety, you can configure an electromagnetic contactor on the input side to control the switch-on and switch-off of the main circuit power, so that the input power supply of the VFD can be effectively cut off when a system fault occurs.

D.5.1 AC 3PH 380 V (-15%)–440 V (+10%)

Model	Breaker rated current (A)	Fuse rated current (A)	Contactor rated current (A)
GD35-1R5G-4-C1/D1/H1	15	16	10
GD35-2R2G-4-C1/D1/H1	17.4	16	10
GD35-004G-4-C1/D1/H1/H2	30	25	16
GD35-5R5G-4-C1/D1/H1/H2	45	25	16
GD35-7R5G-4-C1/D1/H1/H2	60	40	25
GD35-011G-4-C1/D1/H1/H2	78	63	32
GD35-015G-4-C1/D1/H1/H2	105	63	50
GD35-018G-4-C1/D1/H1/H2	114	100	63
GD35-022G-4-C1/D1/H1/H2	138	100	80
GD35-030G-4-C1/D1/H1/H2	186	125	95
GD35-037G-4-C1/D1/H1	228	160	120
GD35-045G-4-C1/D1/H1	270	200	135
GD35-055G-4-C1/D1/H1	315	200	170
GD35-075G-4-C1/D1/H1	420	250	230
GD35-090G-4-C1/D1/H1	480	315	280
GD35-110G-4-C1/D1/H1	630	400	315
GD35-132G-4-C1/D1/H1	720	400	380
GD35-160G-4-C1/D1/H1	870	630	450
GD35-185G-4-C1/D1/H1	630	1110	580
GD35-200G-4-C1/D1/H1	1110	630	580
GD35-220G-4-C1/D1/H1	1230	800	630
GD35-250G-4-C1/D1/H1	1380	800	700
GD35-280G-4-C1/D1/H1	1500	1000	780
GD35-315G-4-C1/D1/H1	1740	1200	900

Note: The accessory specifications described in the preceding table are ideal values. You can select accessories based on the actual market conditions, but try not to use those with lower values.

D.5.2 AC 3PH 520 V (-15%)–690 V (+10%)

Model	Breaker rated current (A)	Fuse rated current (A)	Contactor rated current (A)
GD35-022G-6-C1/D1/H1	105	63	50
GD35-030G-6-C1/D1/H1	105	63	50
GD35-037G-6-C1/D1/H1	114	100	63
GD35-045G-6-C1/D1/H1	138	100	80
GD35-055G-6-C1/D1/H1	186	125	95
GD35-075G-6-C1/D1/H1	270	200	135
GD35-090G-6-C1/D1/H1	270	200	135
GD35-110G-6-C1/D1/H1	315	200	170
GD35-132G-6-C1/D1/H1	420	250	230
GD35-160G-6-C1/D1/H1	480	315	280
GD35-185G-6-C1/D1/H1	480	315	280
GD35-200G-6-C1/D1/H1	630	400	315
GD35-220G-6-C1/D1/H1	720	400	380
GD35-250G-6-C1/D1/H1	720	400	380
GD35-280G-6-C1/D1/H1	870	630	450
GD35-315G-6-C1/D1/H1	1110	630	580
GD35-350G-6-C1/D1/H1	1110	630	580
GD35-400G-6-C1/D1/H1	1230	800	630
GD35-500G-6-C1/D1/H1	1500	1000	780
GD35-560G-6-C1/D1/H1	1740	1200	900
GD35-630G-6-C1/D1/H1	2010	1380	1035

Note: The accessory specifications described in the preceding table are ideal values. You can select accessories based on the actual market conditions, but try not to use those with lower values.

D.6 Reactors

When the voltage of the grid is high, the transient large current that flows into the input power circuit may damage rectifier components. You need to configure an AC reactor on the input side, which can also improve the current adjustment coefficient on the input side.

When the distance between the VFD and motor is longer than 50 m, the parasitic capacitance between the long cable and ground may cause large leakage current, and overcurrent protection of the VFD may be frequently triggered. To prevent this from happening and avoid damage to the motor insulator, compensation must be made by adding an output reactor. When a VFD is used to drive multiple motors, take the total length of the motor cables (that is, sum of the lengths of the motor cables) into account. When the total length is longer than 50 m, an output reactor must be added on the output side of the VFD. If the distance between the VFD and motor is 50 m to 100 m, select the reactor according to the following table. If the distance is longer than 100 m, contact INVT's technical support

technicians.

DC reactors can be directly connected to VFDs of 380 V, 37 kW or higher and the 660 V series. DC reactors can improve the power factor, avoid damage to bridge rectifiers caused due to large input current of the VFD when large-capacity transformers are connected, and also avoid damage to the rectification circuit caused due to harmonics generated by grid voltage transients or phase-control loads.

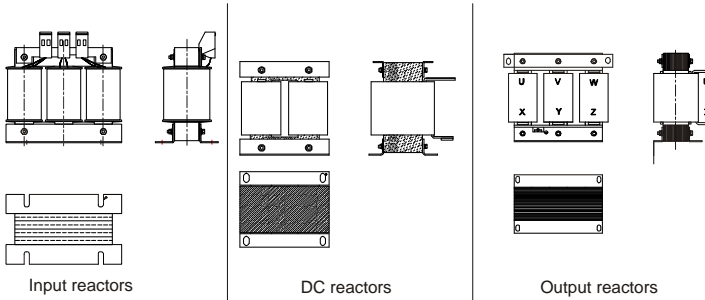

D.6.1 Reactors for AC 3PH 380 V (-15%)–440 V (+10%)

Model	Input reactor	DC reactor	Output reactor
GD35-1R5G-4-C1/D1/H1	ACL2-1R5-4	/	OCL2-1R5-4
GD35-2R2G-4-C1/D1/H1	ACL2-2R2-4	/	OCL2-2R2-4
GD35-004G-4-C1/D1/H1/H2	ACL2-004-4	/	OCL2-004-4
GD35-5R5G-4-C1/D1/H1/H2	ACL2-5R5-4	/	OCL2-5R5-4
GD35-7R5G-4-C1/D1/H1/H2	ACL2-7R5-4	/	OCL2-7R5-4
GD35-011G-4-C1/D1/H1/H2	ACL2-011-4	/	OCL2-011-4
GD35-015G-4-C1/D1/H1/H2	ACL2-015-4	/	OCL2-015-4
GD35-018G-4-C1/D1/H1/H2	ACL2-018-4	/	OCL2-018-4
GD35-022G-4-C1/D1/H1/H2	ACL2-022-4	/	OCL2-022-4
GD35-030G-4-C1/D1/H1/H2	ACL2-037-4	/	OCL2-037-4
GD35-037G-4-C1/D1/H1	ACL2-037-4	DCL2-2R2-4	OCL2-037-4
GD35-045G-4-C1/D1/H1	ACL2-045-4	DCL2-045-4	OCL2-045-4
GD35-055G-4-C1/D1/H1	ACL2-055-4	DCL2-055-4	OCL2-055-4
GD35-075G-4-C1/D1/H1	ACL2-075-4	DCL2-075-4	OCL2-075-4
GD35-090G-4-C1/D1/H1	ACL2-110-4	DCL2-090-4	OCL2-110-4
GD35-110G-4-C1/D1/H1	ACL2-110-4	DCL2-110-4	OCL2-110-4
GD35-132G-4-C1/D1/H1	ACL2-160-4	DCL2-132-4	OCL2-160-4
GD35-160G-4-C1/D1/H1	ACL2-160-4	DCL2-160-4	OCL2-200-4
GD35-185G-4-C1/D1/H1	ACL2-200-4	DCL2-200-4	OCL2-200-4

Model	Input reactor	DC reactor	Output reactor
GD35-200G-4-C1/D1/H1	ACL2-200-4	DCL2-220-4	OCL2-200-4
GD35-220G-4-C1/D1/H1	ACL2-280-4	DCL2-280-4	OCL2-280-4
GD35-250G-4-C1/D1/H1	ACL2-280-4	DCL2-280-4	OCL2-280-4
GD35-280G-4-C1/D1/H1	ACL2-280-4	DCL2-280-4	OCL2-280-4
GD35-315G-4-C1/D1/H1	ACL2-350-4	DCL2-315-4	OCL2-350-4

Note:

- ✧ The rated input voltage drop of input reactors is 2%±15%.
- ✧ The current adjustment coefficient on the input side of the VFD is higher than 90% after a DC reactor is configured.
- ✧ The rated output voltage drop of output reactors is 1%±15%.
- ✧ The preceding table describes external accessories. You need to specify the ones you choose when purchasing accessories.

D.6.2 Reactors for AC 3PH 520 V (-15%)–690 V (+10%)

VFD power	Input reactor	DC reactor	Output reactor
GD35-022G-6-C1/D1/H1	ACL2-030-6	DCL2-030-6	OCL2-030-6
GD35-030G-6-C1/D1/H1	ACL2-030-6	DCL2-030-6	OCL2-030-6
GD35-037G-6-C1/D1/H1	ACL2-055-6	DCL2-055-6	OCL2-055-6
GD35-045G-6-C1/D1/H1	ACL2-055-6	DCL2-055-6	OCL2-055-6
GD35-055G-6-C1/D1/H1	ACL2-055-6	DCL2-055-6	OCL2-055-6
GD35-075G-6-C1/D1/H1	ACL2-110-6	DCL2110-6	OCL2-110-6
GD35-090G-6-C1/D1/H1	ACL2-110-6	DCL2-110-6	OCL2-110-6
GD35-110G-6-C1/D1/H1	ACL2-110-6	DCL2-110-6	OCL2-110-6
GD35-132G-6-C1/D1/H1	ACL2-185-6	DCL2-185-6	OCL2-185-6
GD35-160G-6-C1/D1/H1	ACL2-185-6	DCL2-185-6	OCL2-185-6
GD35-185G-6-C1/D1/H1	ACL2-185-6	DCL2-185-6	OCL2-185-6
GD35-200G-6-C1/D1/H1	ACL2-250-6	DCL2-250-6	OCL2-250-6
GD35-220G-6-C1/D1/H1	ACL2-250-6	DCL2-250-6	OCL2-250-6
GD35-250G-6-C1/D1/H1	ACL2-250-6	DCL2-250-6	OCL2-250-6
GD35-280G-6-C1/D1/H1	ACL2-350-6	DCL2-350-6	OCL2-350-6
GD35-315G-6-C1/D1/H1	ACL2-350-6	DCL2-350-6	OCL2-350-6
GD35-350G-6-C1/D1/H1	ACL2-350-6	DCL2-350-6	OCL2-350-6
GD35-400G-6-C1/D1/H1	Standard configuration	DCL2-400-6	OCL2-400-6
GD35-500G-6-C1/D1/H1	Standard configuration	DCL2-560-6	OCL2-560-6
GD35-560G-6-C1/D1/H1	Standard configuration	DCL2-560-6	OCL2-560-6
GD35-630G-6-C1/D1/H1	Standard configuration	DCL2-630-6	OCL2-630-6

Note:

- ✧ The rated input voltage drop of input reactors is $2\% \pm 15\%$.
- ✧ The current adjustment coefficient on the input side of the VFD is higher than 90% after a DC reactor is configured.
- ✧ The rated output voltage drop of output reactors is $1\% \pm 15\%$.
- ✧ The preceding table describes external accessories. You need to specify the ones you choose when purchasing accessories.

D.7 Filter

J10 is not connected in factory for VFDs of 380V ($\leq 110\text{kW}$). Connect the J10 packaged with the manual if the requirements of level C3 need to be met.

J10 is connected in factory for VFDs of 380V ($\geq 132\text{kW}$), all of which meet the requirements of level C3.

Note:

Disconnect J10 in the following situations:

1. The EMC filter is applicable to the neutral-grounded grid system. If it is used for the IT grid system (that is, non-neutral grounded grid system), disconnect J10.
2. If leakage protection occurs during configuration of a residual-current circuit breaker, disconnect J10.

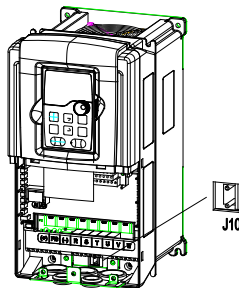

Note: Do not connect C3 filters in IT power systems.

Interference filters on the input side can reduce the interference of VFDs (when used) on the surrounding devices.

Noise filters on the output side can decrease the radio noise caused by the cables between VFDs and motors and the leakage current of conducting wires.

INVT provides some of the filters for users to choose.

D.7.1 Filter model instruction

FLT – P 04 045 L – B

Field identifier	Detailed instruction
A	FLT: VFD filter series
B	Filter type P: power supply filter L: output filter
C	Voltage degree 04: AC 3PH 380 V (-15%)–440 V (+10%) 06: AC 3PH 520 V (-15%)–690 V (+10%)
D	3-digit code indicating the rated current. For example, 015 indicates 15 A.
E	Installation type L: General H: High-performance
F	Filter application environment A: Environment Category I, C1 (EN 61800-3) B: Environment Category I, C2 (EN 61800-3) C: Environment Category II, C3 (EN 61800-3)

D.7.2 Filters for AC 3PH 380 V (-15%)–440 V (+10%)

Model	Input filter	Output filter
GD35-1R5G-4-C1/D1/H1	FLT-P04006L-B	FLT-L04006L-B
GD35-2R2G-4-C1/D1/H1		
GD35-004G-4-C1/D1/H1/H2	FLT-P04016L-B	FLT-L04016L-B
GD35-5R5G-4-C1/D1/H1/H2		
GD35-7R5G-4- C1/D1/H1/H2	FLT-P04032L-B	FLT-L04032L-B
GD35-011G-4- C1/D1/H1/H2		
GD35-015G-4-C1/D1/H1/H2	FLT-P04045L-B	FLT-L04045L-B
GD35-018G-4-C1/D1/H1/H2		
GD35-022G-4-C1/D1/H1/H2	FLT-P04065L-B	FLT-L04065L-B
GD35-030G-4-C1/D1/H1/H2		
GD35-037G-4-C1/D1/H1	FLT-P04100L-B	FLT-L04100L-B
GD35-045G-4-C1/D1/H1		
GD35-055G-4-C1/D1/H1	FLT-P04150L-B	FLT-L04150L-B
GD35-075G-4-C1/D1/H1		

Model	Input filter	Output filter
GD35-090G-4-C1/D1/H1	FLT-P04240L-B	FLT-L04240L-B
GD35-110G-4-C1/D1/H1		
GD35-132G-4-C1/D1/H1		
GD35-160G-4-C1/D1/H1	FLT-P04400L-B	FLT-L04400L-B
GD35-185G-4-C1/D1/H1		
GD35-200G-4-C1/D1/H1		
GD35-220G-4-C1/D1/H1	FLT-P04600L-B	FLT-L04600L-B
GD35-250G-4-C1/D1/H1		
GD35-280G-4-C1/D1/H1		
GD35-315G-4-C1/D1/H1	FLT-P04800L-B	FLT-L04800L-B

Note:

- ✧ The input EMI meets the C2 requirements after an input filter is configured.
- ✧ The preceding table describes external accessories. You need to specify the ones you choose when purchasing accessories.

D.7.3 Filters for AC 3PH 520 V (-15%)–690 V (+10%)

Model	Input filter	Output filter
GD35-022G-6-C1/D1/H1	FLT-P06050H-B	FLT-L06050H-B
GD35-030G-6-C1/D1/H1		
GD35-037G-6-C1/D1/H1		
GD35-045G-6-C1/D1/H1	FLT-P06100H-B	FLT-L06100H-B
GD35-055G-6-C1/D1/H1		
GD35-075G-6-C1/D1/H1		
GD35-090G-6-C1/D1/H1		
GD35-110G-6-C1/D1/H1		
GD35-132G-6-C1/D1/H1	FLT-P06200H-B	FLT-L06200H-B
GD35-160G-6-C1/D1/H1		
GD35-185G-6-C1/D1/H1		
GD35-200G-6-C1/D1/H1		
GD35-220G-6-C1/D1/H1	FLT-P06300H-B	FLT-L06300H-B
GD35-250G-6-C1/D1/H1		
GD35-280G-6-C1/D1/H1		
GD35-315G-6-C1/D1/H1		
GD35-350G-6-C1/D1/H1	FLT-P06400H-B	FLT-L06400H-B
GD35-400G-6-C1/D1/H1	FLT-L061000H-B	FLT-L061000H-B
GD35-500G-6-C1/D1/H1		
GD35-560G-6-C1/D1/H1		
GD35-630G-6-C1/D1/H1		



Note:

- ✧ The input EMI meets the C2 requirements after an input filter is configured.
- ✧ The preceding table describes external accessories. You need to specify the ones you choose when purchasing accessories.

D.8 Braking system

D.8.1 Braking component selection

When a VFD driving a high-inertia load decelerates or needs to decelerate abruptly, the motor runs in the power generation state and transmits the load-carrying energy to the DC circuit of the VFD, causing the bus voltage of the VFD to rise. If the bus voltage exceeds a specific value, the VFD reports an overvoltage fault. To prevent this from happening, you need to configure braking components.

	<ul style="list-style-type: none"> ✧ The design, installation, commissioning, and operation of the device must be performed by trained and qualified professionals. ✧ Follow all the "Warning" instructions during the operation. Otherwise, major physical injuries or property loss may be caused. ✧ Only qualified electricians are allowed to perform the wiring. Otherwise, damage to the VFD or braking components may be caused. ✧ Read the braking resistor or unit instructions carefully before connecting them to the VFD. ✧ Connect braking resistors only to the terminals PB and (+), and braking units only to the terminals (+) and (-). Do not connect them to other terminals. Otherwise, damage to the brake circuit and VFD and fire may be caused.
	Connect the braking components to the VFD according to the wiring diagram. If the wiring is not properly performed, damage to the VFD or other devices may be caused.

D.8.1.1 Braking units for AC 3PH 380 V (-15%)–440 V (+10%)



Goodrive350 series VFDs of 380 V, 37 kW or lower are equipped with built-in braking units, and those of 380 V, 45 kW or higher need to be configured with external braking units. Select braking resistors according to the specific requirements (such as the braking torque and braking usage requirements) on site.

Model	Braking unit model	Braking resistor value matched with 100% braking torque (Ω)	Dissipation power of braking resistor (kW)			Min allowed braking resistor (Ω)
			10% braking usage	50% braking usage	(80% braking usage)	
GD35-1R5G-4-C1/D1/H1	Built-in braking unit	326	0.23	1.1	1.8	170
GD35-2R2G-4-C1/D1/H1		222	0.33	1.7	2.6	130
GD35-004G-4-C1/D1/H1/H2		122	0.6	3	4.8	80
GD35-5R5G-4-C1/D1/H1/H2		89	0.75	4.1	6.6	60
GD35-7R5G-4-C1/D1/H1/H2		65	1.1	5.6	9	47

Model	Braking unit model	Braking resistor value matched with 100% braking torque (Ω)	Dissipation power of braking resistor (kW)			Min allowed braking resistor (Ω)
			10% braking usage	50% braking usage	80% braking usage	
GD35-011G-4-C1/D1/H1/H2		44	1.7	8.3	13.2	31
GD35-015G-4-C1/D1/H1/H2		32	2	11	18	23
GD35-018G-4-C1/D1/H1/H2		27	3	14	22	19
GD35-022G-4-C1/D1/H1/H2		22	3	17	26	17
GD35-030G-4-C1/D1/H1/H2		17	5	23	36	17
GD35-037G-4-C1/D1/H1	DBU100H-060-4	13	6	28	44	11.7
GD35-045G-4-C1/D1/H1	DBU100H-110-4	10	7	34	54	6.4
GD35-055G-4-C1/D1/H1		8	8	41	66	
GD35-075G-4-C1/D1/H1		6.5	11	56	90	
GD35-090G-4-C1/D1/H1	DBU100H-160-4	5.4	14	68	108	4.4
GD35-110G-4-C1/D1/H1		4.5	17	83	132	
GD35-132G-4-C1/D1/H1	DBU100H-220-4	3.7	20	99	158	3.2
GD35-160G-4-C1/D1/H1	DBU100H-320-4	3.1	24	120	192	2.2
GD35-185G-4-C1/D1/H1		2.8	28	139	222	
GD35-200G-4-C1/D1/H1		2.5	30	150	240	
GD35-220G-4-C1/D1/H1	DBU100H-400-4	2.2	33	165	264	1.8
GD35-250G-4-C1/D1/H1		2.0	38	188	300	
GD35-280G-4-C1/D1/H1	Two	3.6*2	21*2	105*2	168*2	2.2*2
GD35-315G-4-C1/D1/H1	DBU100H-320-4	3.2*2	24*2	118*2	189*2	

Note:

- ✧ Select the resistor and power of the braking unit according to the data our company provided.
- ✧ The braking resistor may increase the braking torque of the VFD. The preceding table describes the resistance and power for 100% braking torque, 10% braking usage, 50% braking usage, and 80% braking usage. You can select the braking system based on the actual operation conditions.
- ✧ When using an external braking unit, set the braking voltage class of the braking unit properly by referring to the manual of the dynamic braking unit. If the voltage class is set incorrectly, the VFD may not run properly.

	Do not use braking resistors whose resistance is lower than the specified minimum resistance. VFDs do not provide protection against overcurrent caused by resistors with low resistance.
	In scenarios where braking is frequently implemented, that is, the braking usage is greater than 10%, you need to select a braking resistor with higher power as required by the operation conditions according to the preceding table.



D.8.1.2 Braking units for AC 3PH 520 V (-15%)–690 V (+10%)

External braking units need to be configured for Goodrive350 series VFDs of 660 V. Select braking resistors according to the specific requirements (such as the braking torque and braking usage requirements) on site.

Model	Braking unit model	Braking resistor value matched with 100% braking torque (Ω)	Dissipation power of braking resistor (kW)			Min allowed braking resistor (Ω)
			10% braking usage	50% braking usage	80% braking usage	
GD35-022G-6-C1/D1/H1	DBU100H-110-6	55	4	17	27	10.0
GD35-030G-6-C1/D1/H1		40.3	5	23	36	
GD35-037G-6-C1/D1/H1		32.7	6	28	44	
GD35-045G-6-C1/D1/H1		26.9	7	34	54	
GD35-055G-6-C1/D1/H1		22.0	8	41	66	
GD35-075G-6-C1/D1/H1		16.1	11	56	90	
GD35-090G-6-C1/D1/H1		13.4	14	68	108	
GD35-110G-6-C1/D1/H1		11.0	17	83	132	
GD35-132G-6-C1/D1/H1	DBU100H-160-6	9.2	20	99	158	6.9
GD35-160G-6-C1/D1/H1		7.6	24	120	192	
GD35-185G-6-C1/D1/H1	DBU100H-220-6	6.5	28	139	222	5.0
GD35-200G-6-C1/D1/H1		6.1	30	150	240	
GD35-220G-6-C1/D1/H1		5.5	33	165	264	
GD35-250G-6-C1/D1/H1	DBU100H-320-6	4.8	38	188	300	3.4
GD35-280G-6-C1/D1/H1		4.3	42	210	336	
GD35-315G-6-C1/D1/H1		3.8	47	236	378	
GD35-350G-6-C1/D1/H1		3.5	53	263	420	
GD35-400G-6-C1/D1/H1	DBU100H-400-6	3.0	60	300	480	2.8
GD35-500G-6-C1/D1/H1	Two DBU100H-320-6	4.8*2	38*2	188*2	300*2	3.4*2
GD35-560G-6-C1/D1/H1		4.3*2	42*2	210*2	336*2	
GD35-630G-6-C1/D1/H1		3.8*2	47*2	236*2	378*2	

Note:

- ✧ Select braking resistors according to the resistance and power data provided by our company.
- ✧ The braking resistor may increase the braking torque of the VFD. The preceding table describes the resistance and power for 100% braking torque, 10% braking usage, 50% braking usage, and 80% braking usage. You can select the braking system based on the actual operation conditions.
- ✧ When using an external braking unit, set the braking voltage class of the braking unit properly by referring to the manual of the dynamic braking unit. If the voltage class is set incorrectly, the VFD may not run properly.

	<p>Do not use braking resistors whose resistance is lower than the specified minimum resistance. VFDs do not provide protection against overcurrent caused by resistors with low resistance.</p>
	<p>In scenarios where braking is frequently implemented, that is, the braking usage is greater than 10%, you need to select a braking resistor with higher power as required by the operation conditions according to the preceding table.</p>

D.8.2 Braking resistor cable selection

Braking resistor cables need to be shielded cables.

D.8.3 Braking resistor installation

All resistors need to be installed in places with good cooling conditions.

	<p>The materials near the braking resistor or braking unit must be non-flammable. The surface temperature of the resistor is high. Air flowing from the resistor is of hundreds of degrees Celsius. Prevent any materials from coming into contact with the resistor.</p>
---	---

Installation of the braking resistor:

	<ul style="list-style-type: none"> ◇ VFDs of 380 V, 37 kW or lower need only external braking resistors. ◇ PB and (+) are the terminals for connecting braking resistors.
---	---

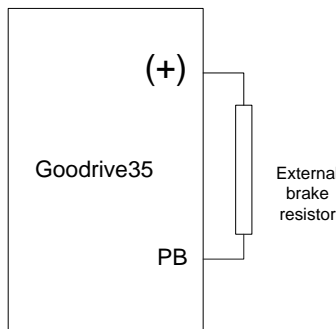

Installation of braking units:

	<ul style="list-style-type: none"> ◇ The VFDs of 380 V (≥ 37 kW) need external braking units. ◇ The VFDs of 660 V need external braking units. ◇ (+), (-) are the terminals for connecting braking units. ◇ The connection cables between the (+) and (-) terminals of a VFD and those of a braking unit must be shorter than 5 m, and the connection cables between the BR1 and BR2 terminals of a braking unit and the terminals of a braking resistor must be shorter than 10 m.
---	---

The following figure shows the connection of one VFD to a dynamic braking unit.

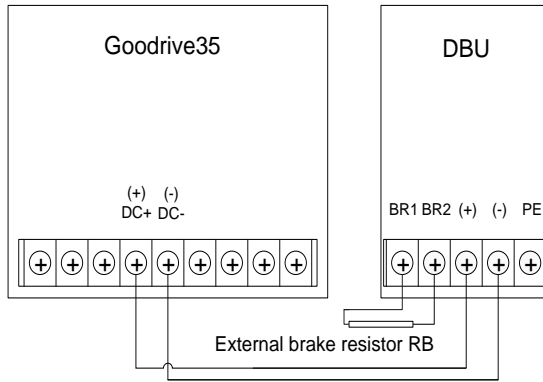

Appendix E Further information

E.1 Product and service queries

Should you have any queries about the product, contact the local INVT office. Provide the model and serial number of the product you query about. You can visit www.invt.com to find a list of INVT offices.

E.2 Feedback on INVT VFD manuals

Your comments on our manuals are welcome. Visit www.invt.com, directly contact online service personnel or choose **Contact Us** to obtain contact information.

E.3 Documents on the Internet

You can find manuals and other product documents in PDF format on the Internet. Visit www.invt.com and choose **Support > Download**.



Service line: 86-755-23535967 E-mail: overseas@invt.com.cn Website: www.invt.com

The products are owned by **Shenzhen INVT Electric Co.,Ltd.**

Two companies are commissioned to manufacture: (For product code, refer to the 2nd/3rd place of S/N on the name plate.)

Shenzhen INVT Electric Co., Ltd. (origin code: 01)

Address: INVT Guangming Technology Building, Songbai Road,
Matian, Guangming District, Shenzhen, China

INVT Power Electronics (Suzhou) Co., Ltd. (origin code: 06)

Address: 1# Kuntun Mountain Road, Science&Technology Town,
Gaoxin District, Suzhou, Jiangsu, China

- Industrial Automation:** ■ HMI ■ PLC ■ VFD ■ Servo System
- Elevator Intelligent Control System ■ Rail Transit Traction System
- Energy & Power:** ■ UPS ■ DCIM ■ Solar Inverter ■ SVG
- New Energy Vehicle Powertrain System ■ New Energy Vehicle Charging System
- New Energy Vehicle Motor



66001-00097

Copyright© INVT.

Manual information may be subject to change without prior notice.

202205 (V4.0)