



# Operation **Manual**

## **EC160 Elevator Intelligent Integrated Machine**



## Preface

EC160 elevator intelligent integrated machine is the new intelligent elevator control system with drive technology, control technology and network communication technology. Applying advanced frequency vector control technology, intelligent elevator control technology and network communication technology, our products integrate drive, control and management of the elevator to improve the safety and reliability, operation, economy and individual design.

Main features:

- Integrated design, simple wiring and easy debugging
- The highest floor: 36<sup>th</sup> floor    Max. speed: 3m/s
- Direct stop in the principle of distance control, automatic generation of N curves
- Automatic identification running of low floor station
- Advanced starting compensation of non-load sensor
- Synchronous and asynchronous master; static and dynamic self-tuning function
- Vector control
- Encoder interface of synchronous and asynchronous master, achieving speed control and position control with high accuracy
- CAN serial communication, improving data transmission capacity and enhancing communication reliability
- Automatic car position correction, forced deceleration switch monitoring function, top-hitting and bottom-clashing protection
- Single-phase AC220V low voltage aid function, low cost
- LED displaying and operation, compatible manual controller and PC debugging software
- Multiple safety protection; meet the standards of EN81 and GB7588
- EMC meets C3 standards
- Redundancy safety design
- Intelligent, network-based control group control, as much as 8
- Optional 485 communication

If the product is ultimately used for military affairs or manufacture of weapon, it will be listed on the export control formulated by ***Foreign Trade Law of the People's Republic of China***. Rigorous review and necessary export formalities are needed when exported.

Our company reserves the right to update the information of our products without notice.

## Content

<b>Chapter 1 EC160 configuration.....</b>	<b>1</b>
1.1 Hardware configuration .....	1
1.2 Standard functions of software .....	2
1.3 Optional functions of software .....	10
<b>Chapter 2 Safety precautions and notices.....</b>	<b>12</b>
2.1 Safety marks.....	12
2.2 Reader group.....	12
2.3 Warning marks.....	12
2.4 Safety precautions .....	13
2.4.1 Unpacking inspection .....	13
2.4.2 Disassembly and assembly .....	13
2.4.3 Connection precautions.....	13
2.4.4 Running precautions .....	14
2.4.5 Maintenance and inspection precautions.....	15
2.4.6 Other precautions .....	15
<b>Chapter 3 Product overview .....</b>	<b>16</b>
3.1 Model description.....	16
3.2 Name plate .....	16
3.3 Power selection .....	16
3.4 Technical specifications .....	17
3.5 Delivery confirmation .....	18
3.6 Digitron displaying and operation instruction.....	19
3.7 Running environment.....	20
3.7.1 Temperature&humidity .....	20
3.7.2 Altitude.....	20
3.7.3 Other environmental requirements .....	20
<b>Chapter 4 Installation and wiring.....</b>	<b>21</b>
4.1 Dimensions.....	22
4.1.1 Terminals instruction .....	23
4.2 Terminals of main circuit.....	24
4.2.1 Terminal arrangement .....	24
4.2.2 Function instruction .....	24
4.2.3 Specification of the main circuit leads .....	25
4.2.4 Configuration precautions .....	25
4.2.5 Connection of braking circuit of intelligent integrated machine in main circuit.....	26
4.2.6 Connection of RBU series energy feedback unit.....	26
4.2.7 Connection of PE terminal.....	27
4.3 Terminals of control circuit.....	27
4.3.1 Definition of terminals.....	27

4.3.2	Specification of digital input signal .....	31
4.3.3	Specification of relay digital output signal .....	31
4.4	Encoder wiring .....	31
4.4.1	Encoder wiring of asynchronous master .....	31
4.4.2	Encoder wiring of synchronous master .....	31
4.5	System installation and configuration .....	32
4.5.1	Electrical installation of hoistway .....	32
4.5.2	Installation position of hoistway switch.....	33
4.5.3	Connection precautions of peripheral devices.....	36
4.5.4	CAN communication configuration.....	36
4.6	Installation guideline to EMC compliance .....	38
4.6.1	General knowledge of EMC.....	38
4.6.2	EMC features of inverter .....	38
4.6.3	EMC installation guideline .....	39
4.6.4	Installation specification .....	40
<b>Chapter 5</b>	<b>Debugging tools.....</b>	<b>41</b>
5.1	Instruction.....	41
5.1.1	Main controlling interface .....	41
5.1.2	Fault record .....	41
5.1.3	Parameters setting.....	41
5.1.4	Password setting.....	41
5.1.5	System autotuning .....	41
5.1.6	Data management .....	41
5.2	Connection method.....	42
5.3	Keys and LED indicator.....	42
5.3.1	Key definition .....	42
5.3.2	Manual controller and LED indicator.....	43
5.4	Operation procedure flowchart .....	43
5.5	Simple manual controller.....	44
5.5.1	Introduction.....	44
5.5.2	Key instruction .....	44
5.5.3	LED indicator instruction .....	45
5.5.4	Comparison table of digitron word .....	45
5.5.5	Operation procedure flowchart .....	47
5.5.6	Monitoring instruction .....	47
5.5.7	Corresponding list of function parameters.....	49
<b>Chapter 6</b>	<b>Function parameters.....</b>	<b>73</b>
6.1	Original debugging interface .....	73
6.2	System monitoring .....	73
6.2.1	System monitoring---calling and running state .....	73
6.2.2	System monitoring---random running .....	74

6.2.3 System monitoring---drive state .....	74
6.2.4 System monitoring---main controller .....	75
6.2.5 System monitoring---car controller .....	76
6.3 Fault history record .....	76
6.4 Language selection .....	77
6.5 Parameters setting inquiry.....	77
6.5.1 Parameters setting---master drive control .....	78
6.5.2 Parameters setting---speed and deceleration distance .....	80
6.5.3 Parameters setting---motor parameters .....	83
6.5.4 Parameters setting---encoder parameters .....	85
6.5.5 Parameters setting---running comfortability .....	88
6.5.6 Parameters setting---elevator protection parameters .....	95
6.5.7 Parameters setting---communication setting.....	98
6.5.8 Parameters setting---drive information.....	101
6.5.9 Parameters setting---floor setting .....	102
6.5.10 Parameters setting---floor displaying setting .....	103
6.5.11 Parameters setting---logic setting of I/O control board.....	107
6.5.12 Parameters setting---logic setting of car control board .....	110
6.5.13 Parameters setting---front door stopping floor.....	112
6.5.14 Parameters setting---rear door stopping floor.....	115
6.5.15 Parameters setting---front/rear door stopping floor.....	116
6.5.16 Parameters setting---parallel and group control setting .....	117
6.5.17 Parameters setting---time setting.....	119
6.5.18 Parameters setting---function setting .....	124
6.5.19 Parameters setting---calling signal.....	136
6.5.20 Parameters setting---system monitoring .....	137
6.5.21 Parameters setting---hoistway information.....	139
6.6 Password setting .....	140
6.7 System autotuning .....	140
6.8 Data management .....	140
6.9 System information .....	141
<b>Chapter 7 Running at slow speed .....</b>	<b>142</b>
7.1 Inspection before power on .....	142
7.1.1 Machinery assembly, inspection and confirmation .....	142
7.1.2 Electrical assembly, inspection and confirmation .....	142
7.1.3 Inspection of the encoder assembly .....	143
7.2 Inspection after power on .....	144
7.3 Static self-tuning of the synchronous motor .....	145
7.4 Rotating autotuning of the motor .....	149
7.5 Inspection running.....	152
<b>Chapter 8 Debugging at fast speed.....</b>	<b>153</b>

8.1 Inspection and confirmation of the electrical assembly .....	153
8.2 Power on and check .....	153
8.3 Parameter check.....	155
8.4 Autotuning of the hoistway position .....	155
8.5 Autotuning of the hoistway position by the up/down button .....	156
8.6 Run at fast speed.....	157
8.7 S Curve adjustment .....	158
8.8 Leveling adjustment .....	158
8.9 Comfortability.....	159
8.9.1 Vector control of the sequence in fast-running .....	159
8.9.2 Adjustment of non-weighing compensation starting .....	160
8.9.3 Adjustment of the speed loop .....	160
8.9.4 Adjustment of the current loop.....	160
8.9.5 Motor noise.....	161
8.9.6 Relative parameters .....	161
8.9.7 Adjustment of weighing compensation.....	161
<b>Chapter 9 Complete product description .....</b>	<b>164</b>
9.1 Instruction of EC-CTB .....	164
9.1.1 Installation dimension.....	164
9.1.2 Interface definition.....	165
9.1.3 DIP instruction .....	165
9.1.4 Settings of configuration.....	166
9.2 Instruction of EC-CCB.....	166
9.2.1 Installation dimension.....	167
9.2.2 Interface definition.....	167
9.2.3 Car command button and connection of the indicators.....	169
9.2.4 Car open button and connection of the indicators .....	169
9.2.5 Car close button and connection of the indicators.....	169
9.3 Instruction of DC-03F.....	170
9.3.1 Installation dimension.....	170
9.3.2 Interface definition.....	171
9.3.3 Terminal connection of DC-03F .....	172
9.3.4 Parameters setting of DC-03F .....	172
9.3.5 Function setting of the displaying board.....	172
9.3.6 Displaying table of elevator state .....	173
9.3.7 Displaying pictures.....	175
9.4 Instruction of MC-GCL .....	176
9.4.1 Installation dimension.....	177
9.4.2 Configuration .....	177
9.4.3 Specification of the connectors.....	178
9.4.4 Electrical specifications .....	178

9.4.5 Definition of the input/output interface .....	179
9.4.6 Definition of jumper terminal.....	180
9.4.7 Instruction of LED .....	180
9.4.8 Diagram of communication interface .....	181
9.4.9 Debugging .....	182
9.4.10 Precautions for separate standby of bias floors.....	191
9.5 Instruction of EC-RDB.....	192
9.5.1 Installation dimension.....	192
9.5.2 Configuration .....	193
9.5.3 Specification of the connectors.....	193
9.5.4 Electrical specifications .....	193
9.5.5 Definition of the input/output interface .....	193
9.5.6 Instruction of LED .....	194
9.5.7 Wiring diagram of EC-RDB and peripheral interface.....	195
<b>Chapter 10 Maintenance and hardware diagnosis.....</b>	<b>196</b>
10.1 Maintenance intervals .....	196
10.2 Cooling fan .....	199
10.3 Capacitors .....	199
10.3.1 Reforming the capacitors.....	199
10.3.2 Change electrolytic capacitors.....	201
10.4 Power cable.....	201
<b>Chapter 11 Fault code .....</b>	<b>202</b>
<b>Chapter 12 Appendix.....</b>	<b>219</b>
12.1 10-2-16 binary table .....	219
12.2 Definition table .....	219

## Chapter 1 EC160 configuration

### 1.1 Hardware configuration

No.	Name	Model	Application	Qty.	Position	Remarks
1	EC160 elevator intelligent integrated machine	To the actual use	Motor drive control and elevator logic control	1 for each elevator	Elevator control cabinet	Equipped, select model according to the power and rated current
2	Manual controller	EC160-PAD	For controller debugging		EC160 elevator intelligent integrated machine	Optional (compatible with EC100)
3	Car top board	EC-CTB	For the signal acquisition in the car and door control	1 for each elevator, the highest 64-floor	Top of the car	Standard
4	Instruction extension board of car top	EC-CCB	For calling button extension at the car top	Extend 16 floors for the 1 <sup>st</sup> board, 20 floors for additional 1	Control box	Standard
5	Displaying board in the car	DC-03F	For displaying in the car	1 for each elevator	Control box	Standard
		DC-07F				
6	Calling displaying board	DC-03F	For calling and floor displaying	1 for each calling	Calling box	Standard
		DC-07F				
7	Ethernet module	PA_DP/E	Ethernet monitoring	1 for each elevator	EC160 integrated machine	Optional
8	Group control board	MC-GCL	For group control communication	1 for each elevator	Control cabinet of the elevator	Optional



## 1.2 Standard functions of software

No.	Type	Function name	Function instruction	Remarks
1	System	Direct stop operation	According to the distance control principle, generate a running curve	Standard
2		Internal pre-weighing compensation	External weighing compensation device is unnecessary when applying speed loop and position loop	Standard
3		Autotuning of the master	Static and dynamic autotuning	Standard
4		Hoistway height autotuning	Hoistway information autotuning before first running, including the height of each floor and the position of forced DEC switches.	Standard
5		Full selective	In automatic or attendant state, the elevator will respond to the car command signal and the up/down calling button signal during running at the same time. The passengers at any floor can call the elevator by recording the up/down calling signal.	Standard
6		Parallel operation	Connect the corresponding CAN communication wires to realize parallel operation	Function selection
7		Real-time clock management	Real-time clock chip, can work for 3 years without power	Standard
8		Manual operator	LCD operator: Chinese/English menu, can carry out parameters setting, fault inquiry, state monitoring and parameters uploading/downloading; simple operator: unavailable parameters uploading/downloading	Optional
9	Protection	OC protection	Protect and stop when overcurrent	Standard
10		OV protection	Protect and stop when overvoltage	Standard
11		OL protection	Protect and stop when overload	Standard
12		OL protection	The elevator will keep opening when the elevator is overload in non-inspection state and the buzzer will alarm. Note: Before the	Standard

No.	Type	Function name	Function instruction	Remarks
			door lock closes, the overload switch will act and the elevator opens the door reversely; after the door lock closes, overload protection will cancel.	
13		Overspeed protection	Ensure the running speed is in the safe range.	Standard
14		Bus voltage protection	Protect and stop when bus undervoltage or overvoltage	Standard
15		Phase loss protection	Protect and stop when input or output phase loss	Standard
16		To-ground short-circuit detection	Inspect U, V and W when powering on	Standard
17		Converting overheating protection	Protect and stop when converting module overheating	Standard
18		Rectification overheating protection	Protect and stop when rectification module overheating	Standard
19		Motor overheating protection	If the thermal protection signal acts, the elevator will stop and open at the nearest leveling position. The elevator will begin to work after the time set by the thermal protection delay	Standard
20		Opening protection in non-door area	The system forbids opening in non-door area	Standard
21		Adhesion protection of the door switch	Protect, open the door at lower limit arrival when the door switch is adhesive	Standard
22		Door beam protection	In the process of closing, if the door is blocked, it will open the door Note: The function RSE will cancel automatically in fire operation and the SE is effective (RSE is the front door beam for the single door operator).	Standard

No.	Type	Function name	Function instruction	Remarks
23		Split-level protection	The elevator returns to the ground floor for correction when split-level	Standard
24		Encoder feedback detection protection	The system judges the current height and speed by high speed counting. In running state, if no encoder feedback, the elevator will stop automatically to avoid top-hitting or bottom-clashing	Standard
25		Reverse running protection	The system identifies the direction by high speed counting. The elevator will stop automatically if the running direction is different from the command direction	Standard
26		Entire running time protection	If the elevator runs for the entire time in non-inspection state and the leveling switch has no action, the car will stop running	Standard
27		Feedback detection of brake travel switch	Detect the switch. If abnormal, protect automatically. 20 detect brake travel switch is defined by F0_13 LINE2, 36 dual brake detection is defined by F0_12 and 39 triple brake detection is defined by F0_14	Standard
28		Contact detection of running contactor	Detect the switch. If abnormal, protect automatically	Standard
29		Contact detection of brake contactor	Detect the switch. If abnormal, protect automatically	Standard
30		Contact detection of door lock contactor	Detect the circuit. If off, protect automatically	Optional
31		Contact detection of safety contactor	Detect the circuit. If off, protect automatically	Optional
32		Door lock off protection	If the door lock circuit is off, protect automatically and output close signal. If the drive locks IGBT immediately, 137 fault may occur usually	Standard
33		Lock short circuit protection	In automatic running mode, detect whether the door lock is off. If abnormal, protect automatically	Standard

No.	Type	Function name	Function instruction	Remarks
34	Running mode	Inspection running	Operational function	Standard
35		Inspection speed limit	The speed switches to the low speed of 50mm/s when the elevator runs at the inspection speed to the position of low speed forced deceleration switches.	Standard
36		Attendant operation	Operate on the attendant switch in the control box. The door will not close automatically in this mode until the attendant presses the close button by manual. The buzzer alarms and the internal command flashes when outside calling.	Standard
37		Attendant direction switching	Change the direction by the UP/DOWN buttons or DS switch in the control box	Standard
38		Attendant+XPM	If A1_00=2, close after holding and pressing the close button while open after releasing the button in attendant state	Function selection
39		Attendant+Non-stop	In the attendant state, the elevator will not respond to any calling after the non-stop switch acts	Standard
40		Full load non-stop	In automatic running state, the elevator will not respond to any calling at full load. But the calling can be recorded; the outside calling can open the door. If the non-stop button acts, the calling cannot be recorded. The door can be closed by pressing close button and attendant is directional.	Standard
41		Light load anti-disturbance function	In LL switch action, if the commands in the car exceed the set value, the system will clear all commands after running once	Function selection
42		Independent running	The system will enter into the specific running mode by switching on the independent running switch	Function selection
43		Calling VIP running	When enabling lock elevator signal of calling board, the elevator will shield calling	Function selection

No.	Type	Function name	Function instruction	Remarks
			inside and outside, go straight to the floor triggering calling VIP running, and keep opening. When the elevator responds to one inside calling after closed manually, it will exit calling VIP running.	
44		Self leveling run	If the elevator is in non-inspection state and does not stop in the leveling area, the elevator will return to the leveling and open the door	Standard
45		UPS running	2 optional running modes: 220V UPS power switching by F0_22 (need to detect UPS output feedback and bus fall and set KPWR logic point into normally closed); UPS automatic switching (not limited by UPS voltage and KPWR logic point). Determine the running direction according to the load. Power-off input signal is present in the controller, and when the power is off, start UPS function automatically to open the door after low speed leveling.	Function selection
46		Automatically return to the home floor	In non-attendant running mode , automatic returning signal is valid. If there is no command, the elevator will return to the home floor after the delay time. The elevator can enter standby by F0_18.	Function selection
47		Lock elevator	In running state, the lock switch acts to clear all outside calling record. The elevator runs normally and returns to the home floor after responding to all recorded commands in the car. After that, the elevator stops and turns off the light and fan. The elevator reruns after lock switch is reset.	Standard
48		Fire evacuation	In running state, the fire switch acts to clear	Standard

No.	Type	Function name	Function instruction	Remarks
		operation	all calling records and run to the home floor at the fastest speed. After that, output fire signal to keep the door open. If the elevator is running reversely, stop at the nearest leveling position and drive to the home floor and keep the door open.	
49		Fire service	2 modes of fire service after the elevator returns to the home floor: a. fire fighter action by switching the switch in the control box; b. fire fighter action after the waiting delay time. Various modes can be selected by F0_03 and the door will be closed by the close button for fire (car top instruction board FRCL).	Function selection
50		Seismic operation	When the input signal acts, the elevator will stop and open at the nearest leveling position.	Function selection
51		Test running	The function is used in debugging or a fatigue test of a new elevator. Operate the elevator in close mode by F0_16 and shield outside calling.	Function selection
52		Arrival gong	Ring when the elevator arrives at the door area.	Function
53		Light and fan off when stand-by	The light and fan will be off during free energy-saving delay T0_03 when the door is closed and no internal command and outside calling signal. The light and fan will be on automatically in command response.	Function selection
54	Door operator	Inspection open/close door	If the door lock circuit is off, press up/down button to get the closing command. When the circuit is on, the elevator will run up/down. If the elevator stops at the door area, press the up/down button at the same time to get	Standard

No.	Type	Function name	Function instruction	Remarks
			the opening command and the elevator will open the door.	
55		Repeated open/close door	If the door of the elevator is not closed after closing for 20 seconds, the elevator will open the door. After repeating for 5 times, it will keep closing. If the door closes but the lock fails after closing for 10 seconds, the elevator will open the door. After repeating for 5 times, it will keep opening.	Standard
56		Automatic control in opening hours	In non-attendant mode, the elevator will open the door automatically when arrived. The opening time can be delayed by setting T0_00.	Function selection
57		Opening delay button	The elevator will keep opening by pressing the open button (DOD) for the set keeping time of opening delay T0_16 (The parameter relates to multi-function output F0_15=1x and F0_07=1, if any change is needed, set T0_16 to 0) while it will close by pressing the close button.	Function selection
58		Hall opening	When the car stops at some floor, the door will open when pressing the opening button.	Standard
59		Internal command opening	Press the button to open the door if the elevator is in the leveling position.	Function selection
60		Pre-close of the closing button	Press closing button in the automatic state to close the door in advance.	Standard
61		Closed maintenance function	Set closing maintenance according to the types of door operator F0_02.	Function selection
62		Service floor setting	Set the stopping floor and closing/ opening state.	Function selection
63		Front/rear door service	Service floor setting through parameters	Function selection

No.	Type	Function name	Function instruction	Remarks
64		Vice control box operation	With the same button and function with the main control box, need to set F0_09 to 0.	Function selection
65		Hand door control	To avoid short circuit of the lock, disconnect the lock once before fast running and set F0_01 to 1.	Function selection
66	Others	LED display	2 digit, display floors and fault codes	Standard
67		Floor displaying	Dot matrix displaying	Standard DC-03A
68		Running direction displaying	Rolling displaying shows the running direction.	Standard DC-03A
69		Floor displaying setting	Set the characters of floor displaying through parameters.	Function selection
70		Fault history clearance	The system will record the latest 30 faults, including the fault time, fault code, floor information.	Standard
71		Error in internal command cancel	Pressing the button twice can cancel the internal command. The function is enabled by setting F0_16 to 16.	Standard
72		Reverse automatic number clearance	Select whether to clear the previous reverse commands by F0_18 when the elevator is arrived to the terminal floor or the running direction is changed.	Function selection
73		Failure diagnosis of hoistway autotuning	The elevator can not run without correct hoistway data.	Standard
74		Automatic car height correction	The system will correct the position data at the terminal door area and leveling switch position according to the autotuning data.	Standard
75		Leveling adjustment	Adjust the leveling precision.	Standard
76	Current ramp clearance	In the application of permanent magnet synchronous motor, the maintenance current is cleared through ramp to avoid abnormal noise. Setting P5_12 can delay current ramp clearance.	Standard	



No.	Type	Function name	Function instruction	Remarks
77		Strong brake contactor	The brake contactor and strong brake contactor output at the same time. After the set delay, the strong brake contactor is disconnected.	Function selection
78		Independent star-delta control	Set F0_13 to 37, Y3 and Y1 output together and the delay will be cancelled after disconnecting the contactors at stop.	Function selection

### 1.3 Optional functions of software

No.	Function name	Function instruction	Remarks
1	Releveling after door opening	When the floor of the elevator is high, because of the flexibility of wire ropes, the leveling is inaccurate when the passengers enter or get off the elevator, so the system will open the door and level at low speed.	Configure EC-RDB
2	Arrival light outside the hall	The corresponding arrival light outputs when the elevator leveling or calling direction to inform the arrival and running direction. The up light flickers at the interval of 0.5s while the down light flickers at the interval of 1s until the lock is on or the direction is cancelled. The function is available for 485 communication calling board DC-07F.	Configure outside forecast light and relay board
3	Arrival gong outside the hall	Arrival gong is installed in each floor. It rings when the elevator is in the door area. In the up/down arrival, it rings once and twice to inform the arrival and running direction. The function is available for 485 communication calling board DC-07F.	Configure arrival gong outside the hall
4	Voice announcement	The current floor number and running direction will be announced when the elevator is in the door area.	Optional voice board
5	General/special IC card in the car for floor service control	There is a card reader on the control box if configuring the function. The user can only record the authorized entering command by swiping the card in the car.	Optional IC card
6	IC card outside	There is a card reader on the calling box if configuring the	Optional IC



No.	Function name	Function instruction	Remarks
	the hall for calling service control	function. The user can only record the calling command with a card.	card
7	Single door operator and single control box	Default configuration	Configure single control box
8	Single door operator and dual control box	Use one EC-CTB and two EC-CCB, the buttons and lights of two control boxes have the same connection. Need to short circuit the input terminal of car top board BAK.	Configure dual control box
9	Dual door operator and single control box	In conditions that there is only front or rear door, and the doors both open or close simultaneously. (Select dual control box when either front door or rear door controls independently.)	Configure single control box
10	Dual door operator and dual control box (independent front/rear door control)	Use one EC-CTB and two EC-CCB. Front door opens in response to front door calling or for the open button or inside command of main control box when landing. Rear door opens in response to rear door calling or for the open button or inside command of sub control box when landing. Need to set F0_09 to 0.	Configure dual control box
11	Remote monitoring	Monitor the floor position, running direction and fault state at real time in the remote monitoring center. Support 3G network.	Configure according to actual plan
12	GPRS remote alarm	After setting and connecting DM-03, elevator fault will be informed to the monitoring center and the short message will be sent to the maintainer.	Configure DM-03
13	Ethernet real-time monitoring	Monitor the running data of the elevator at real time (sample at the fastest 0.5ms) through PA_DP/E	Configure PA_DP/E
14	Group control running	As many as 8 elevators	Configure MC-GCL

## Chapter 2 Safety precautions and notices

This manual describes how to use the product correctly. Read this manual carefully before using (installation, wiring, running, maintenance and inspection). Please use the product after mastering the safety precautions.

### 2.1 Safety marks

Safety marks are used in this manual and the content with marks are very important, please follow them.

	Potential danger. Ignoring them may cause physical injury or death.
	Potential danger. Ignoring them may cause physical injury or hurt or damage to the devices.
	Steps for correct running.

In some situations, the content in "NOTE" is very important.

### 2.2 Reader group

Elevator controlling engineer

Maintenance personnel

Technical support engineer

	<ul style="list-style-type: none"> <li>◆ The diagrams in this manual are just examples and may be different from the products you ordered.</li> <li>◆ For the convenient application, the content of this manual will update and change as the improvement and updating of the product.</li> <li>◆ Please contact with our company as the way on the covers if needed.</li> <li>◆ The content of this manual is confirmed correct when printing, but our company reserves the right of updating.</li> </ul>
---	---

### 2.3 Warning marks

	Danger
	Please maintain the machine after the power supply is disconnected for at least 10 minutes.

The marks are presented on the front cover of the inverter.

Follow the instructions of this manual when using EC160 elevator intelligent integrated machine.

## 2.4 Safety precautions

### 2.4.1 Unpacking inspection



- ◆ Do not install or work on any damaged or faulty parts, otherwise injury may occur.

Upon unpacking, confirm the following:

1. No damage occurred during transportation (the damage or scratch to the machine).
2. The rated values on the inverter name plate are in accordance with your order.
3. The optional parts are in accordance with your order. If you find anything wrong, please contact us or the distributor.

### 2.4.2 Disassembly and assembly



- ◆ Please install according to the mechanical and electrical installation standards.
- ◆ Only experienced professionals can do the installation.
- ◆ Read the manual and safety precautions before operation.



- ◆ Do not move the machine by lifting its base, otherwise it may fall and get damaged.
- ◆ Mount the device on nonflammable material and keep away from any explosives and inflammable items, or fire and explosion may occur.
- ◆ The installation position should be free of dripping water or other liquids, or damage may occur.
- ◆ The installation platform should be strong enough to sustain the controller, or the device dropping, physical injury and damage to the controller may occur.
- ◆ Please install fans or other cooling devices to ensure the temperature in the cabinet is below 45°C when installing cooling fan or braking resistor in a cabinet, or fire and other accidents may occur.
- ◆ Make sure no conductive objects such as metal can fall into the controller, or fire and damage to the controller may occur.

### 2.4.3 Connection precautions



- ◆ Ensure the power supply is disconnected before connection, otherwise electric shock and fire may occur.
- ◆ Only professional electricians are allowed to do the connection, otherwise electric shock and fire may occur.
- ◆ Ground the PE terminal with proper techniques, otherwise electric



	<p>shock and fire may occur.</p> <ul style="list-style-type: none"> <li>◆ Ensure the action is right after safe connection, otherwise physical injury may occur.</li> <li>◆ Do not touch the conductor parts of output terminals directly, connect the output wires with the casing or short circuit the output wires, otherwise the electric shock, short circuit or fire may occur.</li> <li>◆ Do not touch the board circuit with hands directly, otherwise damage to the components may occur.</li> </ul>
	<ul style="list-style-type: none"> <li>◆ Ensure the voltage of AC main circuit is in accordance with the rated voltage of the intelligent integrated machine, otherwise electric shock, damage to the controller and fire may occur.</li> <li>◆ Do not carry out any voltage-withstand test on the controller, otherwise damage to the semi-conductors may occur.</li> <li>◆ Connect the braking resistor according to the wiring diagram, otherwise fire may occur.</li> <li>◆ Tighten the screws according to the designated moment, otherwise fire may occur.</li> <li>◆ Only professional technicians are allowed to do the design, installation, debugging and operation on the device. Follow the designated warnings, otherwise serious physical injury or property damage may occur.</li> <li>◆ The input power lines should be tightened permanently and the device needs to be grounded with proper techniques.</li> <li>◆ Dangerous voltage is still present on the following terminals even if the intelligent integrated machine does not work; power supply terminals R, S and T connect to motor terminals U, V and W.</li> <li>◆ Wait at least 10 minutes after disconnecting the power supply until the machine is discharged.</li> </ul>

#### 2.4.4 Running precautions



	<ul style="list-style-type: none"> <li>◆ Switch on the power supply after confirming the installation of terminal covers and do not remove the cover in connection, otherwise electric shock may occur.</li> <li>◆ Reset the fault after confirming the signal is disconnected, otherwise physical injury may occur.</li> <li>◆ Do not perform any signal inspection and wrong operation in running,</li> </ul>
---	---

	<p>otherwise physical injury or damage to the machine may occur.</p>
	<ul style="list-style-type: none"> <li>◆ Cooling fins will become hot. Do not touch to avoid physical hurt.</li> <li>◆ Do not touch the braking resistor, otherwise physical hurt and electric shock may occur.</li> <li>◆ EC160 elevator intelligent integrated machine is set well in factory. Do not refit by yourself, especially in running, otherwise damage to the machine may occur.</li> </ul>

**2.4.5 Maintenance and inspection precautions**

	<ul style="list-style-type: none"> <li>◆ There is high voltage terminal in the machine. Do not touch the terminal, otherwise electric shock may occur.</li> <li>◆ Do install the protective cover before powering on. Disconnect the breaker of the power circuit before removing the cover, otherwise electric shock may occur.</li> <li>◆ Do not remove the protective cover or touch the terminal before disconnecting the main circuit power. Carry out maintenance or inspection after confirming that the bus is discharged, otherwise the voltage may be present and electric shock may occur.</li> <li>◆ Only qualified electrician is allowed to maintain, check and replace the parts, otherwise electric shock and damage to the machine may occur.</li> <li>◆ Please take off the metal accessories (such as watches and rings) in working, wear insulating clothes and use the insulating tools, otherwise electric shock may occur.</li> <li>◆ Do not change or remove the terminals or connectors when powering on, otherwise electric shock may occur.</li> </ul>
	<ul style="list-style-type: none"> <li>◆ Please operate with cautions on the control board because there is integrate circuit.</li> <li>◆ Touching the PCB boards by hands directly may cause damage to the boards because of static electricity.</li> </ul>

**2.4.6 Other precautions**

	<ul style="list-style-type: none"> <li>◆ Do not refit the EC160 elevator intelligent integrated machine by yourself, or electric shock, physical injury and damage to the machine may occur.</li> </ul>
	<ul style="list-style-type: none"> <li>◆ When the life cycle ends, the product should enter the recycling system. Dispose of it separately at an appropriate collection point instead of placing it in the normal waste stream.</li> </ul>

## Chapter 3 Product overview

This chapter introduces the model, specification and performance of EC160 elevator intelligent integrated machine, as well as the delivery and installation.

### 3.1 Model description

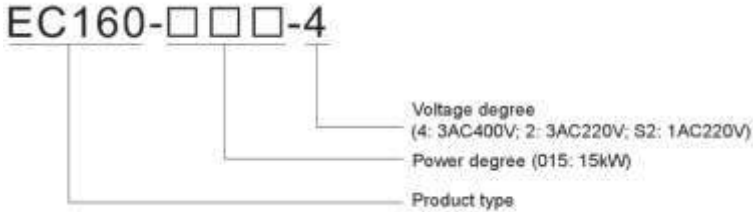

### 3.2 Name plate

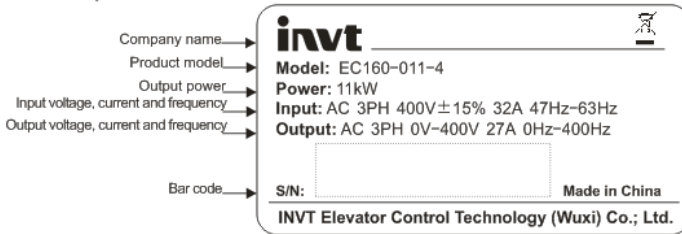

### 3.3 Power selection

Model	Rated output power (kW)	Rated output current (A)	Braking unit	Min. braking resistance
EC160-1R5-S2	1.5	5.5	Built-in	30Ω/400W
EC160-2R2-S2	2.2	11.0	Built-in	21Ω/1000W
EC160-004-2	4.0	18.5	Built-in	35Ω/1200W
EC160-5R5-2	5.5	27.0	Built-in	25Ω/1500W
EC160-7R5-2	7.5	34.0	Built-in	20Ω/2000W
EC160-011-2	11.0	46.0	Built-in	15Ω/4000W
EC160-015-2	15.0	62.0	Built-in	10Ω/4500W
EC160-018-2	18.5	75.0	DBU-055-4	8Ω/5000W
EC160-004-4	4.0	11.0	Built-in	80Ω/1200W
EC160-5R5-4	5.5	13.0	Built-in	55Ω/1500W
EC160-7R5-4	7.5	18.5	Built-in	50Ω/2000W

Model	Rated output power (kW)	Rated output current (A)	Braking unit	Min. braking resistance
EC160-011-4	11.0	27.0	Built-in	40Ω/4000W
EC160-015-4	15.0	34.0	Built-in	32Ω/4500W
EC160-018-4	18.5	38.0	Built-in	28Ω/5000W
EC160-022-4	22.0	46.0	Built-in	22Ω/7000W
EC160-030-4	30.0	62.0	Built-in	20Ω/10000W
EC160-037-4	37.0	75.0	DBU-055-4	14Ω/11100W
EC160-045-4	45.0	92.0	DBU-055-4	11Ω/13500W
EC160-055-4	55.0	115.0	DBU-055-4	9Ω/16500W

	<ul style="list-style-type: none"> <li>◆ EC160-1R5-S2 and EC160-2R2-S2 are single phase 220V input suitable for villa elevators. The external C3 filter meets CE standards.</li> <li>◆ The other power degree products are non-standard products. Please contact with our company directly if need.</li> </ul>
---	--

### 3.4 Technical specifications

Item	Name	Specification
Input/output	Input voltage	AC 400V±15%
	Input frequency	47~63Hz
	Output voltage	0~rated input voltage
	Output frequency	0~400Hz
Elevator	Highest floor	36 <sup>th</sup>
	Max. running speed	3m/s
	Group control quantity	8
	Communication mode	2 sets of CANbus communication terminal/2 sets of Modbus communication terminal
Peripheral interface	Digital low voltage input port	24 digital low voltage input terminals, DC 24V/4.5~8mA
	High voltage inspection input	3 high voltage inspection input terminals, AC/DC 110V



Item	Name	Specification
	port	
	Digital output port	6 digital output terminals, DC30V/5A, AC250V/5A, part of output terminals can use programmable logic control
	CAN communication interface	2 independent CAN communication terminals
	Encoder interface	Built-in SIN/COS, collector NPN output, push-pull output encoder interface, extensible Endat encoder interface
Technical feature	Control mode	PG vector control
	Overload capacity	150% of rated current: 60s 180% of rated current: 10s
	Starting torque	PG vector control: 0Hz/150%
	Speed control precision	PG vector control: $\pm 0.1\%$ of the Max. speed
	Carrier frequency	1.0kHz~16.0kHz
Function feature	Running mode	Fast speed mode, inspection mode, returning to leveling mode, leveling after opening mode and UPS mode
	Stopping mode	Stop at the distance control principles
	Starting torque compensation	Apply speed loop and position loop Smooth starting without weighing devices
	Master autotuning mode	Static and dynamic autotuning
	Hoistway autotuning mode	Record the position of floor and forced deceleration switch
	Auto-voltage adjustment	Keep the output voltage constant when the voltage of grid changes
Operation and monitoring	Operator keypad	2-digit LED, 8 lights and 2 buttons, for fault inquiry
	Manual controller	Parameters setting, upload, download and fault inquiry and manual calling
	Software of upper computer	Parameters setting, upload, download and fault inquiry, manual calling and curve monitoring

### 3.5 Delivery confirmation

No.	Items	Method
-----	-------	--------

1	The received product is in accordance with the ordered.	Confirm by the model in the name plate
2	Whether there is damage.	Check the appearance
3	Whether there is loose screws.	Check the tightening point with screwdriver
4	Open the front cover and check whether the control board is loose.	Check the tightening point with screwdriver

Please contact with us if anything is wrong.

### 3.6 Digitron displaying and operation instruction

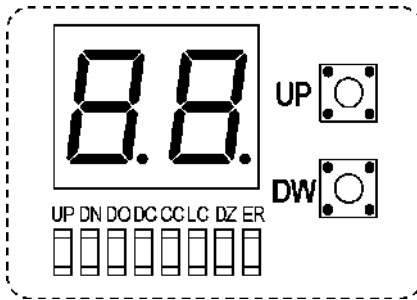

Figure 3-1 Digitron

State instructions:

No.	Code	Meaning	Instruction
1	UP	Elevator upward	Keep on when elevator upward
2	DN	Elevator downward	Keep on when elevator downward
3	DO	Door open	Flash when door is opening and keep on when the door is open
4	DC	Door closed	Flash when the door is closing and keep on when the door is closed.
5	CC	Car communication	Keep on when the communication between EC160 and car is established.
6	LC	Lock indicator	Keep on when locking
7	DZ	Door zone	Keep on when the elevator is entering into the door zone.
8	ER	Elevator error	Flash when elevator error

The LED displaying is defaulted as the current floor when there is no fault, while fault occurs, Er is

flashing and LED will report the fault code directly, such as **50** and flashing. Press UP key to watch the previous fault and the fault code will flash; press UP key to watch the next fault. Press DOWN key to reset from the fault record and enter into the floor displaying. In the maintenance state, if the elevator is in the bottom floor, dialing the maintenance switch for three times in 5 seconds will clear the fault record.

### 3.7 Running environment

#### 3.7.1 Temperature&humidity

Environment temperature range:  $-10^{\circ}\text{C}\sim+40^{\circ}\text{C}$ . Derate 4% for every additional  $1^{\circ}\text{C}$  if ambient temperature exceeds  $40^{\circ}\text{C}$ . The highest temperature is  $50^{\circ}\text{C}$ .

Humidity $\leq 90\%$  RH. No condensation is allowed.

#### 3.7.2 Altitude

The machine can output the rated power when installed with altitude of lower than 1000m. It will be derated when the altitude is higher than 1000m. For details, please refer to the following figure:

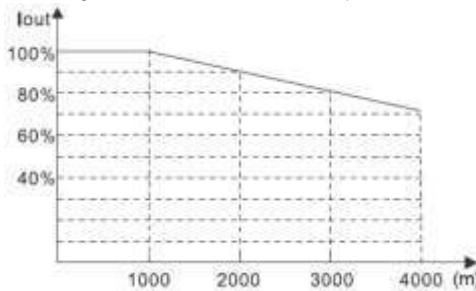

Figure 3-2 Rating curve

#### 3.7.3 Other environmental requirements

The inverter can not bear fierce impact or shock. So the oscillation range should be less than  $5.88\text{m/s}^2$  (0.6g).



The inverter should keep away from the electromagnetic radiation source.

The inverter should keep away from metal powder, dust, oil and water.

The inverter should keep away from direct sunlight, oil mist, steam and salt.

## Chapter 4 Installation and wiring

This chapter describes the terminals configuration, including main circuit terminal configuration, control circuit terminals configuration and PG terminals configuration.

	<ul style="list-style-type: none"> <li>◆ Follow the guidelines of these manual and only professional electricians are allowed to operate, otherwise electric shock may occur.</li> <li>◆ Breaker is needed between the power supply and the machine, otherwise fire may occur.</li> <li>◆ Please ensure the power supply is disconnected before wiring, otherwise the electric shock may occur.</li> <li>◆ The grounding terminal should be reliable, otherwise electric shock may occur.</li> <li>◆ Do not touch the terminals with hands, otherwise electric shock may occur.</li> <li>◆ Do not connect the power supply with U/V/W, otherwise damage may occur.</li> <li>◆ Do not connect the wires of braking resistor with the terminals (+) (-) of DC bus, otherwise electric shock and fire may occur.</li> </ul>
	<ul style="list-style-type: none"> <li>◆ Please confirm the voltage degree of the power is in accordance with that of the machine, otherwise damage may occur.</li> <li>◆ All terminals connected with the machine should be tightened enough, otherwise damage may occur.</li> <li>◆ Ensure there is no objects falling into the machine in the process of configuration and installation, otherwise damage may occur.</li> </ul>

## 4.1 Dimensions

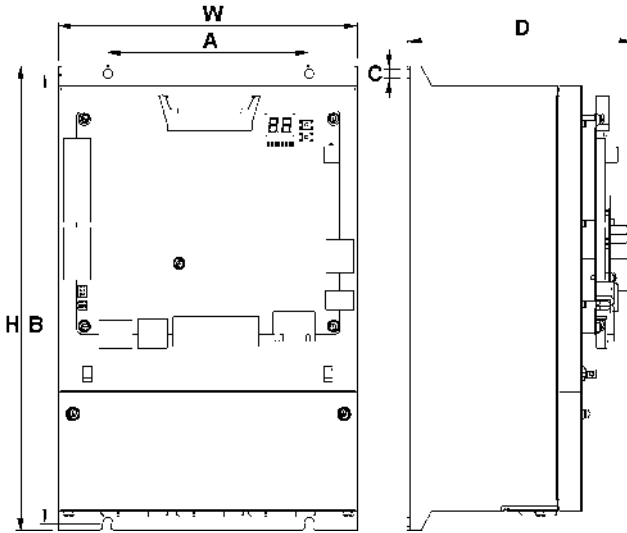



Figure 4-1 Installation dimension

Model	W (mm)	H (mm)	D (mm)	A (mm)	B (mm)	C hole size (mm)	Screw bolt
EC160-004-2	223	347	169	150	334.5	φ7	M6
EC160-5R5-2	223	347	169	150	334.5	φ7	M6
EC160-7R5-2	223	347	169	150	334.5	φ7	M6
EC160-011-2	290	426	233	235	410	φ7	M6
EC160-015-2	290	426	233	235	410	φ7	M6
EC160-004-4	223	347	168	150	334.5	φ7	M6
EC160-5R5-4	223	347	168	150	334.5	φ7	M6
EC160-7R5-4	223	347	169	150	334.5	φ7	M6
EC160-011-4	223	347	169	150	334.5	φ7	M6

EC160-015-4	223	347	169	150	334.5	φ7	M6
EC160-018-4	290	426	233	235	410	φ7	M6
EC160-022-4	290	426	233	235	410	φ7	M6
EC160-030-4	290	426	233	235	410	φ7	M6

	<p>◆ When design the control cabinet, the left and right space should be no less than 50mm and the above and below space should be no less than 100mm to ensure enough cooling.</p>
---	---

**4.1.1 Terminals instruction**

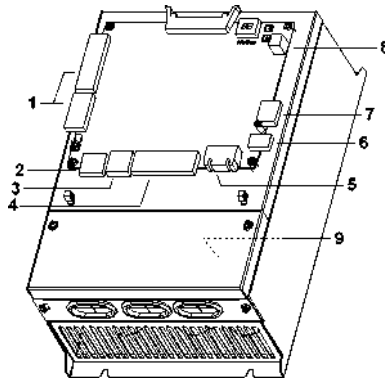

Figure 4-2 Terminals

No.	Code	Name	Remarks
1	CN3/CN4	Peripheral signal terminal	Digital input signal, analog input signal
2	CN5	Terminal for power and internal/external hall communication	DC24V input terminal, RS485 communication, CAN communication
3	CN6	High-voltage detection terminal	AC/DC110V safety, car door lock, hall door lock high-voltage detection
4	CN7	Relay output terminal	6 relay output terminals
5	CN10	Terminal for synchronous master	ERN1387 or incremental encoder with U, V and W

		encoder	
6	CN8	Terminal for parallel connection or group control communication	CAN communication
7	CN9	Terminal for asynchronous master encoder	Apply to DC12V, push-pull or open collector encoder
8	CN2	Terminal only for manual operation	Use specific cables when connecting with computer
9	CN1 (drive board)	Main circuit terminals	See 4.2.1 for the terminals arrangement.

## 4.2 Terminals of main circuit

### 4.2.1 Terminal arrangement

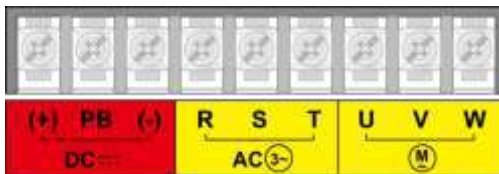

Figure 4-3 Terminals of main circuit (4kW~15kW)

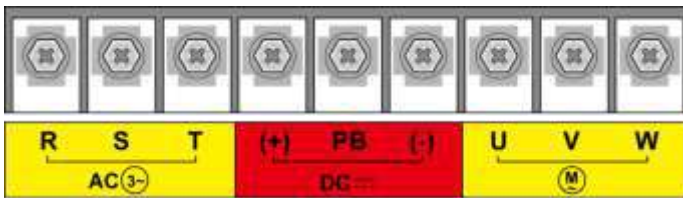



Figure 4-4 Terminals of main circuit (18.5kW~30kW)

### 4.2.2 Function instruction

Name	Function
R, S, T	3-phase power input terminals
(+), (-)	DC bus positive and negative poles
(+), PB	Wiring terminals of braking resistor
U, V, W	3-phase AC output terminals

PE, 	Grounding terminal
---	--------------------

#### 4.2.3 Specification of the main circuit leads

Model	Input leads (mm <sup>2</sup> )	Output leads (mm <sup>2</sup> )	Grounding leads (mm <sup>2</sup> )
EC160-1R5-S2	2.5	2.5	2.5
EC160-2R2-S2	4	4	4
EC160-004-2	4	4	4
EC160-5R5-2	6	6	4
EC160-7R5-2	10	10	10
EC160-011-2	16	16	16
EC160-015-2	25	25	16
EC160-018-2	25	25	16
EC160-004-4	4	4	4
EC160-5R5-4	4	4	4
EC160-7R5-4	4	4	4
EC160-011-4	6	6	4
EC160-015-4	10	10	10
EC160-018-4	16	16	16
EC160-022-4	16	16	16
EC160-030-4	25	25	16
EC160-037-4	25	25	16
EC160-045-4	35	35	16
EC160-055-4	50	50	25

#### 4.2.4 Configuration precautions

	<ul style="list-style-type: none"> <li>◆ The figures in the user manual are only examples and may be different from the products you ordered.</li> <li>◆ Connect according to the terminal grade. Shorten the length as short as possible to avoid current leakage.</li> <li>◆ Apply standard 3-phase 5-wire power supply. Ground the grounding terminals with proper techniques. It is recommended to use multiple twisted copper wires above 4mm<sup>2</sup> and ensure the grounding resistor is</li> </ul>
---	--



	<p>no more than 4Ω. Do not use the special grounding wires with other devices.</p> <ul style="list-style-type: none"> <li>◆ Do not short circuit or ground the input/output circuits.</li> <li>◆ The output terminal U/V/W of the machine needs to go through the ground metal pipe and route separately with the signal wires of the control circuit to avoid interference.</li> </ul>
--	---

#### 4.2.5 Connection of braking circuit of intelligent integrated machine in main circuit

The machine is embedded with braking unit. In order to release the regenerative energy, it is necessary to connect braking resistor in the terminal of (+) and PB.

The temperature of the braking resistor will increase as the heat-releasing. Ensure safety protection and good ventilation when installing braking resistor.

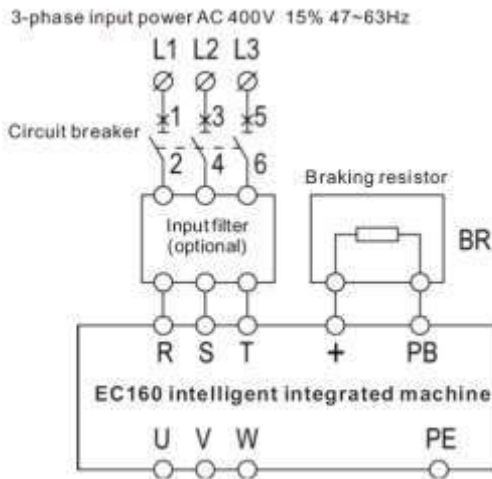

Figure 4-5 Connection diagram of braking resistor and braking unit

	<ul style="list-style-type: none"> <li>◆ (+) and (-) cannot be connected with the braking resistor directly, otherwise damage to the machine or fire may occur.</li> </ul>
--	--

#### 4.2.6 Connection of RBU series energy feedback unit

RBU series energy feedback unit can feedback the power generated from the motor to the grid.

The connection is shown as below:

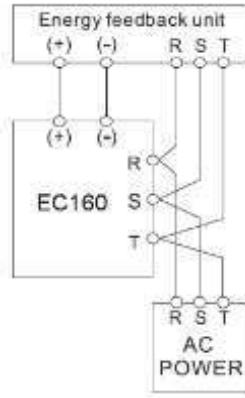

Figure 4-6 Connection diagram of energy feedback unit

#### 4.2.7 Connection of PE terminal

The PE terminal needs to be grounded with proper techniques to avoid electric shock and fire. The resistance is less than 10Ω. The grounding must be single-point to avoid a circuit.

### 4.3 Terminals of control circuit

#### 4.3.1 Definition of terminals

Plug-in No.	Pin No.	Terminal definition	Code	LED indicator code	Remarks
CN3 terminals 1-16	S1	Up door area (rear door opening detection)	SUDZ	LED4	Default NO input
	S2	Middle door area	SMDZ	LED5	Default NO input
	S3	Down door area	SDDZ	LED6	Default NO input
	S4	Contact detection of safety contactor	KASF	LED7	Default NO input
	S5	Contact detection of door lock contactor	KDL	LED8	Default NO input
	S6	Contact detection of drive output contactor	KM1	LED9	Default NC input
	S7	Contact detection of brake contactor	KBK	LED10	Default NC input

Plug-in No.	Pin No.	Terminal definition	Code	LED indicator code	Remarks
	S8	Contact detection of star-delta contactor	LINE3	LED11	Default NO input
	S9	Inspection signal (off is inspection)	INS1	LED12	Default NC input
	S10	Inspection UP button signal	UPB	LED13	Default NO input
	S11	Inspection DOWN button signal	DNB	LED14	Default NO input
	S12	Up limit switch	SUL	LED15	Default NC input
	S13	Down limit switch	SDL	LED16	Default NC input
	S14	Low speed up forced deceleration switch	SUS1	LED17	Default NC input
	S15	Low speed down forced deceleration switch	SDS1	LED18	Default NC input
	S16	Medium speed up forced deceleration switch	SUS2	LED19	Default NC input
CN4 terminals 1-10	S17	Medium speed down forced deceleration switch	SDS2	LED20	Default NC input
	S18	Motor thermal protection	SMTR	LED21	Default NO input
	S19	Intelligent integrated machine enabling	EN	LED22	Default NO input
	S20	UPS detection	KPWR	LED23	Default NO input (disabled)
	S21	Pre-opening feedback	POF	LED24	Default NO input
	S22	Spare input 1 MF input terminal	LINE1	LED25	Default NO input
	S23	Fire action input	SFR	LED26	Default NO input

Plug-in No.	Pin No.	Terminal definition	Code	LED indicator code	Remarks
	S24	Spare input 1 MF input terminal	LINE2	LED27	Default NO input
	24V-	When input low level is valid (SW3 is at 24V+), 24V- terminal is digital input common terminal.			
	24V+	When input high level is valid (SW3 is at 24V-), 24V+ terminal is digital input common terminal.			
CN5 terminals 1-6	24V	External DC24V power input	Provide 24V power for control board, digital input common terminal is selected by SW3 DIP switch:		
	COM		When SW3 is at 24V+, 24V- terminal of CN4 is digital input common terminal; when SW3 is at 24V-, 24V+ terminal of CN4 is digital input common terminal.		
	MODH	RS-485 differential signal	Standard isolated RS-485 communication interface, for hall calling and displaying. Note: By default, 485 interface is at ON and the resistance is about 120Ω.		
	MODL				
	CANH	CAN1 bus differential signal	CAN1 communication interface, connect with car top board. Note: By default, CAN interface is at ON and the resistance is about 120Ω.		
	CANL				
CN6 terminals 1-4	DC1+	High voltage detection of safety circuit	DC1+	LED28	High voltage detection terminal, input voltage range: 110VAC±15%
	DC2+	High voltage detection of car door lock	DC2+	LED29	
	DC3+	High voltage detection of hall door lock	DC3+	LED30	
	DC-	High voltage detection input common terminal	DC-		
CN7 terminals 1-12	Y1	JKM running contactor output	Y1	LED34	Relay NO output 5A, 250VAC
	COM1	Y1 common terminal	COM1		
	Y2	JKBK brake contactor	Y2	LED35	Relay NO output 5A,

Plug-in No.	Pin No.	Terminal definition	Code	LED indicator code	Remarks
		output			250VAC
	COM2	Y2 common terminal	COM2		
	Y3	Star-delta contactor output (synchronous tractor)	Y3	LED36	Relay NO output 5A, 250VAC
	COM3	Y3 common terminal	COM3		
	Y4	FR fire forced output	Y4	LED37	Relay NO output 5A, 250VAC
	COM4	Y4 common terminal	COM4		
	Y5	MF defined output 1	Y5	LED32	Relay NO output 5A, 250VAC
	COM5	Y5 common terminal	COM5		
	Y6	MF defined output 2	Y6	LED33	Relay NO output 5A, 250VAC
	COM6	Y6 common terminal	COM6		
CN8 terminals 1-3	GPRH	CAN2 bus differential signal	CAN2 communication interface, for parallel connection and group control: the default terminal resistance is about 120Ω.		
	GPRL				
	COM				
CN9 terminals 1-6	12V	Encoder power 12V			Encoder terminal of asynchronous master, supply DC12V power
	PGM	Encoder power 0V			
	PGA	Encoder input A phase			
	PGB	Encoder input B phase			
	PGM	Encoder power 0V			
	PE	Grounding terminal			
CN10	Encoder terminal of synchronous master (apply for ECN1387), see wiring diagram.				
CN11	Connecting terminal of PG card (apply for ECN1313 encoder or rotary transformer)				
CN15 1-4	AI1	Positive analog input terminal	AI1		Input impedance: 10Ω; Voltage range: 0~10V
	GND	Negative analog input terminal	GND		
	485+	RS485 differential signal	485+		For monitoring
	485-		485-		For monitoring

### 4.3.2 Specification of digital input signal

Input		Open circuit input	Optical isolation
Current signal	"0" electrical level	0~2mA	
	"1" electrical level	4.5~8mA	
Voltage signal	"0" electrical level	18~24V DC	
	"1" electrical level	0~5V DC	
Signal digital filter delay		30mS	
Signal response frequency		200Hz	

### 4.3.3 Specification of relay digital output signal

Output	Relay output
AC	250V AC
DC	110V DC
Inductive load	3 A
Resistor load	5 A
Electrical life	3 million times
Mechanical life	10 million times

## 4.4 Encoder wiring

### 4.4.1 Encoder wiring of asynchronous master

When using the asynchronous master, please use push-pull or open collector output and the encoder with the power supply including DC12V (such as DC10~30V). The interface of the encoder will be connected with CN9, which is shown as below:

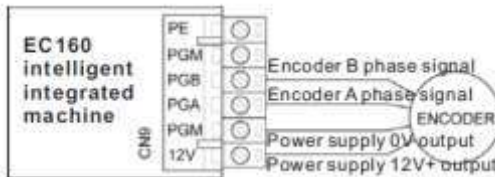

Figure 4-7 Encoder wiring diagram of asynchronous master

### 4.4.2 Encoder wiring of synchronous master

When using the synchronous master, please use the encoder of DC5V and the interface is connected with female terminal CN10\_DB15 of the intelligent integrated machine. There are two types of encoders:

- It is recommended to install the encoder, such as SIN/COS rotary encoder, for example,

HEIDENHAIN ERN1387;

- U, V and W encoder: the polarity number of the encoder should be the same with that of the motor. If using the encoder, it is necessary to install weighing compensation devices.

Besides, EC160 can extend PG card of Endat encoder via CN11 to support ECN1313 encoder.

The encoder wiring diagram of synchronous master is shown as follows:

 Db15 male connecting EC100/EC160				 1387 encoder double socket for EC100/EC160				 1313 encoder double socket for EC160 (need PG card)			
PIN	SIN/COS	UVW	ENDAT								
1	B-	B-	A+	5a	B-	2a	A+(COS+)				
2	null	null	A-	X		5b	A-(COS-)				
3	R+	Z+	B+	4b	R+(Z+)	4a	B+(SIN+)				
4	R-	Z-	B-	4a	R-(Z-)	3b	B-(SIN-)				
5	A+	A+	Data+	6b	A+	6b	Data+				
6	A-	A-	Data-	2a	A-	1a	Data-				
7	0V	0V	null	3a+5b	0V	X					
8	B+	B+	null	3b	B+						
9	5V	5V	null	7a+1b	5V						
10	C-	U-	null	1a	C-(SIN-)						
11	C+	U+	Clk+	7b	C+(SIN+)	2b	Clk+				
12	D+	V+	Clk-	2b	D+(COS+)	5a	Clk-				
13	D-	V-	5V	6a	D-(COS-)	1b	5V				
14	null	W+	0V	X		4b	0V				
15	null	W-	null	X		X					

Figure 4-8 Wiring diagram of SIN/COS and UWW encoder of synchronous master

	<ul style="list-style-type: none"> <li>◆ Please select the twisted shield pairs and the shield level can only be grounded with one side.</li> <li>◆ Avoid the power cables when configuration, and shorten the length of the cable and through the metal pipes.</li> </ul>
---	--

## 4.5 System installation and configuration

### 4.5.1 Electrical installation of hoistway

Install a leveling switch SMDZ on the top of the car (select the installation manner of double door area via F0\_24, connect up leveling switch SUDZ and down leveling switch SDDZ) and a plate with the length of 120~300mm in each floor. When the car is leveling, the plate is in the middle of the leveling switch.

For the elevators with different speed, install forced deceleration switch. Generally, install SDS1 and SUS1 for the elevator with speed less than 1.75m/s; install SDS2 and SUS2 for the elevator with speed of 2.0m/s~3.0m/s (in order to avoid shock, bitable magnetic switch is recommended). The installation position in Figure 4-5 means the distance between the car and the leveling when the switch action is valid. Install up leveling switch SUDZ and down leveling switch SDDZ on the top of the car for the elevator with releveling. The three switches are installed vertically and SMDZ is in the middle. When the car is leveling accurately, the plate is located at three leveling switches. Install a SDL and SDFL on the top floor; install a SUL and SUFL on the ground floor.

**4.5.2 Installation position of hoistway switch**

See the table below for the switch installation distance. For the switch installation manner, refer to Figure 4-10. During commissioning, adjust according to the operator.

Rated speed Forced deceleration distance	≤0.7m/s	≤1.0m/s	≤1.5m/s	≤1.75m/s	≤2.0m/s	≤2.5m/s	≤3.0m/s
L1 low speed forced deceleration distance	0.4m	0.8m	1.6m	2.2m	0.6~1.8m		
L2 medium speed forced deceleration distance	—				2.8m	4.2m	5.8m

SDS1-low speed down forced deceleration switch

SUS1-low speed up forced deceleration switch

SDS2-medium speed down forced deceleration switch



SUS2-medium speed up forced deceleration switch

SDL- Down limit switch

SUL-Up limit switch

SDFL-Down extreme switch

SUFL-Up extreme switch

	<ul style="list-style-type: none"> <li>◆ Note the plugging depth of the plate to the standard line when applying magnetic switch for SMDZ.</li> <li>◆ The NO/NC state of the leveling switch can be changed through modifying the input logic of the controller.</li> <li>◆ Do not drop conductive matters into the controller; otherwise, fire or damage to the controller may occur.</li> </ul>
	<ul style="list-style-type: none"> <li>◆ For the position of the low speed forced deceleration switch, the elevator should act at the terminal stop and not act at the non-terminal</li> </ul>



	<p>stop. After the elevator compresses the buffer according to the national standards, the switch still keeps acting.</p> <ul style="list-style-type: none"><li>◆ The table above lists the recommended position of corresponding forced deceleration switch at common speed. The specific conditions subject to commissioning are closely related to floor height of terminal stop, starting acceleration curve and effective length of anti-collision device. For example, when the anti-collision of the elevator at 1.75m/s is not long enough, change L1 to 1.2m and L2 to 2.2m; when the elevator is at 1.0m/s, the bottom floor is 0.7m high and other floors are 3m high, install 2 deceleration switches at the bottom floor: L1=0.3m, L2=0.8m and 1 0.8m deceleration switch at the top floor.</li><li>◆ If the speed of the elevator is <math>V</math> when it accelerates to the first deceleration switch by the whole target distance, the distance between the switch and terminal stop leveling line <math>L=0.61 \times V^2 + 0.2 \times V</math>.</li></ul>
--	---

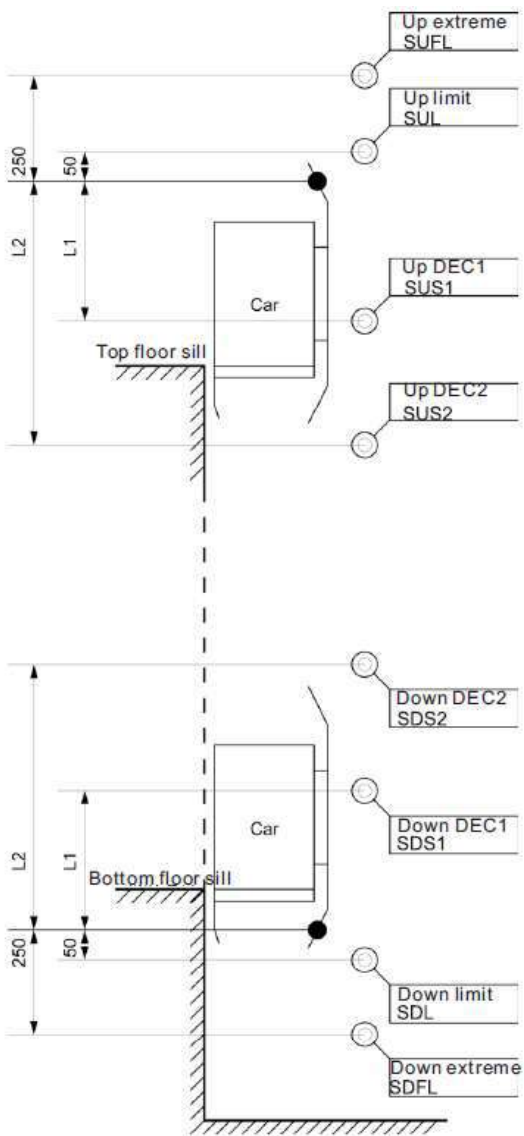

Figure 4-9 Installation position of hoistway switch

### **4.5.3 Connection precautions of peripheral devices**

#### **4.5.3.1 Power supply**

The voltage of the power supply corresponds to the rated voltage of the machine, the fluctuation range <7%.

#### **4.5.3.2 Breaker**

The breaker is needed between the power supply and the input terminals of the integrated machine.

The capacity of the breaker is 1.5~2 times of the rated current of the intelligent integrated machine.

#### **4.5.3.3 AC reactor at the input side**

Improve the power factor of the power supply and reduce the harmonic current.

#### **4.5.3.4 Filter at the input side**

Suppress the interference caused by high-frequency noise.

#### **4.5.3.5 Output contactor in main circuit**

Control the current of the tractor. The contactor will close when the elevator starts and release when the elevator stops. It is recommended to refer to the electrical diagram of our company to install two contactors between the drive device and the tractor.

#### **4.5.3.6 Filter at the output side**

Suppress the noise interference and the leakage current.

#### **4.5.3.7 AC reactor at the output side**

Suppress the radio frequency interference.

### **4.5.4 CAN and 485 communication configuration**

There are 4 cables for communication in the hoistway and the trailing cable. The calling communication is 24V+, 24V-, MODH and MODL and the car communication is 24V+, 24V-, CANL and CANH.



In order to avoid short circuit, measure with multimeter to ensure if circuit is present between the 4 cables and others before power on, especially the power cable of 24V, 36V, 110V, 220V, 380V. 24V power supply is provided to the branch. The diameter is equal to or more than  $0.75\text{mm}^2$ . In higher floor (higher than 25<sup>th</sup> floor), reduce the voltage drop and ensure the farthest external power voltage is more than 20V.

Twisted-pair specifications: characteristic impedance 120Ω; allowable range 108~132Ω

Stranding pitch: ≤30mm      Diameter: ≥ $0.75\text{mm}^2$

If the parallel distance between the communication and power cables is longer than 5m, there should be a 30cm space to prevent power interference. If the wiring space is limited and cannot satisfy the requirements, use the shielded twisted pair and carry out single-point grounding.

Grounding of the hoistway cable and the trailing cable: separate the electric wires (including door operator power, safety circuit, door lock circuit and lighting circuit, etc.) from the electronic wires (including communication cables, DC 0V, DC 24V, leveling dry-reed, forced deceleration switches of terminal stop, limit switches of terminal stop, etc.) for hoistway cable and the trailing cable. The communication cables must use twisted cables with the distance less than 30mm. If possible, use the shielded twisted pair and ground the shielded layer.

	<ul style="list-style-type: none"> <li>◆ If the electric wires and electronic wires are configured in parallel, put the electric wires together on one side and the electronic wires together on the other side. Use the grounding wires to separate them.</li> </ul>
	<ul style="list-style-type: none"> <li>◆ Do not plug RS-485 and CAN communication plug (24V+, 24V-, MODH and MODL; 24V+, 24V-, CANH and CANL) when power on, otherwise permanent damage to the components may occur.</li> <li>◆ Abnormal communication may occur if setting RS-485 and CAN terminal resistor improperly.</li> <li>◆ In general, the resistance between MODH and MODL, CANH and CANL is about 60Ω.</li> </ul>
	<ul style="list-style-type: none"> <li>◆ RS-485 and CAN communication cable shall be twisted pairs and the twisted distance is less than 30mm.</li> <li>◆ RS-485 and CAN bus communication cable shall keep away from electric wires; the communication power cable, communication cable and electric wire can not be twisted.</li> <li>◆ RS-485 and CAN communication cable can not connect with other circuit or grounding wire.</li> <li>◆ The specific RS-485 and CAN communication power cable shall be separated from 24V power of the controller and cannot be used for other purposes or connect with other loads.</li> <li>◆ The outside/inside calling board is collector open-drain output and only applied for loads such as LEDs but not for lamps. If the elevator is made from old ones, change the button.</li> <li>◆ Refer to the electrical diagram for detailed configuration.</li> </ul>

## 4.6 Installation guideline to EMC compliance

### 4.6.1 General knowledge of EMC

EMC is the abbreviation of electromagnetic compatibility, which means the device or system has the ability to work normally in the electromagnetic environment and will not generate any electromagnetic interference to other equipments. EMC includes two subjects: electromagnetic interference and electromagnetic anti-jamming.

According to the transmission mode, electromagnetic interference can be divided into two categories: conducted interference and radiated interference.

Conducted interference is the interference transmitted by conductor. Therefore, any conductors (such as wire, transmission line, inductor, capacitor and so on) are the transmission channels of the interference.

Radiated interference is the interference transmitted in electromagnetic wave, and the energy is inversely proportional to the square of distance.

Three necessary conditions or essentials of electromagnetic interference are: interference source, transmission channel and sensitive receiver. For customers, the solution of EMC problem is mainly in transmission channel because of the device attribute of disturbance source and receiver can not be changed.

Because different electric and electronic devices vary in EMC standards or degrees, the EMC ability is also different.

### 4.6.2 EMC features of inverter

Like other electric or electronic devices, inverter is not only an electromagnetic interference source but also an electromagnetic receiver. The operating principle of inverter determines that it can produce certain electromagnetic interference noise. And the same time inverter should be designed with certain anti-jamming ability to ensure the smooth working in certain electromagnetic environment. The following is its EMC features:

- Input current is non-sine wave. The input current includes large amount of high-harmonic waves that can cause electromagnetic interference, decrease the grid power factor and increase the line loss.
- Output voltage is high frequency PWM wave, which can increase the temperature rise and shorten the life of motor. And the leakage current will also increase, which can lead to the leakage protection device malfunction and generate strong electromagnetic interference to influence the reliability of other electric devices.
- As the electromagnetic receiver, too strong interference will damage the inverter and influence the normal using of customers.

- In the system, EMS and EMI of inverter coexist. Decrease the EMI of inverter can increase its EMS ability.

### **4.6.3 EMC installation guideline**

In order to ensure all electric devices in the same system to work smoothly, this section, based on EMC features of inverter, introduces EMC installation process in several aspects of application (noise control, site wiring, grounding, leakage current and power supply filter). The good effect of EMC will depend on the good effect of all of these five aspects.

#### **4.6.3.1 Noise control**

All the connections to the control terminals must use shielded wire. And the shield layer of the wire must ground near the wire entrance of inverter. The ground mode is 360 degree annular connection formed by cable clips. It is strictly prohibitive to connect the twisted shielding layer to the ground of inverter, which greatly decreases or loses the shielding effect.

Connect inverter and motor with the shielded wire or the separated cable tray. One side of shield layer of shielded wire or metal cover of separated cable tray should connect to ground, and the other side should connect to the motor cover. Installing an EMC filter can reduce the electromagnetic noise greatly.

#### **4.6.3.2 Site wiring**

Power supply wiring: the power should be separated supplied from electrical transformer. Normally it is 5 core wires, three of which are fire wires, one of which is the neutral wire, and one of which is the ground wire. It is strictly prohibitive to use the same line to be both the neutral wire and the ground wire.

Device categorization: there are different electric devices contained in one control cabinet, such as inverter, filter and instrument etc, which have different ability of emitting and withstanding electromagnetic noise. Therefore, it needs to categorize these devices into strong noise device and noise sensitive device. The same kind of device should be placed in the same area, and the distance between devices of different category should be more than 20cm.

Wire arrangement inside the control cabinet: there are signal wire (weak current) and power cable (strong current) in one cabinet. For the inverter, the power cables are categorized into input cable and output cable. Signal wires can be easily disturbed by power cables to make the equipment malfunction. Therefore when wiring, signal cables and power cables should be arranged in different area. It is strictly prohibitive to arrange them in parallel or interlacement at a close distance (less than 20cm) or tie them together. If the signal wires have to cross the power cables, they should be arranged in 90 angles. Power input and output cables should not be arranged in interlacement or tied together, especially when installed the EMC filter. Otherwise the distributed capacitances of its input

and output power cable can be coupling each other to make the EMC filter out of function.

#### **4.6.3.3 Grounding**

Inverter must be grounded safely when in operation. Grounding enjoys priority in all EMC methods because it does not only ensure the safety of equipment and persons, but also is the simplest, most effective and lowest cost solution to EMC problems.

Grounding has three categories: special pole grounding, common pole grounding and series grounding. Different control system should use special pole grounding, and different devices in the same control system should use common pole grounding, and different devices connected by same power cable should use series grounding.

#### **4.6.3.4 Leakage current**

Leakage current includes line-to-line leakage current and over-ground leakage current. Its value depends on distributed capacitances and carrier frequency of inverter. The over-ground leakage current, which is the current passing through the common ground wire, can not only flow into inverter system but also other devices. It also can make leakage current circuit breaker, relay or other devices malfunction. The value of line-to-line leakage current, which means the leakage current passing through distributed capacitors of input output wire, depends on the carrier frequency of inverter, the length and section areas of motor cables. The higher carrier frequency of inverter, the longer of the motor cable and/or the bigger cable section area, the larger leakage current will occur.

#### **Countermeasure:**

Decreasing the carrier frequency can effectively decrease the leakage current. In the case of motor cable is relatively long (longer than 50m), it is necessary to install AC reactor or sinusoidal wave filter at the output side, and when it is even longer, it is necessary to install one reactor at every certain distance.

#### **4.6.3.5 EMC filter**

EMC filter has a great effect of electromagnetic decoupling, so it is preferred for customer to install it. For inverter, noise filter has following categories:

- Noise filter installed at the input side of inverter;
- Install noise isolation for other equipment by means of isolation transformer or power filter.

#### **4.6.4 Installation specification**

If user install inverter and EMI filter according to the installation guideline, we believe inverter system comply with following compliance.

EN61000-6-4; EN61000-6-3; EN61800-3

## Chapter 5 Debugging tools

### 5.1 Instruction

Manual controller is the specific debugging tools for system debugging and maintenance. It consists of LCD display and keys which has following functions:

#### 5.1.1 Main controlling interface

Following elevator state can be watched through LCD displaying:

- The automotive, maintenance, attendant, fire safety, overload and door open state;
- Inside and outside calling signal of the elevator;
- Floor position of the elevator;
- Running direction of the elevator.

#### 5.1.2 Fault record

Inquiry the fault time, floor, input/output state.

#### 5.1.3 Parameters setting

Set all the elevator parameters through the manual controller

- Speed setting;
- Motor parameters setting;
- Encoder parameters setting;
- Floor parameters setting;
- Comfortability and protective parameters setting;
- Time and function parameters setting

#### 5.1.4 Password setting

The password of the loading page can be modified and the current password can be used to modify the current password and the lower grade password.

#### 5.1.5 System autotuning

Relative elevator autotuning:

- Hoistway autotuning of the elevator;
- Static autotuning of the motor;
- Rotating autotuning of the motor;
- Weighing autotuning.

#### 5.1.6 Data management

- Data storage;



- Factory setting restore;
- Fault history clearance.

## 5.2 Connection method

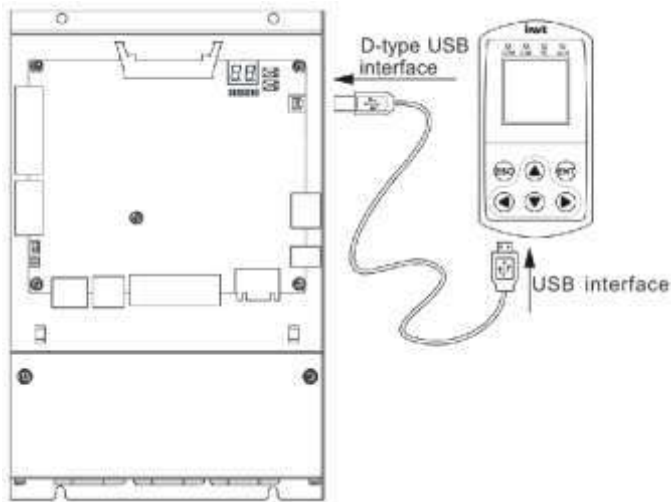
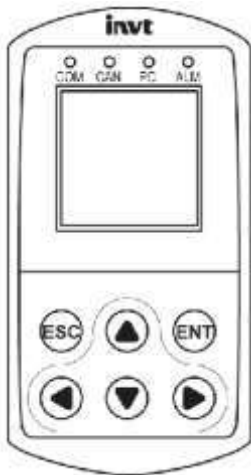

Figure 5-1 Interface of the manual controller and EC160

## 5.3 Keys and LED indicator

### 5.3.1 Key definition



No.	Key	Instruction
1		Escape key, return to the previous menu
2		Increase data or function code progressively
3		Decrease data or function code progressively
4		Move left to select the parameter
5		Move right to select the parameter
6		Enter the next menu or confirm the current operation

Figure 5-2 Appearance and key definition

5.3.2 Manual controller and LED indicator

No.	Code	Meaning	Instruction
1	COM	Connection signal of manual controller and EC160	On when normal communication
2	CAN	Connection signal of manual controller and the car	On when normal communication
3	PC	Connection signal of manual controller and the computer	On when normal communication
4	ALM	Connection fault	Flash when no communication

5.4 Operation procedure flowchart

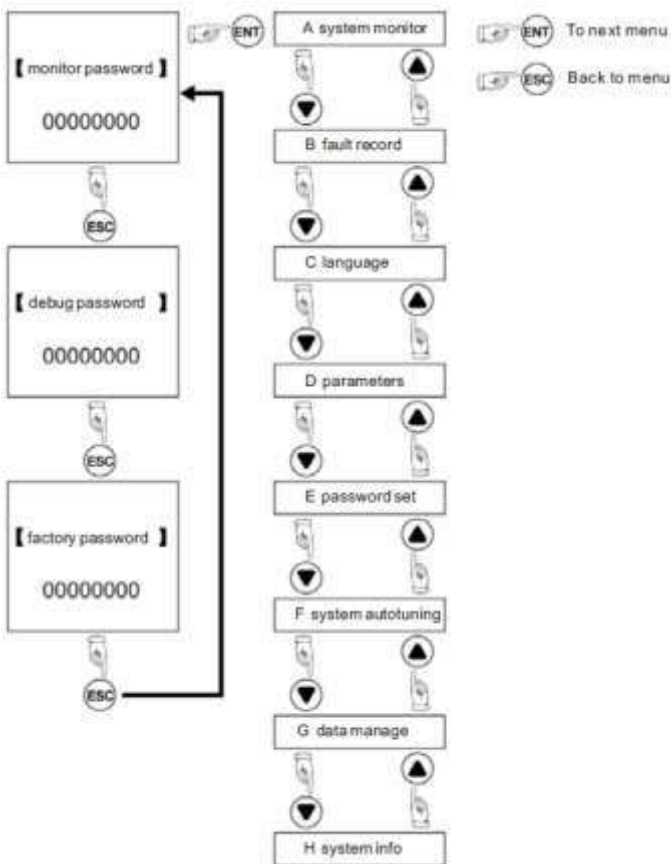

Figure 5-3 Operation procedure flowchart

## 5.5 Simple manual controller

### 5.5.1 Introduction

The simple manual controller (hereafter referred to as controller) consists of 5-figure LED, 7 LED indicators and 8 keys. As the simple debugging tool for EC160, the controller has the basic functions of parameter setting, fault inquiry, running monitoring, factory authorization and manual calling. The figure is shown below:

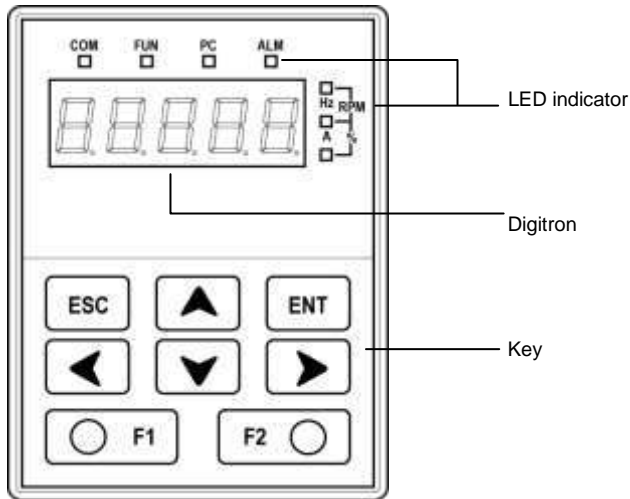

Figure 5-4 Simple manual controller

### 5.5.2 Key instruction

No.	Code	Description
1	ESC	Return to the previous menu or shift between monitoring and menu
2	ENT	Enter the next menu or set parameters and password
3	▲	Increase data or function code progressively or browse read-only parameters one by one
4	▼	Decrease data or function code progressively or browse read-only parameters one by one
5	◀	In the interface of setting parameters or password, move left to select data or function code
6	▶	In the interface of setting parameters or password, move right to select data or function code
7	F1	In the interface of password input, enter the parameter read-only inquiry state

8	F2	After inputting correct password, enter the quick debugging parameters interface
9	▲+▼	Power on after pressing the UP and DOWN key at the same time and then enter the authorization and inquiry mode of the upper computer.

**5.5.3 LED indicator instruction**

No.	Code	Description
1	COM	On when communication between controller and EC160 is normal
2	FUN	On when the setting or monitoring parameter is speed
3	PC	On when communication between controller and computer is normal
4	ALM	On when no communication for the controller
5	Hz	On when the setting or monitoring parameter is frequency
6	A	On when the setting or monitoring parameter is current
7	V	On when the setting or monitoring parameter is voltage
8	Hz+A	On when the setting or monitoring parameter is rotating speed
9	A+V	On when the setting or monitoring parameter is percentage

**5.5.4 Comparison table of digitron word**

Displayed word	0	1	2	3	4	5
Corresponding word	0	1	2	3	4	5
Displayed word	6	7	8	9	A	b
Corresponding word	6	7	8	9	A	b
Displayed word	C	d	E	F	H	L
Corresponding word	C	d	E	F	H	L
Displayed word	N	o	P	r	t	U
Corresponding word	N	o	P	r	t	U
Displayed word	AL	No	Er	FL	non	

Corresponding word	AL total number	No serial number	Er fault code	FL floor	NON no fault record
Displayed word	SEC		StENd		StErr
Corresponding word	SEC fault time second		StENd weighing autotuning succeeded		StErr weighing autotuning failed

## 5.5.5 Operation procedure flowchart

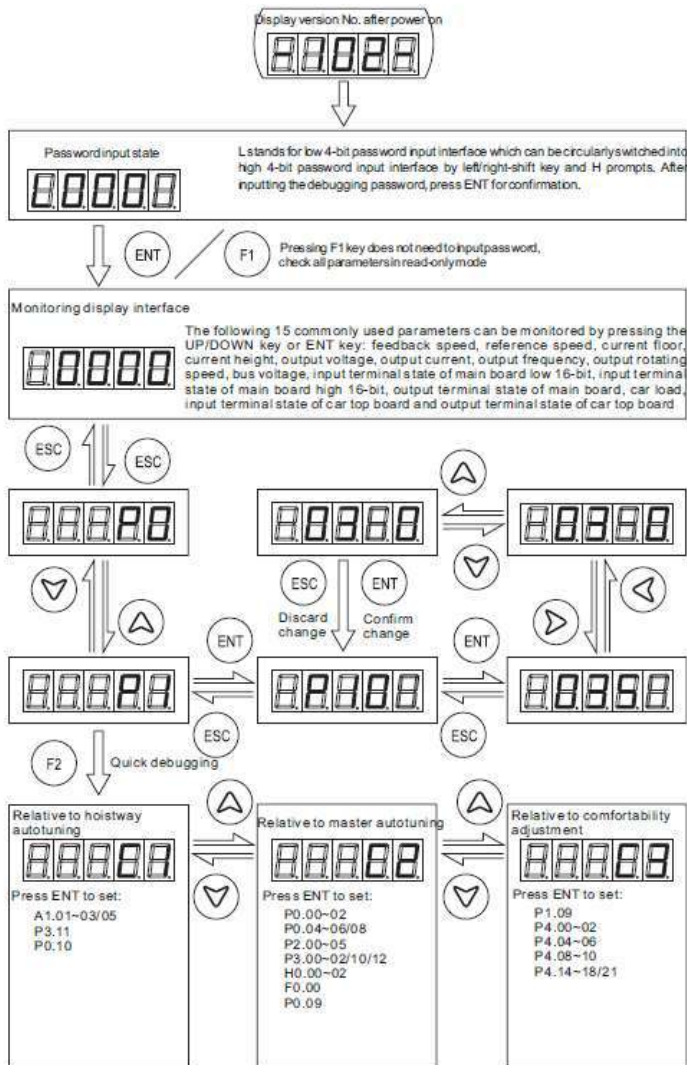
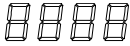

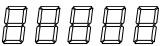

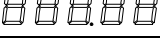
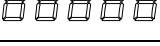
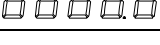
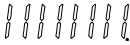
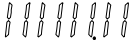



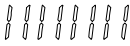

Figure 5-5 Operation procedure flowchart of simple manual controller

## 5.5.6 Monitoring instruction

No.	Name	Display format	Detailed description
1	Feedback speed	8888	Unit: mm/s, FUN LED on

2	Reference speed		Unit: mm/s, FUN LED on																
3	Current floor		Floor number																
4	Current height		Unit: m																
5	Output voltage		Unit: V, V LED on																
6	Output current		Unit: A, A LED on																
7	Output frequency		Unit: Hz, Hz LED on																
8	Output rotating speed		Unit: rpm, A and Hz LED on																
9	Bus voltage		Unit: V, V LED on																
10	Input terminal state of main board low 16-bit		SUL	SDL	SUS3	SDS3	SUS2	SDS2	SUS1	SDS1	KSAF	SMDZ	SDDZ	SUDZ	DNB	UPB	INS2	INS1	SDS1
			A22	KPWR	SFR	SMTR	SBR	KBK	KM1	KDL	LIN3	LIN2	LIN1	POC	POF	DEN	A220	A30	
11	Input terminal state of main board high 16-bit		LIN3	LIN2	LIN1	POC	POF	DEN	A220	A30	N/A	N/A	N/A	1FR	N/A	KBK1	JKM2	JKM1	
			N/A	N/A	N/A	N/A	Y6	Y5	N/A	N/A									
12	Output terminal state of main board		N/A	N/A	N/A	1FR	N/A	KBK1	JKM2	JKM1	N/A	N/A	N/A	N/A	Y6	Y5	N/A	N/A	
			N/A	N/A	N/A	N/A	Y6	Y5	N/A	N/A									
13	Car load		Need to add the analog weighing device																
14	Input terminal state of car top board		SE	CB	OB	DCL	DOL	OL	PAS	ATT	FRCL	RDCL	RDOL	IND	DS	RSE	FL	LL	
			DODL	PASL	DO	DC	BK2	BK1	KLS	CHM	N/A	N/A	N/A	CHML	RDO	RDC	OBL	CBL	
15	Output terminal state of car top board		N/A	N/A	N/A	CHML	RDO	RDC	OBL	CBL	DODL	PASL	DO	DC	BK2	BK1	KLS	CHM	

## 5.5.7 Corresponding list of function parameters

Function code	Name	Detailed instruction of parameters	Default value
P0 Group Master drive control			
P0.00	Speed control mode	0: Vector control without PG 1: Vector control with PG 2: V/F control	1
P0.01	Rated speed of the elevator	0.100~6.000m/s	1.750
P0.02	Max. speed of the elevator	0.100~P0.01m/s	1.750
P0.03	Max. output frequency	10.00~400.00Hz	27.80
P0.04	Diameter of traction sheave	100~2000mm	400
P0.05	Reduction ratio	1.00~100.00	1.00
P0.06	Suspension ratio of traction rope	1~8	2
P0.07	Carrier frequency	1.0~16.0kHz	6.0
P0.08	Running direction selection	0: Default direction 1: Reverse direction	0
P0.09	Motor parameters autotuning	0: No operation 1: Rotating autotuning 2: Static autotuning	0
P0.10	Hoistway autotuning	0: No operation 1: Hoistway autotuning	0
P0.11	Car weighing autotuning	0: No operation 1: Light load autotuning 2: Full load autotuning 3: Overload autotuning	0
P0.12	Data management operation	0: No operation 1: Data storage after power loss 2: Factory setting restore 3: Fault record clearance	0
P0.13	Reserved	0~2	0



Function code	Name	Detailed instruction of parameters	Default value
P0.14	Reserved	0~65535	0
P0.15	Reserved	0~65535	0
<b>P1 Group Speed curve adjustment</b>			
P1.00	Increasing acceleration 1	0.001~1.000m/s <sup>3</sup>	0.350
P1.01	Increasing acceleration 2	0.001~10.000m/s <sup>3</sup>	0.350
P1.02	Acceleration speed	0.001~1.000m/s <sup>2</sup>	0.700
P1.03	Reducing deceleration 1	0.001~10.000m/s <sup>3</sup>	0.350
P1.04	Reducing deceleration 2	0.001~10.000m/s <sup>3</sup>	0.350
P1.05	Deceleration speed	0.001~1.000m/s <sup>2</sup>	0.700
P1.06	Door area	0~1000mm	200
P1.07	Zero-speed threshold	0~0.050m/s	0.000
P1.08	Pre-opening speed threshold	0~0.200m/s	0.050
P1.09	Inspection speed	0~0.630m/s	0.200
P1.10	Peristaltic landing speed	0~0.200m/s	0.030
P1.11	UPS running speed	0~1.000m/s	0.100
P1.12	Landing speed	0~1.000m/s	0.200
P1.13	Autotuning speed	0~1.000m/s	0.100
P1.14	Landing precision	0~100mm	50
P1.15	Reserved	0~65535	0
P1.16	High-speed current loop proportional coefficient	0~65535	0
P1.17	High-speed current loop integral time	0~65535	0
<b>P2 Group Motor parameters</b>			
P2.00	Motor type selection	0: Asynchronous master 1: Synchronous master	1
P2.01	Rated power of the motor	0.1~150.0kW	Depend on model

Function code	Name	Detailed instruction of parameters	Default value
P2.02	Rated frequency of the motor	3.00Hz~400.00	50.00
P2.03	Rated speed of the motor	1~30000rpm	1440
P2.04	Rated voltage of the motor	0~460V	380
P2.05	Rated current of the motor	0.1~1000.0A	Depend on model
P2.06	Stator resistance of the motor	0.001~65.535Ω	Depend on model
P2.07	Rotor resistance of the motor	0.001~65.535Ω	Depend on model
P2.08	Inductance of the motor	0.1~6553.5mH	Depend on model
P2.09	Mutual inductance of the motor	0.1~6553.5mH	Depend on model
P2.10	Non-load current of the motor	0.01~655.35A	Depend on model
P2.11	Reserved	0~65535	0
P2.12	Reserved	0~65535	0
<b>P3 Group Encoder parameters</b>			
P3.00	Encoder type selection	0: Incremental encoder 1: SIN/COS encoder 2: UVW encoder 3: ENDAT encoder	1
P3.01	Encoder resolution	1~10000	2048
P3.02	Encoder direction	0: Forward input 1: Reverse input	0
P3.03	Disconnection detection time of the encoder at low speed	0.1~10.0s 0.0: No detection	1.0

Function code	Name	Detailed instruction of parameters	Default value
P3.04	Disconnection detection time of the encoder at high speed	0.1~10.0s 0.0: No detection	1.0
P3.05	Reverse detection time of the encoder	0.1~10.0s 0.0: No detection	1.0
P3.06	Magnetic pole position amplitude gain	0.50~1.50	1.00
P3.07	Magnetic pole bias of C phase	0~9999	395
P3.08	Magnetic pole bias of D phase	0~9999	395
P3.09	Initial position of the magnetic pole	0.00~360.00	0.00
P3.10	Static identification current	10.0%~150.0%	50.0
P3.11	Pulse counting direction	0~7 0: Do not change 2: Reverse for the synchronous motor 4: Reverse for the asynchronous motor	0
P3.12	CD phase line of 1387 encoder	0~65535 0: CD phase forward detection 1: CD phase reverse detection	0
<b>P4 Group Running comfortability</b>			
P4.00	ASR low speed proportional gain	0~100	20
P4.01	ASR low speed integral time	0.01~10.00s	0.5
P4.02	Speed detection low speed filter times	0~8	0
P4.03	Switch low point frequency	0.00Hz~P4.07	2.00

Function code	Name	Detailed instruction of parameters	Default value
P4.04	ASR high speed proportional gain	0~100	20
P4.05	ASR high speed integral time	0.01~10.00s	0.60
P4.06	Speed detection high speed filter times	0~8	0
P4.07	Switch high point frequency	P4.03~P0.03	5.00
P4.08	ACR proportional coefficient P	0~65535	2000
P4.09	ACR integral coefficient I	0~65535	1000
P4.10	ACR filter coefficient	0~65535	1
P4.11	Slip compensation rate of drive side	50~200%	100
P4.12	Slip compensation rate of braking side	50~200%	100
P4.13	Torque upper limit	0.0~200.0%	150.0
P4.14	Load compensation action	0: No action 1: Action	1
P4.15	Load compensation time	0.000~5.000s	0.700
P4.16	Reducing time of load compensation	0.000~5.000s	0.300
P4.17	Load compensation proportional gain	0~100	30
P4.18	Load compensation integral gain	0.01~10.00s	0.16
P4.19	APR proportional gain	0~100	0
P4.20	APR integral gain	0.01~10.00s	0.01
P4.21	Current compensation coefficient	-1000~4000	1500

Function code	Name	Detailed instruction of parameters	Default value
P4.22	Rated load	0~10000kg	1000
P4.23	Weighing input selection	0: Digital input 1: Analog input of car 2: Analog input of engine room	0
P4.24	Weighing compensation input channel	0: No compensation 1: Communication input 2: Terminal input	0
P4.25	Pre-torque bias	0.0~100.0%	45.0
P4.26	Bias and gain at the braking side	0.000~5.000	2.000
P4.27	Bias and gain at the drive side	0.000~5.000	2.000
P4.28	Analog filter of car weighing	0.00~0.50s	0.10
P4.29	Analog filter of engine room weighing	0.00~0.50s	0.10
P4.30	Smooth filter time of the curve	0~20ms	6
P4.31	Monitoring output selection	0~65535	0
<b>P5 Group Elevator protection parameters</b>			
P5.00	Input phase loss protection	0: Prohibit 1: Enabling 2: Only enabling in running	1
P5.01	Output phase loss protection	0: Prohibit 1: Enabling	1
P5.02	Motor overload protection	0: Disabled 1: Normal motor 2: Variable frequency motor	2
P5.03	Motor overload protection current	20.0%~120.0%	100.0

Function code	Name	Detailed instruction of parameters	Default value
P5.04	Overload pre-warning threshold	20.0%~150.0%	130.0
P5.05	Overload pre-warning selection	0: Corresponds to the rated current of the motor, detecting all the time 1: Corresponds to the rated current of the motor, detecting when constant speed 2: Corresponds to the rated current of the machine, detecting all the time 3: Corresponds to the rated current of the machine, detecting when constant speed	0
P5.06	Overload pre-warning delay time	0.0~30.0s	5.0
P5.07	Automatic fault reset times	0~3	3
P5.08	Fault reset interval	0.1~100.0s	5.0
P5.09	Threshold of over speed deviation	0.1%~50.0%	20.0
P5.10	Detection time of over speed deviation	0.000~10.000s	0.500
P5.11	Braking threshold voltage	320.0~750.0V	700.0
P5.12	Ramp cancelling current delay	0~65535ms	0
P5.13	Reserved	0~65535	0
P6 Group Communication setting (reserved)			
P7 Group Drive information			
P7.00	Year setting	2000~2099	2010
P7.01	Month/date setting	01.01~12.31	01.01
P7.02	Hour/minute setting	00.00~23.59	12.00
P7.03	Rectification module temperature	-20.0~100.0°C	Read only

Function code	Name	Detailed instruction of parameters	Default value
P7.04	Converting module temperature	-20.0~100.0°C	Read only
P7.05	DSP software version	1.00~9.99	Read only
P7.06	MCU software version	1.00~9.99	Read only
P7.07	FPGA software version	1.00~9.99	Read only
P7.08	Software version of car board	1.00~9.99	Read only
P7.09	Software version of group control board	1.00~9.99	Read only
P7.10	Running time displaying of the inverter	0~65535h	Read only
P7.11	Rate power displaying of the inverter	0.4~1200.0kW	Read only
P7.12	Rate current displaying of the inverter	0.1~2000.0A	Read only
<b>A1 Group Floor setting</b>			
A1.00	Calling control mode	0: Full selective 1: Reserved 2: XPM	0
A1.01	Total floor setting	2~64	16
A1.02	Basement setting	0~10	0
A1.03	Fire landing setting	0~A1.01	1
A1.04	Park floor setting	0~A1.01	1
A1.05	Base floor setting	0~A1.01	1
A1.06	Door lock detection (security floor)	0~A1.01	1
A1.07	Start time of security floor	0~2359	0
A1.08	Stop time of security floor	0~2359	0
A1.09	Reserved	0~65535	0
<b>A2 Group Floor displaying</b>			

Function code	Name	Detailed instruction of parameters	Default value
A2.00	1 floor displaying	0~9999	1617
A2.01	2 floor displaying	0~9999	1618
A2.02	3 floor displaying	0~9999	1619
A2.03	4 floor displaying	0~9999	1620
A2.04	5 floor displaying	0~9999	1621
A2.05	6 floor displaying	0~9999	1622
A2.06	7 floor displaying	0~9999	1623
A2.07	8 floor displaying	0~9999	1624
A2.08	9 floor displaying	0~9999	1625
A2.09	10 floor displaying	0~9999	1716
...	...	...	...
A2.63	64 floor displaying	0~9999	2220
<b>H0 Group</b> Input logic setting of main control board			
H0.00	Logic setting 1	0~255	255
H0.01	Logic setting 2	0~255	3
H0.02	Logic setting 3	0~255	14
H0.03	Logic setting 4	0~255	0
H0.04	Reserved	0~255	0
H0.05	Reserved	0~255	0
<b>H1 Group</b> Input logic setting of car control board			
H1.00	Front door logic setting 1	0~255	152
H1.01	Front door logic setting 2	0~255	0
H1.02	Rear door logic setting 1	0~255	0
H1.03	Rear door logic setting 2	0~255	0
H1.04	Reserved	0~255	0
H1.05	Reserved	0~255	0
<b>H2 Group</b> Front door stopping floor			
H2.00	Front door 1~8 floor	0~255	255
H2.01	Front door 9~16 floor	0~255	255
H2.02	Front door 17~24 floor	0~255	255
H2.03	Front door 25~32 floor	0~255	255
H2.04	Front door 33~40 floor	0~255	255



Function code	Name	Detailed instruction of parameters	Default value
H2.05	Front door 41~48 floor	0~255	255
H2.06	Front door 49~56 floor	0~255	255
H2.07	Front door 57~64 floor	0~255	255
H3 Group Rear door stopping floor			
H3.00	Rear door 1~8 floor	0~255	0
H3.01	Rear door 9~16 floor	0~255	0
H3.02	Rear door 17~24 floor	0~255	0
H3.03	Rear door 25~32 floor	0~255	0
H3.04	Rear door 33~40 floor	0~255	0
H3.05	Rear door 41~48 floor	0~255	0
H3.06	Rear door 49~56 floor	0~255	0
H3.07	Rear door 57~64 floor	0~255	0
H4 Group Front/rear door stopping floor			
H4.00	Front/rear door 1~8 floor	0~255	0
H4.01	Front/rear door 9~16 floor	0~255	0
H4.02	Front/rear door 17~24 floor	0~255	0
H4.03	Front/rear door 25~32 floor	0~255	0
H4.04	Front/rear door 33~40 floor	0~255	0
H4.05	Front/rear door 41~48 floor	0~255	0
H4.06	Front/rear door 49~56 floor	0~255	0
H4.07	Front/rear door 57~64 floor	0~255	0
L0 Group Parallel and group control setting			
L0.00	Group number of the elevator	0~10	0

Function code	Name	Detailed instruction of parameters	Default value
L0.01	Up bias floor	0~64	0
L0.02	Down bias floor	0~64	0
L0.03	Parallel home floor	0~64	0
T0 Group Time setting			
T0.00	Open delay	0~500.0s	3.0
T0.01	Reserved	0~500.0s	45.0
T0.02	Return to the home floor delay	0~5000.0s	120.0
T0.03	Free energy-saving delay	0~5000.0s	60.0
T0.04	Brake opening delay	0~5.000s	0.200
T0.05	Brake closing delay	0~5.000s	0.400
T0.06	Starting shake prevention delay	0~5.000s	0.300
T0.07	Direction cancel delay	0~5.000s	0.200
T0.08	Inspection stopping delay	0~5.000s	0.300
T0.09	Fire running delay	0~5.000s	0.000
T0.10	Arrival gong delay	0~5.000s	0.000
T0.11	Thermal protection reset delay	0~5000s	600
T0.12	Pre-opening delay	0~5.000s	0
T0.13	Peristaltic landing overtime	0~5.000s	0
T0.14	Speed reference delay	0~5.000s	0.500
T0.15	Braking voltage shifting delay	0~5.000s	0
T0.16	Opening delay keeping time	0~500.0s	30.0
T0.17	Entire running protection time	0~100.0s	45.0

Function code	Name	Detailed instruction of parameters	Default value
T0.18	Single floor running protection time	0~100.0s	45.0
T0.19	Fast arrival opening delay	0~65535	0
T0.20	Beam keeping failure time	0~65535s	0
T0.21	Reserved	0~65535	0
...	...	...	...
T0.28	Reserved	0~65535	0
<b>F0 Group Function setting</b>			
F0.00	High/low voltage detection	0: Only detect high voltage 1: Only detect low voltage 2: Detect high/low voltage	2
F0.01	Hand door enabling	0: Invalid 1: Arrival without open/closed detection. The elevator continues to run after switch off the door lock.	0
F0.02	Closing output delay	0: Do not output closing signal after the door is closed 0.1~600.0s: closing keeping time after the door is closed Set to 600, the door keeps closed	0.5
F0.03	Fire safety mode	0: China fire safety 1: Australia fire safety 2: Britain fire safety 3: Special function for fire safety 2012	0
F0.04	Closing output condition of dual doors	0: Dual door output closing signal when the door lock is blocked 1: End the closing command after the door closed	0

Function code	Name	Detailed instruction of parameters	Default value
F0.05	Floor opening mode of parallel outside calling	0: Main elevator and sub-elevator opening at the same time 1: Main elevator opening 2: Sub-elevator opening	0
F0.06	Reset mode of running fault overtime	0: Manual reset 1: Return to leveling automatically	0
F0.07	MF definition of IND	0: Original definition 1: Keep opening delay 2: Select front/rear door 3: Fire fighter input	1
F0.08	Internal command limit times	0: Invalid 1-5: Record signal times limit when LL	0
F0.09	Dual door control mode	0: Dual control box mode (need rear door logic setting) 1: Single control box mode	1
F0.10	Fire output	0: Output after forced landing 1: Output only in the home floor after forced landing	
F0.11	Floor internal command opening enabling	0: Disabled 1: Enabled	0
F0.12	LIN1 multi-function definition	0~40 0~2: Reserved 3: Medium speed down forced speed-changing switch 4: Medium speed up forced speed-changing switch 5: High speed down forced speed-changing switch 6: High speed up forced speed-changing switch 7: Down limit 8: Up limit	24

Function code	Name	Detailed instruction of parameters	Default value
F0.13	LIN2 multi-function definition	9: Reserved 10: Inspection signal 11: Inspection up button signal 12: Inspection down button signal 13: Up door area (rear door opening inspection) 14: Down door area 15-16: Reserved 17: Lock elevator signal 18: Contact detection of the drive output contactor 19: Contact detection of the brake contactor 20: Brake travel switch detection 21: Motor thermal protection 22: Fire action input 23: Reserved 24: Full load signal 25: Overload signal 26-27: Reserved 28: Pre-opening feedback 29: Reserved	25
F0.14	LIN3 multi-function definition	30: Earthquake 31-32: Reserved 33: Open 34: Close 35: UPS output detection 36: Dual brake travel detection 37: Star-delta output detection 38: UCM input signal 39: Third brake travel detection 40: Reserved	30

Function code	Name	Detailed instruction of parameters	Default value
F0.15	MF output in the car	0~65535 Unit: Define RDC port of DC01, LED light corresponding to PAS Ten: Define RDO port of DC01, LED light corresponding to DOD 0: Closing/opening output light of rear door 1: Opening delay light 2: Mapping PLC OUT1 (Y5) 3: Mapping PLC OUT2 (Y6) 4: Low speed closing signal	10
F0.16	Test mode	0~65535 1: Allow communication reset at drive fault 8: Close at fast arrival and shield calling 16: Cancel double click number clearance 64: Enable peristaltic UCM protection	0
F0.17	Relative selection of CAN communication	0~65535 1: Open protocol (Both calling board and car board are connected to the same line.) 2: OL voltage>FL voltage>LL voltage for weighing sensor of the car top board 4: Command number clearance after fast stop at door area, if not, deceleration point number clearance 16: When the internal calling is open protocol, the external calling adopts internal protocol connected to the external calling line or open protocol connected to the internal calling line 32: Communicating door operator	0

Function code	Name	Detailed instruction of parameters	Default value
F0.18	Relative selection of elevator running	0~65535 1: Calling below 32 floor connected to inside line 2: Parallel calling scan in cycle 4: Speed involved in parallel control calculation 8: Communication IC card enabling 16: No number clearance of internal calling remote reverse enabling 32: Home floor opening standby enabling 64: During home floor opening standby, energy saving enabling (Door beam will automatically cancel energy saving in the state.) 128: Each floor opening standby enabling (Energy saving setting will be valid in the state.)	0
F0.19	Drive CD phase sampling	0~65535 1: The Max. value in the latest running 2: The Min. value in the latest running 4: The bias out of the latest running calculation	0
F0.20	Filter coefficient of stop curve	0~65535 Valid range 1~255 (generally unnecessary to set the value, modifiable when the elevator shakes after stopping in door area)	0
F0.21	Peristaltic landing distance	0~65535 Valid range 10~200mm (modifiable when the asynchronous motor drives by pulley or long floor rope slides)	0

Function code	Name	Detailed instruction of parameters	Default value
F0.22	UPS application	0~65535 0: 220V power supply (The switching of drive power supply is controlled by Y6. Set KPWR input to normally closed logic. Detect UPS output feedback and bus voltage. After leveling open delay, disconnect Y6.) 1: 380V power supply (The switching of drive power supply is controlled by UPS itself. UPS bus voltage detection is unnecessary. After leveling open delay, output Y6, KPWR input optional.)	0
F0.23	DS multi-function definition in the car	0~65535 0: Original definition 1: Opening keeping delay button 2: Front/rear door selection 3: Car firefighter input	0
F0.24	Dual door area selection	0~65535 1: Enable dual door area 2: Dual door area replaces slow limit switch 4: Return to leveling and correct pulses in the state of dual door area	0
F0.25	Reserved	0~65535	0
F0.26	Start time 1 of time sharing service	0~2359 Thousands and hundreds: Hour Tens and ones: Minute	0
F0.27	Stop time 1 of time sharing service	0~2359 Thousands and hundreds: Hour Tens and ones: Minute	0
F0.28	Time 1 of time sharing service Stop at 1~16 floors	0~65535	0



Function code	Name	Detailed instruction of parameters	Default value
F0.29	Time 1 of time sharing service Stop at 17~32 floors	0~65535	0
F0.30	Time 1 of time sharing service Stop at 33~48 floors	0~65535	0
F0.31	Time 1 of time sharing service Stop at 49~64 floors	0~65535	0
F0.32	Start time 2 of time sharing service	0~2359 Thousands and hundreds: Hour Tens and ones: Minute	0
F0.33	Stop time 2 of time sharing service	0~2359 Thousands and hundreds: Hour Tens and ones: Minute	0
F0.34	Time 2 of time sharing service Stop at 1~16 floors	0~65535	0
F0.35	Time 2 of time sharing service Stop at 17~32 floors	0~65535	0
F0.36	Time 2 of time sharing service Stop at 33~48 floors	0~65535	0
F0.37	Time 2 of time sharing service Stop at 49~64 floors	0~65535	0
F0.38	Start time 3 of time sharing service	0~2359 Thousands and hundreds: Hour Tens and ones: Minute	0
F0.39	Stop time 3 of time sharing service	0~2359 Thousands and hundreds: Hour Tens and ones: Minute	0

Function code	Name	Detailed instruction of parameters	Default value
F0.40	Time 3 of time sharing service Stop at 1~16 floors	0~65535	0
F0.41	Time 3 of time sharing service Stop at 17~32 floors	0~65535	0
F0.42	Time 3 of time sharing service Stop at 33~48 floors	0~65535	0
F0.43	Time 3 of time sharing service Stop at 49~64 floors	0~65535	0
F0.50	Reserved	0~65535	0
...	...	...	...
F0.57	Front door 1~16 communicating IC card open floors	0~65535	0
F0.58	Front door 17~32 communicating IC card open floors	0~65535	0
F0.59	Front door 33~48 communicating IC card open floors	0~65535	0
F0.60	Front door 49~64 communicating IC card open floors	0~65535	0
F0.61	Rear door 1~16 communicating IC card open floors	0~65535	0
F0.62	Rear door 17~32 communicating IC card open floors	0~65535	0

Function code	Name	Detailed instruction of parameters	Default value
F0.63	Rear door 33~48 communicating IC card open floors	0~65535	0
F0.64	Rear door 49~64 communicating IC card open floors	0~65535	0
F0.65	Reserved	0~65535	0
...	...	...	...
F0.70	Y5 relay output definition	0~65535 0: Original definition 1: Output contactor control 1 2: Star-delta output 3: Brake contactor control 1 4: Brake contactor control 2 5: Fire return 6: Front door opening output 7: Front door closing output 8: Rear door opening output 9: Rear door closing output	0
F0.71	Y6 relay output definition	10: Pre-opening output 11: Low speed signal 12: UPS control 13: Lock return 14: Energy saving output 15: Forced closing output 16: Elevator up signal 17: Elevator down signal 18: Major fault signal 19: Peristaltic UCM protection 20: Reserved 21~99: No definition	
F0.72	Reserved	0~65535	0
...	...	...	...

Function code	Name	Detailed instruction of parameters	Default value
F0.75	Analog LL set voltage	0~65535	0
F0.76	Analog FL set voltage	0~65535	0
F0.77	Analog OL set voltage	0~65535	0
...	...	...	...
F0.99	Reserved	0~65535	0
<b>U0 Group Calling command</b>			
U0.00	Manual calling	0~64 refers to the calling of current floors 0 or invalid floor: no operation	0
U0.01	Random running	0~65535 random running The running times is 10 times of the set value	0
<b>U1 Group System monitoring</b>			
U1.00	Running time low bit	0~65535	Read only
U1.01	Running time high bit	0~65535	Read only
U1.02	Total running time low bit	0~65535min	Read only
U1.03	Total running time high bit	0~65535min	Read only
U1.04	Current elevator reference speed	0~9999mm/s	Read only
U1.05	Reference frequency monitoring	0.00~400.00Hz	Read only
U1.06	Magnetic pole position angle	0.00~360.00	Read only
U1.07	Static autotuning detection current	0.0~300.0%	Read only
U1.08	C phase sampling	0~1024	Read only
U1.09	D phase sampling	0~1024	Read only
U1.10	Current height of the elevator	0.00~600.00m	Read only
U1.11	Current floor of the elevator	1~64	Read only
U1.12	Leveling distance	0.000~0.500m	Read only
U1.13	Low bit of input terminal state	0~65535	Read only

Function code	Name	Detailed instruction of parameters	Default value
U1.14	High bit of input terminal state	0~65535	Read only
U1.15	Extension input terminal state	0~65535	Read only
U1.16	Number clearance tip	0~65535	Read only
U1.17	Input terminal state in the car	0~65535	Read only
U1.18	Output terminal state of the main board	0~65535	Read only
U1.19	Current feedback speed of the elevator	0~65535	Read only
U1.20	Running state of the elevator	0~65535	Read only
U1.21	Output current	0.0~1000.0A	Read only
U1.22	Output voltage	0~1000V	Read only
U1.23	Output frequency	0.00~999.99Hz	Read only
U1.24	Output rotating speed	0~10000rpm	Read only
U1.25	Output power	0.0~200.0kW	Read only
U1.26	Bus voltage	0.0~1000.0V	Read only
U1.27	Torque command	-250.0~250.0%	Read only
U1.28	Torque compensation	-250.0~250.0%	Read only
U1.29	Current load	0~10000kG	Read only
U1.30	Calculated deceleration distance	0~60.000m	Read only
U1.31	Calculated stopping distance	0~60.000m	Read only
U1.32	Analog input voltage	0~10.0V	Read only
U1.33	Extension output terminal state	0~65535	Read only
U1.34	Terminal output state in the car	0~65535	Read only
U1.35	DM03 state	0~65535	Read only

Function code	Name	Detailed instruction of parameters	Default value
U2 Group Hoistway information			
U2.00	Total height of the floor	0~600.00m	Read only
U2.01	Low speed down forced deceleration distance	0~60.000m	Read only
U2.02	Low speed up forced deceleration distance	0~60.000m	Read only
U2.03	Medium speed down forced deceleration distance	0~60.000m	Read only
U2.04	Medium speed up forced deceleration distance	0~60.000m	Read only
U2.05	High speed down forced deceleration distance	0~60.000m	Read only
U2.06	High speed up forced deceleration distance	0~60.000m	Read only
U2.07	Longest floor distance	0~60.000m	Read only
U2.08	Shortest floor distance	0~60.000m	Read only
U2.09	Reserved	0~65535	Read only
E0 Group Fault record			
E0.00	Total fault records	0~30	AL 30
E0.01	Serial number of fault record	1~30, 1 is the latest one	No. 01
E0.02	Fault code	1~139	Ec 139
E0.03	Year of fault	2000~2099	2013
E0.04	Month/date of fault	0~1231	40 10 1
E0.05	Hour/minute of fault	0~2359	F 12 00
E0.06	Second of fault	0~59	SEC 00
E0.07	Floor at fault	0~64	FL 16

Function code	Name	Detailed instruction of parameters		Default value
E0.08	Low 16-bit input terminal state of the main board at fault	1.0000~1.FFFF	1FFFF	
E0.09	High 16-bit input terminal state of the main board at fault	2.0000~2.FFFF	2FFFF	
E0.10	Output terminal state of the main board at fault	2.0000~2.2FFF	32FFF	
E0.11	Rated speed of the elevator at fault	0~9999mm/s	3800	
E0.12	Elevator position at fault	0~999.99m	12800	
E0.13	Bus voltage at fault	0.0~9999.9V	05800	
E0.14	Output current at fault	0.0~9999.9A	00800	
E0.15	Running frequency at fault	0.00~999.99Hz	02800	
E0.16	Reserved	0~65535	00000	
E0.17	Reserved	0~65535	00000	
E0.18	Reserved	0~65535	00000	
E0.19	Reserved	0~65535	00000	

## Chapter 6 Function parameters

### 6.1 Original debugging interface

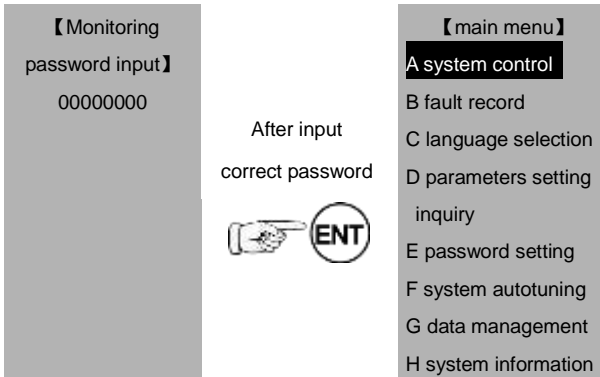

The monitoring password can only enter into A, B, E and H in the main menu. After the entry of E, only the monitoring interface password can be modified.

If it is necessary to shift into the other modes after password entering, power off and enter again. After inputting the monitoring password, pressing ESC can shift into debugging or factory mode.



The original value of monitoring password and debugging password is 00000000.

### 6.2 System monitoring

#### 6.2.1 System monitoring---calling and running state

##### 6.2.1.1 Calling state

After entering into the calling and running state, move the cursor into the called floor number, press ENT to record the car calling and press DOWN to enter the lower button and press UP to enter the upper button.

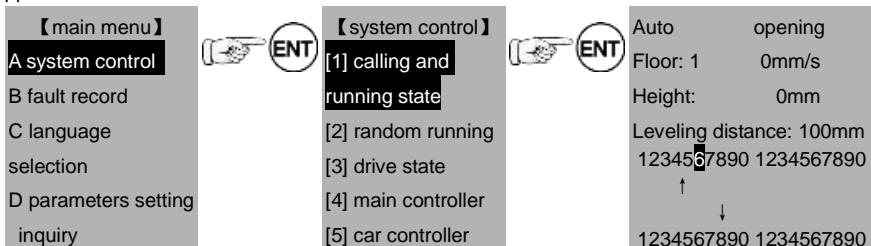



E password setting  
 F system autotuning  
 G data management  
 H system information



**6.2.1.2 Running state**

```

Auto      opening
Floor: 1   0mm/s
Height:    0mm
Leveling distance: 100mm
1234567890 1234567890
  ↑
  ↓
1234567890 1234567890
    
```

The interface will display the state of the elevator such as auto, maintenance, fire safety, attendant, door locked, fault, overload and full load, the current floor and height, the leveling distance and the state of door operator.

Move the cursor onto the floor in need of landing calling, and then press ENT to record car commands. The up arrow stands for the current recorded UP command while the down arrow stands for the current recorded DOWN command.

**6.2.2 System monitoring---random running**

After entering into the interface, the elevator is in the random running state automatically.

```

Auto      opening
Floor: 1   0mm/s
Height:    0mm
Leveling distance: 100mm
1234567890 1234567890
  ↑
  ↓
1234567890 1234567890
    
```

**6.2.3 System monitoring---drive state**

【main menu】  
 A system control  
 B fault record



【system control】  
 [1] calling and running state



【drive state】  
 1. Reference speed:0mm/s  
 2. Feedback speed:0mm/s

C language selection  
 D parameters setting inquiry  
 E password setting  
 F system autotuning  
 G data management  
 H system information

[2] random running  
 [3] drive state  
 [4] main controller  
 [5] car controller

3. Reference frequency: 000.00Hz  
 4. Output frequency: 000.00Hz  
 5. Output speed: 0rpm  
 6. Output current: 0000.0A  
 7. Output voltage: 000.0V  
 8. Output power: 000.0kW  
 9. Bus voltage: 000.0V

**6.2.4 System monitoring---main controller**

**【main menu】**  
**A system control**  
 B fault record  
 C language selection  
 D parameters setting inquiry  
 E password setting  
 F system autotuning  
 G data management  
 H system information



**【system control】**  
 [1] calling and running state  
 [2] random running  
 [3] drive state  
**[4] main controller**  
 [5] car controller



**【input signal 1-32】**  
 1 2 3 4 5 6 7 8  
 9 10 11 12 13 14 15 16  
 17 18 19 20 21 22 23 24  
 25 26 27 28 29 30 31 32  
**【output relay 1-12】**  
 1 2 3 4 5 6 7 8  
 9 10 11 12  
**【use the up/down key to turn page and inquiry the state and function】**

Check the state of each point when the output/input point of I/O board changes and use the UP/DOWN key to turn page and inquire the definition of the output/input point, as shown below:

**【input signal 1-32】**  
 1 low speed down forced speed-changing  
 2 low speed up forced speed-changing  
 3 medium speed down forced speed-changing  
 4 medium speed up forced speed-changing  
 5 high speed down



10 inspection signal  
 11 inspection up signal  
 12 inspection down signal  
 13 up door area  
 14 down door area  
 15 middle door area  
 16 contact of the safety contactor  
 17 contact of the door lock contactor  
 18 drive output



20 brake travel switch  
 21 motor thermal protection  
 22 fire action input  
 23 UPS input signal  
 24 high voltage inspection of the safety circuit  
 25 high voltage inspection of the car door lock  
 26 high voltage inspection of the hall

forced  
 speed-changing  
 6 high speed up forced  
 speed-changing  
 7 down limit  
 8 up limit  
 9 emergency electric  
 running

contactor  
 19 contact of the  
 brake contactor

door lock  
 27 hardware enabling 28  
 pre-opening feedback  
 29 pre-opening  
 adhesion

**6.2.5 System monitoring---car controller**

**【main menu】**  
 A system control  
 B fault record  
 C language selection  
 D parameters setting  
 inquiry  
 E password setting  
 F system autotuning  
 G data management  
 H system information



**【system control】**  
 [1] calling and  
 running state  
 [2] random running  
 [3] drive state  
 [4] main controller  
 [5] car controller



**【car input signal 1-16】**  
 1 2 3 4 5 6 7 8  
 9 10 11 12 13 14 15 16  
  
**【car output signal 1-13】**  
 1 2 3 4 5 6 7 8  
 9 10 11 12 13  
  
**【use the up/down key  
 to turn page and inquire  
 the state and function】**



Check the changing of each point when the input/output point on the car top board EC-CTB and use the UP/DOWN key to turn page and inquire the definition of the output/input point.

**6.3 Fault history record**

**【main menu】**  
 A system control  
 B fault record  
 C language selection  
 D parameters setting  
 inquiry  
 E password setting  
 F system autotuning  
 G data management  
 H system information



**【fault record】**  
 The 1<sup>st</sup> one of 3  
 Fault code: 30 Floor: 1  
 2010-12-10 23:24:12  
 Fault instruction:  
 30# safety circuit fault  
**【press ENT to check  
 the fault state】**



The system state when  
 the fault occurs  
 Input state 1: 0000  
 Input state 2: 000E  
 Input state: 000  
 Elevator speed: 0m/s  
 Car position: 70mm  
 Bus voltage: 0557.8  
 Current when fault  
 occurs: 0000.0A  
 Running frequency:  
 000.0Hz  
**【press ENT to return】**

The fault history record: the first one stands for the latest fault and the floor stands for the elevator floor where the fault occurs. The detailed fault time and instructions can be attained by pressing ENT.

Please refer to chapter 12.6 for the other faults instructions.

## 6.4 Language selection

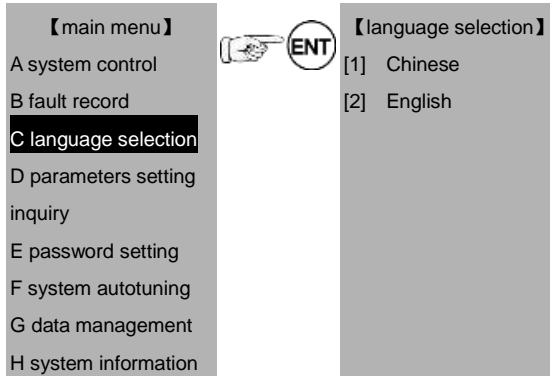

## 6.5 Parameters setting inquiry

Move the cursor into D after entering into the main menu and press ENT into the parameters setting, the main menu is shown as below:

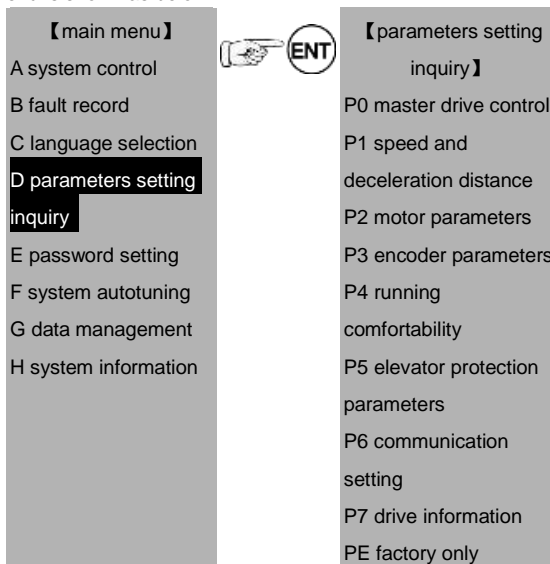

6.5.1 Parameters setting---master drive control

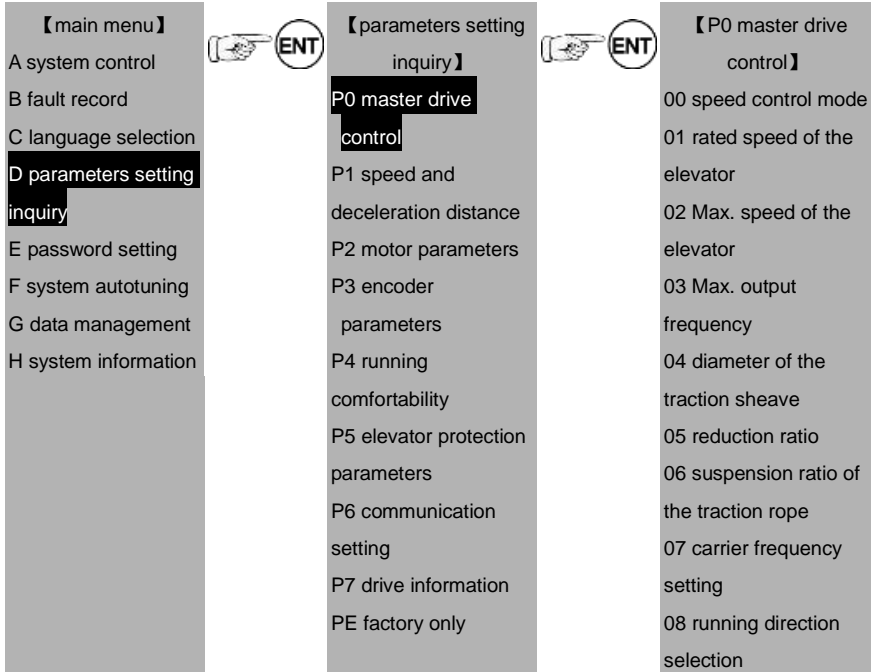

Function code	Instruction	Setting range 【default value】	Remarks
P0_00	Speed control mode	0-2 【1】	Not modify in running
Select the speed control mode of the system. 0: VC without PG, only suitable on the debugging mode of the asynchronous master 1: VC with PG, encoder is needed 2: V/F control, only suitable on the debugging mode of the asynchronous master			

Function code	Instruction	Setting range 【default value】	Remarks
P0_01	Rated speed of the elevator	0.100~6.000m/s 【1.750】	Not modify in running
Input this parameter according to the name plate of the elevator. This is the basic value of the actual speed of the elevator. Redo hoistway autotuning after modification.			

Function code	Instruction	Setting range 【default value】	Remarks
P0_02	Max. speed of the elevator	0.100~6.000m/s 【1.750】	Not modify in running
This is the upper limit of the actual speed of the elevator.			

Function code	Instruction	Setting range 【default value】	Remarks
P0_03	Max. output frequency	3.00~400.00Hz 【27.8】	Not modify in running
This parameter is used to set the Max. output frequency and the Max. linear speed of the elevator will be limited by this value. Set the Max. speed of the elevator, the rated frequency of the motor, the rated speed of the motor and the resolution of the encoder, and then the parameter will be calculated automatically.			

Function code	Instruction	Setting range 【default value】	Remarks
P0_07	Carrier frequency setting	1.0~16.0kHz 【6.0】	Not modify in running
The advantages of high carrier frequency: optimal current waveform, low current harmonics, low motor noise; Disadvantages of high carrier frequency: increased switch loss, increased inverter temperature rise, affected inverter output capacity, derated operation of the inverter, increased leakage current of the inverter as well as increased electromagnetic interference to the outside. If low carrier frequency is used, the situation will be contrary. Too low carrier frequency will cause unstable operation at low frequency, lowered torque and even oscillation.			

Function code	Instruction	Setting range 【default value】	Remarks
P0_08	Running direction	0-1 【0】	Not modify in running
This parameter is used to change the running direction of the master. When the climbing command direction reverses to the actual running command, this parameter can be changed.			

6.5.2 Parameters setting---speed and deceleration distance

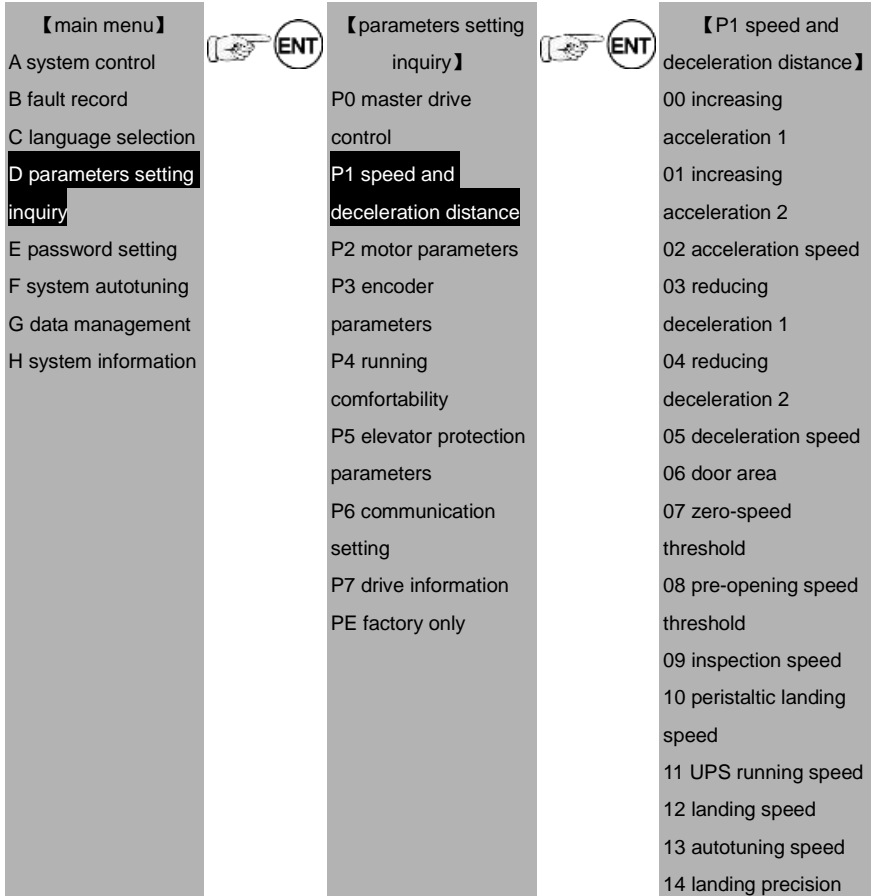

Function code	Instruction	Setting range 【default value】	Remarks
P1_00	Increasing acceleration 1 (fast acceleration at the beginning stage)	0.001~9.999m/s <sup>3</sup> 【0.350】	Not modify in running
P1_01	Increasing acceleration 2 (fast acceleration at the end stage)	0.001~9.999m/s <sup>3</sup> 【0.350】	
P1_02	Acceleration speed	0.001~9.999m/s <sup>2</sup> 【0.700】	

Function code	Instruction	Setting range 【default value】	Remarks
P1_03	Reducing deceleration 1 (fast deceleration at the beginning stage)	0.001~9.999m/s <sup>3</sup> 【0.350】	
P1_04	Reducing deceleration 2 (fast deceleration at the beginning stage)	0.001~9.999m/s <sup>3</sup> 【0.350】	
P1_05	Deceleration speed	0.001~9.999m/s <sup>2</sup> 【0.700】	

	<ul style="list-style-type: none"> <li>◆ The set acceleration speed or deceleration speed cannot exceed 3 times of the corresponding increasing acceleration or reducing deceleration.</li> </ul>
---	---

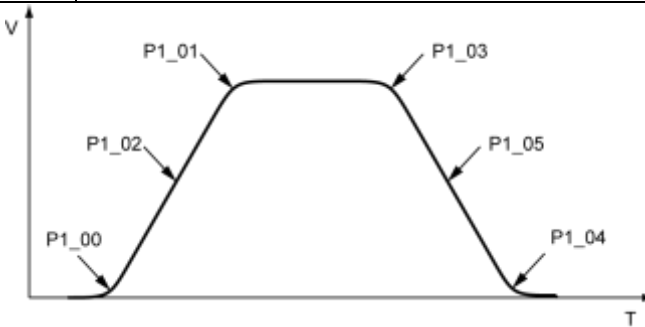



Figure 6-1 Parameters diagram of S curve

Function code	Instruction	Setting range 【default value】	Remarks
P1_06	Door area	100~999 【200】	Not modify in running

	<ul style="list-style-type: none"> <li>◆ If the total floor≥3, parameter P1_06 can measure the door area (length) by hoistway autotuning. If the total floor=2, set the value manually according to the actual situation. Before fast debugging leveling, the precision can be adjusted by modifying the parameter.</li> <li>◆ After hoistway autotuning or save, the value is limited less than 400 automatically.</li> </ul>
---	--



Function code	Instruction	Setting range 【default value】	Remarks
P1_07	Zero-speed threshold	0~0.050m/s 【0】	Not modify in running
Zero-speed threshold means the Min. running speed before braking. Generally, it does not need setting.			

Function code	Instruction	Setting range 【default value】	Remarks
P1_08	Pre-opening speed threshold	0~0.500m/s 【0.050】	Not modify in running
When the running speed of the elevator is lower than the pre-opening speed threshold, the pre-opening output will be allowed and Y5 will output at the same time.			



Function code	Instruction	Setting range 【default value】	Remarks
P1_09	Inspection speed	0~0.630m/s 【0.200】	Not modify in running
P1_10	Peristaltic landing speed	0~0.200m/s 【0.03】	
P1_11	UPS running speed	0~1.000m/s 【0.100】	
P1_12	Landing speed	0~1.000m/s 【0.200】	
P1_13	Autotuning speed	0~1.000m/s 【0.100】	
The above parameters are the Max. allowable speed of the elevator in different running modes.			

Function code	Instruction	Setting range 【default value】	Remarks
P1_14	Landing precision	0~100mm 【50】	Not modify in running
If the leveling overshoots, enlarge the running distance of the elevator on the basis of original leveling precision; if the leveling lacks, reduce the running distance of the elevator on the basis of original leveling precision.			

Function code	Instruction	Setting range 【default value】	Remarks
P1_16	High-speed current loop proportional coefficient	0~65535 【0】	Not modify in running
P1_17	High-speed current loop integral coefficient	0~65535 【0】	

The parameters do not need setting usually. When the load changes, the master will show different features at high/low speed. Then current loop shifting function can be enabled (0: disabled) and the shifting mode is the same as speed shifting (see P4\_08 and P4\_09).

**6.5.3 Parameters setting--motor parameters**

<p>【main menu】</p> <p>A system control</p> <p>B fault record</p> <p>C language selection</p> <p><b>D parameters setting inquiry</b></p> <p>E password setting</p> <p>F system autotuning</p> <p>G data management</p> <p>H system information</p>		<p>【parameters setting inquiry】</p> <p>P0 master drive control</p> <p>P1 speed and deceleration distance</p> <p><b>P2 motor parameters</b></p> <p>P3 encoder parameters</p> <p>P4 running comfortability</p> <p>P5 elevator protection parameters</p> <p>P6 communication setting</p> <p>P7 drive information</p> <p>PE factory only</p>		<p>【P2 motor parameter】</p> <p><b>00 Motor type selection</b></p> <p>01 Rated power of the motor</p> <p>02 Rated frequency of the motor</p> <p>03 Rated speed of the motor</p> <p>04 Rated voltage of the motor</p> <p>05 Rated current of the motor</p> <p>06 Resistance of the stator</p> <p>07 Resistance of the rotor</p> <p>08 Inductance of the stator and rotor</p> <p>09 Mutual inductance of the stator and rotor</p> <p>10 Current without load</p>
---	---	--	---	---

 <b>Caution</b>	<p>◆ Parameters of P2 will not restore to factory values except the rated power, rated current and rated voltage of the motor.</p>
--	--

Function code	Instruction	Setting range 【default value】	Remarks
P2_00	Motor type selection	0-1 【1】	Not modify in running
Select the motor type 0: Asynchronous master 1: Synchronous master			

	<p>◆ After changing the motor type, it needs to change the corresponding parameters of the encoder. When the synchronous changes into asynchronous motor, P2_06~P2_10 will match according to the rated power of the motor.</p>
---	---





Function code	Instruction	Setting range 【default value】	Remarks
P2_01	Rated power of the motor	0.1~150.0kW 【7.5】	Not modify in running
P2_02	Rated frequency of the motor	3Hz~400Hz 【27.8】	
P2_03	Rated speed of the motor	0~30000rpm 【167】	
P2_04	Rated voltage of the motor	0~460V 【380】	
P2_05	Rated current of the motor	0.1~1000.0A 【15】	
Input above parameters correctly when master autotuning. After modifying the rated power of the asynchronous, P2_06~P2_10 will match according to the rated power of the motor.			

Function code	Instruction	Setting range 【default value】	Remarks
P2_06	Resistance of the stator	0~65.535Ω 【1.41】	Not modify in running
P2_07	Resistance of the rotor	0~65.535Ω 【1.41】	
P2_08	Inductance of the stator and rotor	0~6553.5mH 【141】	
P2_09	Mutual inductance of the stator and rotor	0~6553.5mH 【140】	
P2_10	Current without load	0~655.35A 【1.5】	
Above parameters will update automatically after autotuning of the master. These parameters are			

Function code	Instruction	Setting range 【default value】	Remarks
the basic ones of high performance vector control, having direct impact on the performance control.			

	◆ Do not modify above parameters without permits; otherwise, wrong parameters may cause motor damage.
---	---

**6.5.4 Parameters setting--encoder parameters**

<p><b>【main menu】</b></p> <p>A system control</p> <p>B fault record</p> <p>C language selection</p> <p><b>D parameters setting inquiry</b></p> <p>E password setting</p> <p>F system autotuning</p> <p>G data management</p> <p>H system information</p>	 	<p><b>【parameters setting inquiry】</b></p> <p>P0 master drive control</p> <p>P1 speed and deceleration distance</p> <p>P2 motor parameters</p> <p><b>P3 encoder parameters</b></p> <p>P4 running comfortability</p> <p>P5 elevator protection parameters</p> <p>P6 communication setting</p> <p>P7 drive information</p> <p>PE factory only</p>	 	<p><b>【P3 encoder parameters】</b></p> <p><b>00 Encoder type selection</b></p> <p>01 Encoder resolution</p> <p>02 Encoder direction</p> <p>03 Disconnection detection time of the encoder at low speed</p> <p>04 Disconnection detection time of the encoder at high speed</p> <p>05 Reverse detection time of the encoder</p> <p>06 Magnetic pole position amplitude gain</p> <p>07 Magnetic pole position of C phase</p> <p>08 Magnetic pole position of D phase</p> <p>09 Initial position of the magnetic pole</p> <p>10 Static identification current</p> <p>11 Pulse counting direction</p>
--	---	---	---	--

	◆ Parameters of P3 will not restore to factory values.
---	--

Function code	Instruction	Setting range 【default value】	Remarks
P3_00	Encoder type selection	0-3 【1】	Not modify in running
<p>Select the encoder type. Generally, the asynchronous master is set to 0 and applying I/O board AJ2 encoder interface. The asynchronous master is set to be 1 and apply main control board CN3 encoder interface.</p> <p>0: Incremental encoder (Asynchronous master)            1: SIN/COS encoder            2: UVW encoder            3: Endat encoder</p>			



- ◆ When using Heidenhain 1313 encoder, it needs to select the encoder type 3 and install Endat encoder PG card additionally.

Function code	Instruction	Setting range 【default value】	Remarks
P3_01	Encoder resolution	1~10000 【2048】	Not modify in running
<p>Set the pulse number of the encoder. The incorrect parameter make the master not work normally.</p>			

Function code	Instruction	Setting range 【default value】	Remarks
P3_02	Encoder direction	0-1 【0】	Not modify in running
<p>In vector control mode, the parameter must be set correctly; otherwise, the motor cannot work normally.</p>			

Function code	Instruction	Setting range 【default value】	Remarks
P3_03	Disconnection detection time of the encoder at low speed	0.0~10.0s 【1.0】	Not modify in running
P3_04	Disconnection detection time of	0.0~10.0s 【1.0】	

	the encoder at high speed	
P3_05	Reverse detection time of the encoder	0.0~10.0s <b>【1.0】</b>

Above parameters are the detection time of the encoder fault. Setting 0 can cancel the fault protection. Ensure the braking is open or not when reporting the encoder fault and ensure whether the elevator is sliding when reverse fault occurs to the encoder.

Function code	Instruction	Setting range <b>【default value】</b>	Remarks
P3_06	Magnetic pole position amplitude gain	0.50~1.50 <b>【1.00】</b>	Not modify in running
P3_07	Magnetic pole position of C phase	0~9999 <b>【395】</b>	
P3_08	Magnetic pole position of D phase	0~9999 <b>【395】</b>	

The setting of above parameters is relative to the static autotuning of synchronous master and ensures the accuracy of the static autotuning, generally, in no need of change.

	<ul style="list-style-type: none"> <li>◆ The three parameters can be acquired by rotary autotuning;</li> <li>◆ The three parameters can be corrected after hoistway autotuning;</li> <li>◆ F0_19=4, inspection running for one cycle, check the magnetic pole position of C/D phase in drive monitoring;</li> <li>◆ After power off, disconnect 1387 encoder, then power on again and check the magnetic pole position of C/D phase in drive monitoring.</li> </ul>
---	---

Function code	Instruction	Setting range <b>【default value】</b>	Remarks
P3_09	Initial position of the magnetic pole	0.00~360.00 <b>【0.00】</b>	Not modify in running

This parameter will update automatically after autotuning. It is the most important parameter of master running and can not be modified.



Function code	Instruction	Setting range 【default value】	Remarks
P3_10	Static identification current	10.0-150.0% 【50】	Not modify in running
<p>This parameter is used to set the percentage of the identification current to the rated current of the motor. According to the master, it can be set 40%~60%. After static autotuning, U1_07 approaches 80% and does not exceed 120%; otherwise, modify the parameter.</p>			

Function code	Instruction	Setting range 【default value】	Remarks
P3_11	Pulse counting direction	0: do not change 【0】 2: reverse for the synchronous motor 4: reverse for the asynchronous motor	Not modify in running
<p>When the elevator goes up, if the height of the floor is decreasing, please change the value of P3_11.</p>			

	<p>◆ Please judge the counting direction when hoistway autotuning. The real-time height of the elevator will increase when the elevator is raising; otherwise modify the parameter.</p>
---	---

Function code	Instruction	Setting range 【default value】	Remarks
P3_12	SIN/COS encoder phase line	0~65535 【0】	Not modify in running
<p>CD phase line selection for 1387 encoder</p> <p>0: Corresponding detection of CD positive/negative signal</p> <p>1: Cross detection of CD positive/negative signal</p>			

**6.5.5 Parameters setting--running comfortability**

<p>【main menu】</p> <p>A system control</p> <p>B fault record</p>		<p>【parameters setting inquiry】</p> <p>P0 master drive</p>		<p>【P4 running comfortability】</p> <p>00 ASR low speed</p>
--	---	--	---	--

C language selection  
**D parameters setting inquiry**  
 E password setting  
 F system autotuning  
 G data management  
 H system information

control  
 P1 speed and deceleration distance  
 P2 motor parameters  
 P3 encoder parameters  
**P4 running comfortability**  
 P5 elevator protection parameters  
 P6 communication setting  
 P7 drive information  
 PE factory only

**proportional gain**  
 01 ASR low speed integral time  
 02 Speed detection low speed filter times  
 03 Switch low point frequency  
 04 ASR high speed proportional gain  
 05 ASR high speed integral time  
 06 Speed detection high speed filter times  
 07 Switch high point frequency  
 08 ACR proportional coefficient P  
 09 ACR integral coefficient I  
 10 ACR filter coefficient  
 11 Slip compensation rate of drive side  
 12 Slip compensation rate of braking side  
 13 Torque upper limit  
 14 Load compensation enabling  
 15 Load compensation time  
 16 Reducing time of load compensation  
 17 ASR proportional gain  
 18 ASR integral time  
 19 APR proportional gain  
 20 APR integral time  
 21 Current compensation



		coefficient
		22 Rated load
		23 Weighing input selection
		24 Weighing compensation input channel
		25 Pre-torque bias
		26 Bias and gain at the braking side
		27 Bias and gain at the drive side
		28 Analog input filter of car weighing
		29 Analog input filter of engine room
		30 Smooth filter time of the curve

Function code	Instruction	Setting range 【default value】	Remarks
P4_00	ASR low speed proportional gain	0~100 【20】	Not modify in running
P4_01	ASR low speed integral time	0.01~10.00s 【0.50】	
P4_02	Speed detection low speed filter times	0~8 【0】	
P4_03	Switch low point frequency	0.00Hz~10.00Hz 【2.00】	
P4_04	ASR high speed proportional gain	0~100 【20】	
P4_05	ASR high speed integral time	0.01~10.00s 【0.60】	
P4_06	Speed detection high speed filter times	0~8 【0】	
P4_07	Switch high point frequency	0~400 【5.00】	
<p>The above parameters are only valid for vector control. When under the low point switch frequency (P4_03), speed loop parameter PI is P4_00 and P4_01, when over the high low point switch frequency (P4_07), speed loop parameter PI is P4_04 and P4_05. Please refer to following figure for details.</p>			

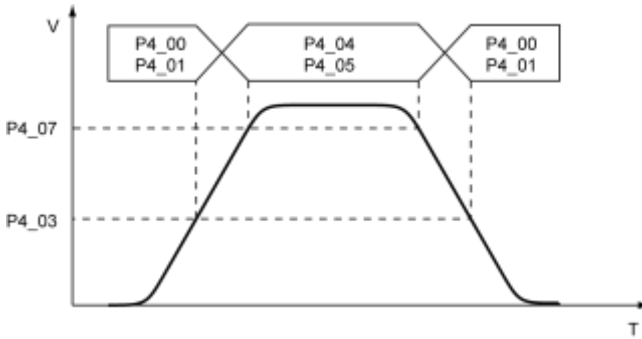



Figure 6-2 Parameters of speed loop PI

	<ul style="list-style-type: none"> <li>◆ The system's dynamic response can be faster if the proportional gain is increased or the integral time is decreased;</li> <li>◆ If the proportional gain is too large or the integral time is too small, the system will become overshoot and tend to oscillate;</li> <li>◆ Too small proportional gain may easily cause bad follow performance of the system and affect stop;</li> <li>◆ P4_02 and P4_06 are filter times of motor speed detection which need not to be adjusted, increase the values if there is current noise when motor is running.</li> </ul>
---	---

Function code	Instruction	Setting range 【default value】	Remarks
P4_08	ACR proportional coefficient P	0~65535 【2000】	Not modify in running
P4_09	ACR integral coefficient I	0~65535 【1000】	

The above parameters are related to the ACR adjustment, which directly affects the dynamic response and control accuracy if the system. In different situations, the parameters may need proper adjustment. Incorrect parameters will cause vibration to the system.

	<ul style="list-style-type: none"> <li>◆ After setting P1.16/17 to non-zero, start ACR switching function.</li> </ul>
---	---

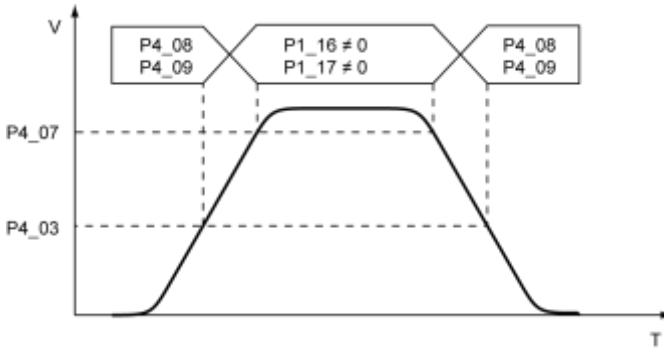



Figure 6-3 ACR switching

Function code	Instruction	Setting range 【default value】	Remarks
P4_10	ACR filter coefficient	0-65535 【3】	Not modify in running

bit0~bit2 corresponds to the running torque command filter times, the Max. value: 7 (the default value 3 means the filter time= $2^3$ /carrier frequency).  
 bit3~bit5 corresponds to the starting torque command filter times, the Max. value: 7 (the default value is 0). When the noise starts, try setting the value.

	<p>◆ The parameter is combined setting. If it is necessary to set the running torque command filter times to 2 and the starting torque command filter times to 3, the parameter=<math>2+3*8=26</math>.</p>
---	--

Function code	Instruction	Setting range 【default value】	Remarks
P4_11	Slip compensation rate of drive side	50~200% 【100】	Not modify in running
P4_12	Slip compensation rate of braking side	50~200% 【100】	

The parameter is used to adjust the slip frequency of vector control and improve the precision of speed control. Properly adjusting this parameter can effectively restrain the steady-state error.

Function code	Instruction	Setting range 【default value】	Remarks
P4_13	Torque upper limit	0.0~200.0% (rated current)	Not modify

		<b>【150.0】</b>	in running
100.0% corresponds with the rated current of inverter. For type load test, need to enlarge the parameter.			

Function code	Instruction	Setting range 【default value】	Remarks
P4_14	Load compensation enabling	0~1 <b>【1】</b>	Not modify in running
P4_15	Load compensation time	0.000~5.000s <b>【0.700】</b>	
P4_16	Reducing time of load compensation	0.000~5.000s <b>【0.300】</b>	
P4_17	ASR proportional gain	0~100 <b>【30】</b>	
P4_18	ASR integral time	0.01~10.00s <b>【0.16】</b>	
P4_19	APR proportional gain	0~100 <b>【0】</b>	
P4_20	APR integral time	0.01~10.00s <b>【0.01】</b>	
P4_21	Current compensation coefficient	-1000~4000 <b>【1500】</b>	
<p>P4_14, set to 1 and enable the function, set to 0 and disable the function;</p> <p>P4_15, start timing from running direction reference, because the non-weighing compensation function is valid at zero speed output after and before brake opening, set the parameter to zero-speed hold time;</p> <p>P4_16, the transition time from zero speed loop to low speed loop;</p> <p>P4_17 and P4_18, zero speed loop PI parameters;</p> <p>P4_19 and P4_20, generally, need no setting;</p> <p>P4_21, modifying the parameter properly can suppress vibration to the master caused by large starting compensation.</p>			

	<p>◆ Only when set P4_14 to be 1 to enable the non-weighing compensation function, P4_15, P4_16, P4_17, P4_18, P4_19, P4_20, P4_21 are valid. And P4_17, P4_18, P4_19, P4_20 and P4_21 are valid in the time set by P4_15.</p>
---	--

Function code	Instruction	Setting range 【default value】	Remarks
P4_22	Rated load (rated load of the elevator)	0~10000kG <b>【1000】</b>	Not modify in running

P4_23	Weighing input selection	0~2 【0】
<p>P4_23: Weighing input selection</p> <p>Set the signal input of LL, FL and OL.</p> <p>0: Light load, full load and overload correspond to LL, FL and OL.</p> <p>1: Select the analog input of the car. Install analog weighing sensor of DC0~10V and set after weighing autotuning.</p> <p>2: Select the analog input of the engine room. Install analog weighing sensor of DC0~10V and set after weighing autotuning.</p>		





	<ul style="list-style-type: none"> <li>◆ When LL voltage&lt;FL voltage&lt;OL voltage for the selected weighing sensor, change F0_17 Bit1 to 1 (the parameter+2);</li> <li>◆ After setting P4.23 to non-zero, F0_75, F 0_76 and F0_77, obtain the load state by setting voltage without need of load autotuning.</li> </ul>
---	--

Function code	Instruction	Setting range 【default value】	Remarks
P4_24	Weighing compensation input channel	0-2 【0】	Not modify in running
P4_25	Pre-torque bias	0.0~100.0% 【45】	
P4_26	Bias and gain at the braking side	0.000~5.000 【2.000】	
P4_27	Bias and gain at the drive side	0.000~5.000 【2.000】	
<p>The parameter is used to set the weighing compensation input channel.</p> <p>0: no compensation</p> <p>1: CAN communication. Install analog weighing sensor in the bottom of the car. Send the load signal to the main board after autotuning.</p> <p>2: terminal input. Need analog weighing signal of DC0~10V output</p> <p>P4_25 needs to be set to the voltage of the weighing sensor at the balance of the elevator correctly. For example, at the balance of the elevator, the analog input voltage in drive monitoring is 4V, and thus the parameter needs to be set to 40.0%.</p> <p>When the drive is in the electromotion state, adjust P4_26.</p> <p>When the drive is in the power generation state, adjust P4_27.</p>			

	◆ P4_25, P4_26 and P4_27 are only valid when P4_24 is set to be non-zero.
---	---

Function code	Instruction	Setting range 【default value】	Remarks
P4_28	Analog input filter of car weighing	0.00~0.50s 【0.1】	Not modify in running
P4_29	Analog input filter of engine room	0.00~0.50s 【0.1】	
P4_30	Smooth filter time of the curve	0~20ms 【6】	

**6.5.6 Parameters setting--elevator protection parameters**

<p>【main menu】</p> <p>A system control</p> <p>B fault record</p> <p>C language selection</p> <p><b>D parameters setting inquiry</b></p> <p>E password setting</p> <p>F system autotuning</p> <p>G data management</p> <p>H system information</p>	 	<p>【parameters setting inquiry】</p> <p>P0 master drive control</p> <p>P1 speed and deceleration distance</p> <p>P2 motor parameters</p> <p>P3 encoder parameters</p> <p>P4 running comfortability</p> <p><b>P5 elevator protection parameters</b></p> <p>P6 communication setting</p> <p>P7 drive information</p> <p>PE factory only</p>	 	<p>【P5 elevator protection parameters】</p> <p><b>00 Input phase loss protection</b></p> <p>01 Output phase loss protection</p> <p>02 Motor overload protection</p> <p>03 Motor overload protection current</p> <p>04 Overload pre-warning threshold</p> <p>05 Overload pre-warning selection</p> <p>06 Overload pre-warning delay time</p> <p>07 Automatic fault reset times</p> <p>08 Fault reset interval</p> <p>09 Threshold of over speed deviation</p> <p>10 Detection time of over speed deviation</p> <p>11 Braking threshold voltage</p>
---	---	--	---	--

Function code	Instruction	Setting range 【default value】	Remarks
P5_00	Input phase loss protection	0-2 【0】	Not modify in running
P5_01	Output phase loss protection	0-1 【1】	
<p>Above function codes select input/output phase loss protection enabling.</p> <p>0: Prohibit 1: Enabling 2: Only enabling in running</p>			

Function code	Instruction	Setting range 【default value】	Remarks
P5_02	Motor overload protection	0-2 【2】	Not modify in running
<p>0: Disabled 1: Normal motor. For normal motor (within the function of low speed compensation), the lower the speed, the poorer the cooling effect. Based on this reason, if output frequency is lower than 30Hz, inverter will reduce the motor overload protection threshold to prevent normal motor from overheat. 2: Variable frequency motor. For variable frequency motor (without the function of low speed compensation),As the cooling effect of variable frequency motor has nothing to do with running speed, it is not required to adjust the motor overload protection threshold.</p>			

Function code	Instruction	Setting range 【default value】	Remarks
P5_03	Motor overload protection current	20.0%~120.0% (rated current of the motor) 【100.0】	Not modify in running
<p>Motor overload protection current=(motor rated current/integrated machine rated current)*100%</p>			

	◆ This parameter is normally used when rated power of the integrated machine is greater than rated power of motor.
---	--

Function code	Instruction	Setting range 【default value】	Remarks
P5_04	Overload pre-warning threshold	20.0%~150.0% 【130.0】	Not modify in running
P5_05	Overload pre-warning selection	0-3 【0】	
P5_06	Overload pre-warning delay time	0.0~30.0s 【5.0】	

The value of P5\_04 determines the pre-warning threshold, 100% corresponds to the rated current of the integrated machine.

P5\_05: Overload pre-warning selection, determine the overload type.

0: corresponds to the rated current of the motor, detecting all the time

1: corresponds to the rated current of the motor, detecting when constant speed

2: corresponds to the rated current of the integrated machine, detecting all the time

3: corresponds to the rated current of the integrated machine, detecting when constant speed

When the output current is more than the pre-warning threshold, the system will report fault.

Function code	Instruction	Setting range 【default value】	Remarks
P5_07	Automatic fault reset times	0~3 【3】	Not modify in running
P5_08	Fault reset interval	0.1~100.0s 【10.0】	

When P5\_07 is set to non-zero, the drive fault is allowed to reset after the interval time set by P5\_08, when the time is more than P5\_07, the system will stop and need to reset after power off.

Function code	Instruction	Setting range 【default value】	Remarks
P5_09	Threshold of over speed deviation	0.1%~50.0% 【20.0】	Not modify in running
P5_10	Detection time of over speed deviation	0.000~10.000s 【0.500】	





- ◆ The speed detection is set to the rated speed of the elevator, the rated frequency of the motor and encoder feedback.



Function code	Instruction	Setting range 【default value】	Remarks
P5_11	Braking threshold voltage	320~750 【700】	Not modify in running
The 220V integrated machine should be changed into 380V.			

**6.5.7 Parameters setting---communication setting**

<p>【main menu】</p> <p>A system control</p> <p>B fault record</p> <p>C language selection</p> <p><b>D parameters setting inquiry</b></p> <p>E password setting</p> <p>F system autotuning</p> <p>G data management</p> <p>H system information</p>		<p>【parameters setting inquiry】</p> <p>P0 master drive control</p> <p>P1 speed and deceleration distance</p> <p>P2 motor parameters</p> <p>P3 encoder parameters</p> <p>P4 running comfortability</p> <p>P5 elevator protection parameters</p> <p><b>P6 communication setting</b></p> <p>P7 drive information</p> <p>PE factory only</p>		<p>【P6 communication setting】</p> <p>00 Local communication address</p> <p>01 Communication baud rate selection</p> <p>02 Data format</p> <p>03 Communication response enabling</p> <p>04 Communication response delay</p> <p>05 Communication timeout fault</p> <p>06 Reserved</p> <p>07 Reserved</p> <p>08 Ethernet communication speed setting</p> <p>09 Ethernet IP address 1</p> <p>10 Ethernet IP address 2</p> <p>11 Ethernet IP address 3</p> <p>12 Ethernet IP address 4</p> <p>13 Set the subnet mask 1</p> <p>14 Set the subnet mask 2</p> <p>15 Set the subnet mask 3</p> <p>16 Set the subnet mask 4</p>
---	---	--	---	---

Function code	Instruction	Setting range 【default value】	Remarks
P6_00	Local communication address	1~247 【1】	Not modify in running

Function code	Instruction	Setting range 【default value】	Remarks
P6_01	Communication baud rate selection	0~5 【4】	Not modify in running

This parameter is used to set the data transmission rate between the upper computer and the integrated machine.

- 0: 1200BPS                      3: 9600BPS
- 1: 2400BPS                    4: 19200BPS
- 2: 4800BPS                    5: 38400BPS

	◆ The baud rate setting of the upper computer should be the same as that of the integrated machine. The higher the baud rate, the faster the communication speed is.
---	--

Function code	Instruction	Setting range 【default value】	Remarks
P6_02	Data format	0~2 【1】	Not modify in running

The data format setting of the upper computer should be the same as that of the integrated machine. Otherwise, communication cannot be implemented.

- 0: No parity (N, 8, 1) for RTU
- 1: Even parity (E, 8, 1) for RTU
- 2: Odd parity (O, 8, 1) for RTU

Function code	Instruction	Setting range 【default value】	Remarks
P6_03	Communication response enabling	0~1 【0】	Not modify in running

- 0: Enabled
- 1: Disabled

Function code	Instruction	Setting range 【default value】	Remarks
P6_04	Communication response delay	0~20ms 【0】	Not modify in running
<p>Reply delay refers to the interval time between the end of data receiving of the machine and the reply data sending of the upper computer. If the reply delay time is less than the system processing time, take the system processing time as reply delay reference. If the reply delay is longer than the system processing time, after data processing, the system has to wait until the reply delay time is reached before sending data to the upper computer.</p>			

Function code	Instruction	Setting range 【default value】	Remarks
P6_05	Communication timeout fault	0~100.0s 【0】	Not modify in running
<p>If the functional code is set to 0.0s, the communication delay time parameter is disabled.</p> <p>When the functional code is set to be a valid value, if the interval between the current communication and the next communication exceeds the communication delay time, the system will alarm "485 communication fault" (Err118).</p> <p>Normally, it is set to be "disabled". If this parameter is set in a consecutive communication system, communication state can be monitored.</p>			



Function code	Instruction	Setting range 【default value】	Remarks
P6_08	Ethernet communication speed setting	0~4 【0】	Not modify in running
<p>0: 10M full duplex  1: 10M semi duplex  2: 100M full duplex  3: 100M semi duplex  4: Self-adaptation</p>			

Function code	Instruction	Setting range 【default value】	Remarks
P6_09~P6_12	Set Ethernet IP address	0~255 【192】	Not modify

		0~255 【168】 0~255 【5】 0~255 【60】	in running
Set Ethernet IP address. IP address: P6.09.P6.10.P6.11.P6.12 For example: IP address is 192.168.5.60			



Function code	Instruction	Setting range 【default value】	Remarks
P6_13~P6_16	Set the subnet mask	0~255 【255】 0~255 【255】 0~255 【254】 0~255 【0】	Not modify in running
Set the subnet mask of the Ethernet. The format of IP subnet mask format: P6.13.P6.14.P6.15.P6.16. For example: the subnet mask is 255.255.254.0.			

6.5.8 Parameters setting--drive information

<p>【main menu】</p> <p>A system control</p> <p>B fault record</p> <p>C language selection</p> <p><b>D parameters setting inquiry</b></p> <p>E password setting</p> <p>F system autotuning</p> <p>G data management</p> <p>H system information</p>		<p>【parameters setting inquiry】</p> <p>P0 master drive control</p> <p>P1 speed and deceleration distance</p> <p>P2 motor parameters</p> <p>P3 encoder parameters</p> <p>P4 running comfortability</p> <p>P5 elevator protection parameters</p> <p>P6 communication setting</p> <p><b>P7 drive information</b></p> <p>PE factory only</p>		<p>【P7 Drive information】</p> <p><b>00 year setting</b></p> <p>01 month/date setting</p> <p>02 hour/minute setting</p> <p>03 rectification module temperature</p> <p>04 converting module temperature</p> <p>05 DSP software version</p> <p>06 MCU software version</p> <p>07 FPGA software version</p> <p>08 software version of the car board</p> <p>09 software version of</p>
---	---	--	---	---

		the group control board 10 running time displaying 11 rated power displaying 12 rated current displaying
--	--	---

**6.5.9 Parameters setting--floor setting**



<p><b>【main menu】</b>                  A system control                  B fault record                  C language selection  <b>D parameters setting inquiry</b>                  E password setting                  F system autotuning                  G data management                  H system information</p>		<p><b>【parameters setting inquiry】</b>                  P0 master drive control                  P1 speed and deceleration distance                  P2 motor parameters                  P3 encoder parameters                  P4 running comfortability                  P5 elevator protection parameters                  P6 communication setting                  P7 drive information                  PE factory only  <b>A1 floor setting</b>                  A2 floor displaying                  H0 logic of the IO control board                  H1 logic of the car control board                  H2 front door stopping floor                  H3 rear door stopping floor</p>		<p><b>【A1 floor setting】</b>  <b>00 collective selective control mode</b>                  01 total floor setting                  02 basement setting                  03 fire landing setting                  04 park floor                  05 base floor setting                  06 door lock detection</p>
--	---	--	---	---

	H4 front/rear door stopping floor L0 parallel and group control setting	
--	--	--

Function code	Instruction	Setting range 【default value】	Remarks
A1_00	Collective selective control mode	0~2 【0】	Not modify in running
Select the calling control mode. 0: Full selective; 1: Reserved; 2: XPM (the elevator closes when holding close button in attendant state and it opens after releasing the button, generally for goods elevator)			

Function code	Instruction	Setting range 【default value】	Remarks
A1_01	Total floor setting	2~64 【16】	Not modify in running
A1_02	Basement setting	0~10 【0】	
A1_03	Fire landing setting	1~64 【1】	
A1_04	Park floor	1~64 【1】	
A1_05	Base floor setting	1~64 【1】	
A1_01 the total floor must be consistent with the number of door areas; A1_02 for parallel applications, set the elevator with basement to the main elevator; A1_03 fire landing is the destination floor during forced fire landing; A1_04 park floor is the destination floor after elevator lock becomes valid; A1_05 base floor is the destination floor when the elevator has no running request and reaches base floor delay.			

**6.5.10 Parameters setting--floor displaying setting**

<b>【main menu】</b> A system control B fault record C language selection <b>D parameters setting</b>		<b>【parameters setting inquiry】</b> P0 master drive control P1 speed and		<b>【A2 floor displaying】</b> 1 floor displaying 2 floor displaying 3 floor displaying 4 floor displaying
---	---	--	---	--

inquiry		
E password setting	deceleration distance	5 floor displaying
F system autotuning	P2 motor parameters	6 floor displaying
G data management	P3 encoder parameters	7 floor displaying
H system information	P4 running comfortability	8 floor displaying
	P5 elevator protection parameters	9 floor displaying
	P6 communication setting	.
	P7 drive information	.
	PE factory only	.
	A1 floor setting	64 floor displaying
	<b>A2 floor displaying</b>	
	H0 logic of the IO control board	
	H1 logic of the car control board	
	H2 front door stopping floor	
	H3 rear door stopping floor	
	H4 front/ rear door stopping floor	
	L0 parallel and group control setting	

Function code	Instruction	Setting range 【default value】	Remarks
A2_00	1 floor displaying	0~9090 【1617】	Not modify in running
A2_01	2 floor displaying	0~9090 【1618】	
A2_02	3 floor displaying	0~9090 【1619】	
A2_03	4 floor displaying	0~9090 【1620】	
A2_04	5 floor displaying	0~9090 【1621】	
A2_05	6 floor displaying	0~9090 【1622】	

Function code	Instruction	Setting range 【default value】	Remarks
A2_06	7 floor displaying	0~9090 【1623】	
A2_07	8 floor displaying	0~9090 【1624】	
A2_08	9 floor displaying	0~9090 【1625】	
A2_09	10 floor displaying	0~9090 【1716】	
A2_10	11 floor displaying	0~9090 【1717】	
A2_11	12 floor displaying	0~9090 【1718】	
A2_12	13 floor displaying	0~9090 【1719】	
A2_13	14 floor displaying	0~9090 【1720】	
A2_14	15 floor displaying	0~9090 【1721】	
A2_15	16 floor displaying	0~9090 【1722】	
A2_16	17 floor displaying	0~9090 【1723】	
A2_17	18 floor displaying	0~9090 【1724】	
A2_18	19 floor displaying	0~9090 【1725】	
A2_19	20 floor displaying	0~9090 【1816】	
A2_20	21 floor displaying	0~9090 【1817】	
A2_21	22 floor displaying	0~9090 【1818】	
A2_22	23 floor displaying	0~9090 【1819】	
A2_23	24 floor displaying	0~9090 【1820】	
A2_24	25 floor displaying	0~9090 【1821】	
A2_25	26 floor displaying	0~9090 【1822】	
A2_26	27 floor displaying	0~9090 【1823】	
A2_27	28 floor displaying	0~9090 【1824】	
A2_28	29 floor displaying	0~9090 【1825】	
A2_29	30 floor displaying	0~9090 【1916】	
A2_30	31 floor displaying	0~9090 【1917】	
A2_31	32 floor displaying	0~9090 【1918】	
A2_32	33 floor displaying	0~9090 【1919】	
A2_33	34 floor displaying	0~9090 【1920】	
A2_34	35 floor displaying	0~9090 【1921】	
A2_35	36 floor displaying	0~9090 【1922】	
A2_36	37 floor displaying	0~9090 【1923】	





Function code	Instruction	Setting range 【default value】	Remarks
A2_37	38 floor displaying	0~9090 【1924】	
A2_38	39 floor displaying	0~9090 【1925】	
A2_39	40 floor displaying	0~9090 【2016】	
A2_40	41 floor displaying	0~9090 【2017】	
A2_41	42 floor displaying	0~9090 【2018】	
A2_42	43 floor displaying	0~9090 【2019】	
A2_43	44 floor displaying	0~9090 【2020】	
A2_44	45 floor displaying	0~9090 【2021】	
A2_45	46 floor displaying	0~9090 【2022】	
A2_46	47 floor displaying	0~9090 【2023】	
A2_47	48 floor displaying	0~9090 【2024】	
A2_48	49 floor displaying	0~9090 【2025】	
A2_49	50 floor displaying	0~9090 【2116】	
A2_50	51 floor displaying	0~9090 【2117】	
A2_51	52 floor displaying	0~9090 【2118】	
A2_52	53 floor displaying	0~9090 【2119】	
A2_53	54 floor displaying	0~9090 【2120】	
A2_54	55 floor displaying	0~9090 【2121】	
A2_55	56 floor displaying	0~9090 【2122】	
A2_56	57 floor displaying	0~9090 【2123】	
A2_57	58 floor displaying	0~9090 【2124】	
A2_58	59 floor displaying	0~9090 【2125】	
A2_59	60 floor displaying	0~9090 【2216】	
A2_60	61 floor displaying	0~9090 【2217】	
A2_61	62 floor displaying	0~9090 【2218】	
A2_62	63 floor displaying	0~9090 【2219】	
A2_63	64 floor displaying	0~9090 【2220】	

The above parameters can be set according to the following corresponding table of floor displaying.

Setting value	00	01	02	03	04	05	06	07	08	09	10	11	12	13	14	15
Displaying		!	"	#	\$	%	&	'	( )	*	+	,	-	.	/	
Setting value	16	17	18	19	20	21	22	23	24	25	26	27	28	29	30	31
Displaying	0	1	2	3	4	5	6	7	8	9	:	;	<	=	>	?
Setting value	32	33	34	35	36	37	38	39	40	41	42	43	44	45	46	47
Displaying	@	A	B	C	D	E	F	G	H	I	J	K	L	M	N	O
Setting value	48	49	50	51	52	53	54	55	56	57	58	59	60	61	62	63
Displaying	P	Q	R	S	T	U	V	W	X	Y	Z	[	\	]	^	_
Setting value	64	65	66	67	68	69	70	71	72	73	74	75	76	77	78	79
Displaying	`	a	b	c	d	e	f	g	h	i	j	k	l	m	n	o
Setting value	80	81	82	83	84	85	86	87	88	89	90	Floor displaying				
Displaying	p	q	r	s	t	u	v	w	x	y	z	Corresponding table				

6.5.11 Parameters setting--logic setting of I/O control board

<p><b>【main menu】</b></p> <p>A system control</p> <p>B fault record</p> <p>C language selection</p> <p><b>D parameters setting inquiry</b></p> <p>E password setting</p> <p>F system autotuning</p> <p>G data management</p> <p>H system information</p>		<p><b>【parameters setting inquiry】</b></p> <p>P0 master drive control</p> <p>P1 speed and deceleration distance</p> <p>P2 motor parameters</p> <p>P3 encoder parameters</p> <p>P4 running comfortability</p> <p>P5 elevator protection parameters</p> <p>P6 communication setting</p> <p>P7 drive information</p> <p>PE factory only</p> <p>A1 floor setting</p> <p>A2 floor displaying</p> <p><b>H0 logic of the IO control board</b></p> <p>H1 logic of the car control board</p> <p>H2 front door stopping floor</p>		<p><b>【H0 logic of the IO control board】</b></p> <p>00 logic setting 1</p> <p>01 logic setting 2</p> <p>02 logic setting 3</p> <p>03 logic setting 4</p> <p>04 logic setting 5</p> <p>05 logic setting 6</p> <p>06 I/O control board logic setting</p> <p>07 reserved</p> <p>08 reserved</p>
--	---	---	---	--



H3 rear door stopping floor  
 H4 front/ rear door  
 stopping floor  
 L0 parallel and group  
 control setting



Logic setting 1 is the logic setting of the following signals:

Terminal	P8	P7	P6	P5	P4	P3	P2	P1
Definition	Up limit	Down limit	High speed up forced deceleration signal	High speed down forced deceleration signal	Medium speed up forced deceleration signal	Medium speed down forced deceleration signal	Low speed up forced deceleration signal	Low speed down forced deceleration signal
NO/NC	●	●	●	●	●	●	●	●
Binary	1	1	1	1	1	1	1	1
Decimal	1×128	1×64	1×32	1×16	1×8	1×4	1×2	1×1
H0_00 Logic setting 1	128+64+32+16+8+4+2+1=255							

1 to 8 (from low bit to high bit) are shown in binary numbers. The corresponding bit of NO points set to be 0 and the NC to be 1. Write the convertering decimal result to logic 1.

Above switches are NC, which can be shown in binary 11111111, converted into decimal (1+2+4+8+16+32+64+128)=255.

Logic setting 2 is the logic setting of the following signals:

Terminal	P16	P15	P14	P13	P12	P11	P10	P9
Definition	Safety contactor detection	Middle door area	Down door area	Up door area	Inspection down signal	Inspection up signal	Inspection signal	Emergency electric running
NO/NC	○	○	○	○	○	○	●	●
Binary	0	0	0	0	0	0	1	1
Decimal	0×128	0×64	0×32	0×16	0×8	0×4	1×2	1×1
H0_01 Logic setting 2	2+1=3							

9 to 16 (from low bit to high bit) are shown in binary numbers. The corresponding bit of NO points

set to be 0 and the NC to be 1. Write the convertering decimal result to logic 2.

Above switches 9 and 10 are NC, and others are NO, which can be shown in binary 00000011, converted into decimal  $(1+2)=003$ .

Logic setting 3 is the logic setting of the following signals:

Terminal	P24	P23	P22	P21	P20	P19	P18	P17
Definition	Safety high voltage detection	UPS input signal	Fire action signal	Motor thermal protection	Brake travel switch detection	Brake contactor detection	Output contactor detection	Door lock contactor detection
NO/NC	○	○	○	○	●	●	●	○
Binary	0	0	0	0	1	1	1	0
Decimal	0x128	0x64	0x32	0x16	1x8	1x4	1x2	0x1
H0_02 Logic setting 3	8+4+2=14							

17 to 24 (from low bit to high bit) are shown in binary numbers. The corresponding bit of NO points set to be 0 and the NC to be 1. Write the convertering decimal result to logic 3.

Above switches 18-20 are NC, and others are NO, which can be shown in binary 00001110, converted into decimal  $(2+4+8)=014$ .



Logic setting 4 is the logic setting of the following signals:

Terminal	P32	P31	P30	P29	P28	P27	P26	P25
Definition	Self-definition input 3	Self-definition input 2	Self-definition input 1	Pre-opening adhesion	Pre-opening feedback	Hardware enabling	Hall door lock high voltage detection	Car door lock high voltage detection
NO/NC	○	○	○	○	○	○	○	○
Binary	0	0	0	0	0	0	0	0
Decimal	0x128	0x64	0x32	0x16	0x8	0x4	0x2	0x1
H0_03 Logic setting 4	0							



25 to 32 (from low bit to high bit) are shown in binary numbers. The corresponding bit of NO points set to be 0 and the NC to be 1. Write the convertering decimal result to logic 1.

Above input are NO, which can be shown in binary 00000000, converted into decimal 000.

The single logic setting of I/O board is the logic setting of each point on I/O board. It can be modified associated with logic setting 1-6:

<p>【H0 IO I/O control board logic setting】</p> <p>00 logic setting 1</p> <p>01 logic setting 2</p> <p>02 logic setting 3</p> <p>03 logic setting 4</p> <p>04 logic setting 5</p> <p>05 logic setting 6</p> <p><b>06 logic setting of I/O control board</b></p> <p>07 reserved</p> <p>08 reserved</p>		<p>【input signal 1-32】</p> <p>1 low speed down forced speed changing</p> <p>2 low speed down forced speed changing</p> <p>3 low speed down forced speed changing</p> <p>4 low speed down forced speed changing</p> <p>5 low speed down forced speed changing</p> <p>6 low speed down forced speed changing</p> <p>7 down limit</p> <p>8 up limit</p> <p>9 emergency electric running</p>		<p>1 low speed down forced speed changing I/O input signal logic setting</p> <p>Current value: 1</p> <p>Setting: <b>1</b></p> <p>【parameters instruction】</p> <p>0: NO</p> <p>1: NC</p>
--	---	--	---	---

**6.5.12 Parameters setting---logic setting of car control board**

<p>【main menu】</p> <p>A system control</p> <p>B fault record</p> <p>C language selection</p> <p><b>D parameters setting inquiry</b></p> <p>E password setting</p> <p>F system autotuning</p> <p>G data management</p> <p>H system information</p>		<p>【parameters setting inquiry】</p> <p>P0 master drive control</p> <p>P1 speed and deceleration distance</p> <p>P2 motor parameters</p> <p>P3 encoder parameters</p> <p>P4 running comfortability</p> <p>P5 elevator protection parameters</p> <p>P6 communication setting</p> <p>P7 drive information</p> <p>PE factory only</p>		<p>【H1 logic of the car control board】</p> <p>00 car logic setting 1</p> <p>01 car logic setting 2</p> <p>02 car logic setting 3</p> <p>03 car logic setting 4</p> <p>04 single logic setting of the car</p> <p>05 reserved</p> <p>06 reserved</p> <p>07 reserved</p> <p>08 reserved</p>
---	---	---	---	--

	A1 floor setting A2 floor displaying H0 logic of the IO control board <b>H1 logic of the car control board</b> H2 front door stopping floor H3 rear door stopping floor H4 front/ rear door stopping floor L0 parallel and group control setting	
--	---	--

Logic setting 1 is the logic setting of below signal points:

Terminal	C8	C7	C6	C5	C4	C3	C2	C1
Definition	Safety edge	Closing input signal	Opening input signal	Door closed	Door open	OL	DD	Attendant
NO/NC	●	○	○	●	●	○	○	○
Binary	1	0	0	1	1	0	0	0
Decimal	1×128	0×64	0×32	1×16	1×8	0×4	0×2	0×1
H1_00 Logic setting 1	128+16+8=152							

Input point 1 to 8 (from low bit to high bit) are shown in binary numbers. The corresponding bit of NO points set to be 0 and the NC to be 1. Write the convertering decimal result to logic 1.

The parameter is set to 004 if the OL switch is NC.

The parameter is set to (16+8)=24 if the Door closed/open is NC.

The parameter is set to 128 if the front door beam is NC.

The parameter is set to (8+16+128)=152, if the OL, door closed/open and beam are NC and others are NO.

Logic setting 2 is the logic setting of below signal points:

Terminal	C16	C15	C14	C13	C12	C11	C10	C9
Definition	Closing button for fire fighters	Rear door closed	Rear door open	Independent running	Front/rear door switching	Beam	FL	LL
NO/NC	o	o	o	o	o	o	o	o
Binary	0	0	0	0	0	0	0	0
Decimal	0x128	0x64	0x32	0x16	0x8	0x4	0x2	0x1
H1_01 Logic setting 2	0							

The single logic setting of car is the logic setting of each point of main controller in car. It can be modified associated with logic setting 1-4:

**【H1 logic of the car control board】**

00 car logic setting 1

01 car logic setting 2

02 car logic setting 3

03 car logic setting 4

**04 single logic setting of the car**

05 reserved

06 reserved

07 reserved

08 reserved



**【input signal1-32:】**

**1 Attendant**

2 DD

3 OL

4 door open

5 door closed

6 opening button

7 closing button

8 safety edge

9 LL



1 Attendant

Logic setting of the car input signal

Current value: 1

Setting: **1**

**【parameters instruction】**

0: NO

1: NC

### 6.5.13 Parameters setting--front door stopping floor

**【main menu】**

A system control

B fault record

C language selection

**D parameters setting inquiry**

E password setting



**【parameters setting inquiry】**

P0 master drive control

P1 speed and deceleration distance

P2 motor parameters

P3 encoder parameters

P4 running



**【H2 front door stopping floor】**

00 front door stopping floor enabling 1

01 front door stopping floor enabling 2

02 front door stopping floor enabling 3

F system autotuning	comfortability	03 front door stopping
G data management	P5 elevator protection parameters	floor enabling 4
H system information	P6 communication setting	04 front door stopping floor enabling 5
	P7 drive information	05 front door stopping floor enabling 6
	PE factory only	06 front door stopping floor enabling 7
	A1 floor setting	07 front door stopping floor enabling 8
	A2 floor displaying	08 set opening at stop according to floors
	H0 logic of the IO control board	
	H1 logic of the car control board	
	<b>H2 front door stopping floor</b>	
	H3 rear door stopping floor	
	H4 front/ rear door stopping floor	
	L0 parallel and group control setting	

Function code	Instruction	Setting range 【default value】	Remarks
H2_00	Front door 1~8 floor	000~255 【255】	Not modify in running
H2_01	Front door 9~16 floor	000~255 【255】	
H2_02	Front door 17~24 floor	000~255 【255】	
H2_03	Front door 25~32 floor	000~255 【255】	
H2_04	Front door 33~40 floor	000~255 【255】	
H2_05	Front door 41~48 floor	000~255 【255】	
H2_06	Front door 49~56 floor	000~255 【255】	
H2_07	Front door 57~64 floor	000~255 【255】	



Set the front door stopping floor which is shown by binary numbers.



1: valid

0: invalid

For example, if the elevator stops at 1, 3, 6, and 8 floor and does not stop at other floors, then  $H2\_00=(1+4+32+128)=165$ . see the figure below for detailed calculation:

【H2_00 1-8 stopping floor】	NO	NC	【H2_00 1-8 stopping floor】	NO	NC
1 floor	0	1	5 floor	0	16
2 floor	0	2	6 floor	0	32
3 floor	0	4	7 floor	0	64
4 floor	0	8	8 floor	0	128

The menu and method for setting closing/opening of the elevator:

<p>【H2 front door stopping floor】</p> <p>00 front door stopping floor enabling 1</p> <p>01 front door stopping floor enabling 2</p> <p>02 front door stopping floor enabling 3</p> <p>03 front door stopping floor enabling 4</p> <p>04 front door stopping floor enabling 5</p> <p>05 front door stopping floor enabling 6</p> <p>06 front door stopping floor enabling 7</p> <p>07 front door stopping floor enabling 8</p> <p><b>08 Set opening at stop according to floors</b></p>		<p>【closing/opening enabling】</p> <p><b>01 floor closing/opening enabling</b></p> <p>02 floor closing/opening enabling</p> <p>03 floor closing/opening enabling</p> <p>.....</p> <p>61 floor closing/opening enabling</p> <p>62 floor closing/opening enabling</p> <p>63 floor closing/opening enabling</p>		<p>01 floor closing/opening enabling</p> <p>Current value: 01</p> <p>Setting: <b>01</b></p> <p>[Instruction of parameters]</p> <p>0: Not stop</p> <p>1: Open the front door</p> <p>2: Open the rear door</p> <p>3: Calling decides to close/open the door</p> <p>7: The front and rear doors close/open simultaneously.</p>
--	---	---	---	---

After entering the menu, set the doors of 1~63 floors respectively. Set the parameter to 0 for passing without stop, 1 for opening the front door, 2 for opening the rear door, 3 for opening the door according to calling of front and rear doors or calling signals of control box, and 7 for

closing/opening the front and rear doors simultaneously.

**6.5.14 Parameters setting---rear door stopping floor**

<p><b>【main menu】</b></p> <p>A system control</p> <p>B fault record</p> <p>C language selection</p> <p><b>D parameters setting inquiry</b></p> <p>E password setting</p> <p>F system autotuning</p> <p>G data management</p> <p>H system information</p>		<p><b>【parameters setting inquiry】</b></p> <p>P0 master drive control</p> <p>P1 speed and deceleration distance</p> <p>P2 motor parameters</p> <p>P3 encoder parameters</p> <p>P4 running comfortability</p> <p>P5 elevator protection parameters</p> <p>P6 communication setting</p> <p>P7 drive information</p> <p>PE factory only</p> <p>A1 floor setting</p> <p>A2 floor displaying</p> <p>H0 logic of the IO control board</p> <p>H1 logic of the car control board</p> <p>H2 front door stopping floor</p> <p><b>H3 rear door stopping floor</b></p> <p>H4 front/ rear door stopping floor</p> <p>L0 parallel and group control setting</p>		<p><b>【H3 rear door stopping floor】</b></p> <p>00 rear door stopping floor enabling 1</p> <p>01 rear door stopping floor enabling 2</p> <p>02 rear door stopping floor enabling 3</p> <p>03 rear door stopping floor enabling 4</p> <p>04 rear door stopping floor enabling 5</p> <p>05 rear door stopping floor enabling 6</p> <p>06 rear door stopping floor enabling 7</p> <p>07 rear door stopping floor enabling 8</p> <p>08 reserved</p>
--	---	---	---	--

Function code	Instruction	Setting range 【default value】	Remarks
H3_00	Rear door 1~8 floor	000~255 【0】	Not modify in running
H3_01	Rear door 9~16 floor	000~255 【0】	
H3_02	Rear door 17~24 floor	000~255 【0】	
H3_03	Rear door 25~32 floor	000~255 【0】	
H3_04	Rear door 33~40 floor	000~255 【0】	
H3_05	Rear door 41~48 floor	000~255 【0】	
H3_06	Rear door 49~56 floor	000~255 【0】	
H3_07	Rear door 57~64 floor	000~255 【0】	
H3_08	Reserved		
Set the rear door stopping floor with the same method mentioned above.			



**6.5.15 Parameters setting--front/rear door stopping floor**

<p>【main menu】</p> <p>A system control</p> <p>B fault record</p> <p>C language selection</p> <p><b>D parameters setting inquiry</b></p> <p>E password setting</p> <p>F system autotuning</p> <p>G data management</p> <p>H system information</p>		<p>【parameters setting inquiry】</p> <p>P0 master drive control</p> <p>P1 speed and deceleration distance</p> <p>P2 motor parameters</p> <p>P3 encoder parameters</p> <p>P4 running comfortability</p> <p>P5 elevator protection parameters</p> <p>P6 communication setting</p> <p>P7 drive information</p> <p>PE factory only</p> <p>A1 floor setting</p> <p>A2 floor displaying</p> <p>H0 logic of the IO control board</p>		<p>【H4 front/rear door stopping floor】</p> <p>00 front/rear door stopping floor enabling1</p> <p>01 front/rear door stopping floor enabling2</p> <p>02 front/rear door stopping floor enabling3</p> <p>03 front/rear door stopping floor enabling4</p> <p>04 front/rear door stopping floor enabling5</p> <p>05 front/rear door stopping floor enabling6</p> <p>06 front/rear door stopping floor enabling7</p> <p>07 front/rear door stopping floor enabling8</p> <p>08 reserved</p>
---	---	--	---	---

	H1 logic of the car control board H2 front door stopping floor H3 rear door stopping floor <b>H4 front/ rear door stopping floor</b> L0 parallel and group control setting	
--	--	--

Function code	Instruction	Setting range 【default value】	Remarks
H4_00	Front/rear door 1~8 floor	000~255 【0】	Not modify in running
H4_01	Front/rear door 9~16 floor	000~255 【0】	
H4_02	Front/rear door 17~24 floor	000~255 【0】	
H4_03	Front/rear door 25~32 floor	000~255 【0】	
H4_04	Front/rear door 33~40 floor	000~255 【0】	
H4_05	Front/rear door 41~48 floor	000~255 【0】	
H4_06	Front/rear door 49~56 floor	000~255 【0】	
H4_07	Front/rear door 57~64 floor	000~255 【0】	
H4_08	Reserved		
Set the front/rear door stopping floor with the same method mentioned above.			

**6.5.16 Parameters setting--parallel and group control setting**

<p>【main menu】</p> A system control B fault record C language selection <b>D parameters setting inquiry</b> E password setting F system autotuning G data management H system information		<p>【parameters setting inquiry】</p> P0 master drive control P1 speed and deceleration distance P2 motor parameters P3 encoder parameters P4 running		<p>【L0 parallel and group control setting】</p> 00 Group number of the elevator 01 Up bias floor 02 Down bias floor 03 Parallel home floor
--	---	---	---	--



	comfortability P5 elevator protection parameters P6 communication setting P7 drive information PE factory only A1 floor setting A2 floor displaying H0 logic of the IO control board H1 logic of the car control board H2 front door stopping floor H3 rear door stopping floor H4 front/ rear door stopping floor L0 parallel and group control setting	
--	--	--

Function code	Instruction	Setting range 【default value】	Remarks
L0_00	Group number of the elevator	0~10 【0】	Not modify in running
L0_01	Up bias floor	0~64 【0】	
L0_02	Down bias floor	0~64 【0】	
L0_03	Parallel home floor	0~64 【0】	
Set the parallel or group control parameters. L0_00: 0: single elevator 1: parallel main elevator 2: parallel sub elevator 3 and above: group control L0_01, L0_02 and L0_03 are needed in the parallel applications.			

 <b>Caution</b>	◆ When there is only up bias for parallel elevators, set the up bias to main
--	--

	<p>elevator and pass the floors above the top floor of sub elevator without stop.</p> <p>◆ When there is only down bias for parallel elevators, set the down bias to main elevator. Simultaneously, if there is up bias, set the top floor or above of lower floors to non-stop.</p>
--	--

**6.5.17 Parameters setting--time setting**

<p><b>【main menu】</b></p> <p>A system control</p> <p>B fault record</p> <p>C language selection</p> <p><b>D parameters setting inquiry</b></p> <p>E password setting</p> <p>F system autotuning</p> <p>G data management</p> <p>H system information</p>		<p><b>【parameters setting inquiry】</b></p> <p>P0 master drive control</p> <p>P1 speed and deceleration distance</p> <p>P2 motor parameters</p> <p>P3 encoder parameters</p> <p>P4 running comfortability</p> <p>P5 elevator protection parameters</p> <p>P6 communication setting</p> <p>P7 drive information PE factory only</p> <p>A1 floor setting</p> <p>A2 floor displaying</p> <p>H0 logic of the IO control board</p> <p>H1 logic of the car control board</p> <p>H2 front door stopping floor</p> <p>H3 rear door stopping floor</p> <p>H4 front/ rear door</p>		<p><b>【T0 time setting】</b></p> <p><b>00 Open delay</b></p> <p>01 Reserved</p> <p>02 Return to the home floor delay</p> <p>03 Free energy-saving delay</p> <p>04 Brake opening delay</p> <p>05 Brake closing delay</p> <p>06 Starting shake prevention delay</p> <p>07 Direction cancel delay</p> <p>08 Inspection stopping delay</p> <p>09 Fire running delay</p> <p>10 Arrival gong delay</p> <p>11 Thermal protection reset delay</p> <p>12 Pre-opening delay</p> <p>13 Peristaltic landing overtime</p> <p>14 Speed reference delay</p> <p>15 Braking voltage shifting delay</p> <p>16 Keeping time of opening delay</p>
--	---	---	---	--

	stopping floor L0 parallel and group control setting <b>T0 time setting</b> F0 function setting U0 calling signal U1 system monitoring U2 hoistway information	17 Entire running protection time 18 Single floor running protection time
--	--	--

Function code	Instruction	Setting range 【default value】	Remarks
T0_00	Open delay	0~500s 【3】	Not modify in running
T0_00 sets the time from door open to automatic closing.			

Function code	Instruction	Setting range 【default value】	Remarks
T0_02	Return to the home floor delay	0~5000s 【120】	Not modify in running
T0_02 sets the time from the free elevator to returning to the home floor.			

Function code	Instruction	Setting range 【default value】	Remarks
T0_03	Free energy-saving delay	0~5000s 【60】	Not modify in running
T0_03 sets the time from free elevator to entering into the energy-saving state.			

Function code	Instruction	Setting range 【default value】	Remarks
T0_04	Brake opening delay	0~5.000s 【0.2】	Not modify in running
T0_05	Brake closing delay	0~5.000s 【0.4】	
T0_04: the time from running direction reference to the output brake			
T0_05: the time from speed cancel to the brake cancel			

Function code	Instruction	Setting range 【default value】	Remarks
T0_06	Starting shake prevention delay	0~5.000s 【0.3】	Not modify in running
T0_06 sets the time from lock connection to the running contactor output.			

 <b>Caution</b>	◆ Adjust the parameter when the door shakes when door closed.
--	---

Function code	Instruction	Setting range 【default value】	Remarks
T0_07	Direction cancel delay	0~5.000s 【0.2】	Not modify in running
T0_07 sets the time from detecting brake travel switch feedback after closing brake output to canceling direction.			

 <b>Caution</b>	◆ Adjust the parameter when the brake travel switch is not sensitive.
--	---

Function code	Instruction	Setting range 【default value】	Remarks
T0_08	Inspection stopping delay	0~5.000s 【0.300】	Not modify in running
Set the time from brake cancel to direction cancel in inspection state. Increase the parameter when the brake travel switch is not connected.			

 <b>Caution</b>	◆ Valid when the parameter is more than or equal to 0.300, otherwise the brake and speed will cancel in inspection stopping.
--	--

Function code	Instruction	Setting range 【default value】	Remarks
T0_09	Fire running delay	0~5.000s 【0.000】	Not modify in running
Set the time from elevator forced stop to the fire floor entering into the fire state.			



Function code	Instruction	Setting range 【default value】	Remarks
T0_10	Arrival gong delay	0~5.000s 【0.000】	Not modify in running
Set the time from the arrival gong output to canceling the arrival gong.			

Function code	Instruction	Setting range 【default value】	Remarks
T0_11	Thermal protection reset delay	0~5000s 【600】	Not modify in running
Set the time from thermal protection switch reset to rerunning of the elevator.			

Function code	Instruction	Setting range 【default value】	Remarks
T0_12	Pre-opening delay	0~5.000s 【0.000】	Not modify in running
T0_13	Peristaltic landing overtime	0~5.000s 【0】	
Set the pre-opening delay. When satisfying pre-opening and short circuiting door lock, delay opening. And set it to 0 to cancel the function.			
Set the protection time of peristaltic landing running (coordinate with peristaltic landing speed) and set it to 0 to cancel the function.			

 <b>Caution</b>	◆ After T0_12 or T0_13 is set, Y5 will be forced as low speed signal output.
---	--

Function code	Instruction	Setting range 【default value】	Remarks
T0_14	Speed reference delay	0~5.000s 【0.500】	Not modify in running
Set the time from the brake output and receiving the feedback to the reference speed.			

Function code	Instruction	Setting range 【default value】	Remarks
T0_15	Braking voltage shifting delay	0~5.000s 【0.000】	Not modify in running

The time from output brake to braking shifting.

Function code	Instruction	Setting range 【default value】	Remarks
T0_16	Keeping time of opening delay	0~500.0s 【30.0】	Not modify in running
Press the opening delay button, and the system will close the door automatically after the set time. Press closing button can close the door in advance.			

	<ul style="list-style-type: none"> <li>◆ Enable the function after parameter setting. The parameters are forced to adjust automatically as follows: F0_07=1, DOD in the car (same as IND) for the opening delay button; F0_15=1x, DOD at the car top for the opening delay light.</li> </ul>
---	--



Function code	Instruction	Setting range 【default value】	Remarks
T0_17	Entire running protection time	0~100s 【45】	Not modify in running
This parameter is used to limit the running time of the motor. The elevator will stop immediately when the time is arrived.			

Function code	Instruction	Setting range 【default value】	Remarks
T0_18	Single floor running protection time	0~100s 【45】	Not modify in running
This parameter is used to set the single floor running protection time for the higher floors.			

Function code	Instruction	Setting range 【default value】	Remarks
T0_19	Fast arrival opening delay	0~65535 【0】	Not modify in running
This parameter is the time from switching on output to opening output at stop of the elevator, unit: 100ms. Generally, it does not need setting.			

Function code	Instruction	Setting range 【default value】	Remarks
T0_20	Beam keeping failure time	0~65535s 【0】	Not modify in running
When the elevator stops after fast arrival at the door area and opens the door, after the continuous action time of the beam reaches the set value, the door can be closed manually.			

6.5.18 Parameters setting--function setting

<p><b>【 main menu 】</b></p> <p>A system control</p> <p>B fault record</p> <p>C language selection</p> <p><b>D parameters setting inquiry</b></p> <p>E password setting</p> <p>F system autotuning</p> <p>G data management</p> <p>H system information</p>		<p><b>【 parameters setting inquiry 】</b></p> <p>P0 master drive control</p> <p>P1 speed and deceleration distance</p> <p>P2 motor parameters</p> <p>P3 encoder parameters</p> <p>P4 running comfortability</p> <p>P5 elevator protection parameters</p> <p>P6 communication setting</p> <p>P7 drive information</p> <p>PE factory only</p> <p>A0 reserved</p> <p>A1 floor setting</p> <p>A2 floor displaying</p> <p>H0 logic of the IO control board</p> <p>H1 logic of the car control board</p> <p>H2 front door stopping floor</p> <p>H3 rear door stopping</p>		<p><b>【 F0 function setting 】</b></p> <p><b>00 High/low voltage detection</b></p> <p>01 Hand door enabling</p> <p>02 Closing output delay</p> <p>03 Fire safety mode</p> <p>04 Closing output condition of dual doors</p> <p>05 Floor opening mode of parallel outside calling</p> <p>06 Reset mode of running fault overtime</p> <p>07 MF definition of IND</p> <p>08 Internal command limit times</p> <p>09 Dual door control mode</p> <p>10 Output landing of fire forced landing</p> <p>11 Floor internal command opening enabling</p> <p>12 LIN1 multi-function definition</p> <p>13 LIN2 multi-function definition</p> <p>14 LIN3 multi-function definition</p> <p>15 MF output in the car</p>
--	---	--	---	--

	floor H4 front/ rear door stopping floor L0 parallel and group control setting T0 time setting <b>F0 function setting</b> U0 calling signal U1 system monitoring U2 hoistway information	16 test mode 17 relative selection of CAN communication 18 relative selection of elevator running 19 1387 encoder C/D sampling 20 filter coefficient of stop curve 21 peristaltic landing distance 22 UPS application 57 front door IC open floor1 58 front door IC open floor2 ..... 98 reserved
--	--	--

Function code	Instruction	Setting range 【default value】	Remarks
F0_00	High/low voltage detection	0~2 【2】	Not modify in running
Select for the safety circuit, hall lock and car lock circuit. 0: only detect high voltage, detect the BJ4 terminal 1: only detect low voltage, detect the 1KSAF and 1KDL in AJ2 2: detect high/low voltage			

Function code	Instruction	Setting range 【default value】	Remarks
F0_01	Hand door enabling	0~1 【0】	Not modify in running
0: invalid 1: arrival without open/closed detection. The elevator continues to run after switch off the door lock.			

	<ul style="list-style-type: none"> <li>◆ If energy saving is necessary in the state, set the closed signal to normally closed attribute.</li> </ul>
---	---

Function code	Instruction	Setting range 【default value】	Remarks
F0_02	Closing output delay	0~600.0s 【0.5】	Not modify in running
0: do not output closing signal after the door is closed 0.1-600.0 is the closing keeping time after the door is closed (after setting it to 600s, keep closed)			

Function code	Instruction	Setting range 【default value】	Remarks
F0_03	Fire safety mode	0~3 【0】	Not modify in running
0: China fire safety 1: Australia fire safety 2: Britain fire safety 3: Special function for fire safety 2012			

	<ul style="list-style-type: none"> <li>◆ Britain fire safety is also applicable in Hongkong. Enter the fire safety mode by IND.</li> <li>◆ As for special function for fire safety 2012, output alarm and low speed opening by Y5 and Y6, or output by F0_15 mapping onto car board DOD and PAS light.</li> </ul>
---	---

Function code	Instruction	Setting range 【default value】	Remarks
F0_04	Closing output condition of dual doors	0~1 【0】	Not modify in running
0: dual door output closing signal when the door lock is blocked 1: end the closing command after the door closed			

	<ul style="list-style-type: none"> <li>◆ Set F0-02 to non-zero when selecting dual door output closing signal.</li> <li>◆ F0-02 closing output delay when selecting to end the closing command after the door closed.</li> </ul>
---	--

Function code	Instruction	Setting range 【default value】	Remarks
F0_05	Floor opening mode of parallel outside calling	0~2 【0】	Not modify in running
0: main and sub elevator opening at the same time 1: main elevator opening 2: sub elevator opening			

Function code	Instruction	Setting range 【default value】	Remarks
F0_06	Reset mode of running fault overtime	0~1 【0】	Not modify in running
0: manual reset 1: returning to leveling automatically			

Function code	Instruction	Setting range 【default value】	Remarks
F0_07	MF definition of IND	0~3 【1】	Not modify in running
0: original definition 1: keep opening delay 2: select front/rear door 3: fire fighter input			

Function code	Instruction	Setting range 【default value】	Remarks
F0_08	Internal command limit times	0~5 【0】	Not modify in running
0: without LL function 1-5: record signal times limit when LL			

Function code	Instruction	Setting range 【default value】	Remarks
F0_09	Dual door control mode	0~1 【1】	Not modify in running
0: dual control box mode 1: single control box mode			

	◆ Set car logic to 3 when selecting dual control box mode. (Refer to the set value of car logic1.)
---	--

Function code	Instruction	Setting range 【default value】	Remarks
F0_10	Output landing of fire forced landing	0~1 【0】	Not modify in running
0: output after forced landing 1: output only in the home floor after forced landing			

Function code	Instruction	Setting range 【default value】	Remarks
F0_11	Floor internal command opening enabling	0~1 【0】	Not modify in running
0: disabled 1: enabled (applicable to IC card or no open button)			

Function code	Instruction	Setting range 【default value】	Remarks
F0_12	LINE1 multi-function definition	0~40 【24】	Not modify in running
F0_13	LINE2 multi-function definition	0~40 【25】	
F0_14	LINE3 multi-function definition	0~40 【30】	
Definition of F0_12~F0_14:			
1 no definition		21 motor thermal protection	
2 no definition		22 fire action input	
3 medium speed down forced speed-changing switch		23 no definition	

4 medium speed up forced speed-changing switch	24 full load signal
5 no definition	25 overload signal
6 no definition	26 no definition
7 down limit	27 no definition
8 up limit	28 pre-opening feedback
9 emergency electric running	29 pre-opening adhesion
10 inspection signal	30 earthquake
11 inspection up button signal	31 no definition
12 inspection down button signal	32 no definition
13 up door area (rear door opening inspection)	33 open
14 down door area	34 close
15 no definition	35 UPS output signal inspection
16 no definition	36 dual brake travel detection
17 lock elevator signal	37 star-delta output detection
18 contact detection of the drive output contactor	38 no definition
19 contact detection of the brake contactor	39 no definition
20 brake travel switch detection	40 no definition

Function code	Instruction	Setting range 【default value】	Remarks
F0_15	MF output in the car	0~65535 【0】	Not modify in running
Unit: define RDC port of DC01, LED light corresponding to PAS Ten: define RDO port of DC01, LED light corresponding to DOD 0: closing/opening output light of rear door 1: opening delay light 2: mapping PLC Y5 of I/O board (following output and close of Y5) 3: mapping PLC Y6 of I/O board (following output and close of Y6) 4: low speed opening signal			



Function code	Instruction	Setting range 【default value】	Remarks
F0_16	Test mode	0~65535 【0】	Not modify in running
<p>0: no operation</p> <p>1: allow communication reset at drive fault</p> <p>8: close at fast arrival and shield calling (generally for debugging or test mode)</p> <p>16: Cancel double click number clearance</p> <p>64: Enable peristaltic UCM protection</p> <p>The parameter is multi-function selective. Several functions can be effective simultaneously by adding corresponding values. For example, when allowing communication reset at drive fault and close at fast arrival, set 1+8=9.</p>			

Function code	Instruction	Setting range 【default value】	Remarks
F0_17	Relative selection of CAN communication	0~65535 【0】	Not modify in running
<p>0: no operation</p> <p>1: open protocol</p> <p>2: OL voltage &gt;FL voltage&gt;LL voltage for weighing sensor of the car top board (also applicable to weighing sensor of the engine room)</p> <p>4: command number clearance after fast stop at door area, if not, deceleration point number clearance</p> <p>16: When the internal calling is open protocol, the external calling adopts internal protocol connected to the external calling line or open protocol connected to the internal calling line</p> <p>32: Communicating door operator</p> <p>The parameter is multi-function selective. Several functions can be effective simultaneously by adding corresponding values. For example, when clearing number at internal command of fast stop in door area under open protocol, set 1+4=5.</p>			

	<ul style="list-style-type: none"> <li>◆ When configuring calling board of the company, do not set to open protocol.</li> <li>◆ After changing into open protocol, power on the car control board or car</li> </ul>
---	---

	<p>board after adjustment. The MF output in the car and car weighing compensation are cancelled.</p> <p>◆ The parameter will not involve in default value reset.</p>
--	--

Function code	Instruction	Setting range 【default value】	Remarks
F0_18	Relative selection of elevator running	0~65535 【0】	Not modify in running
<p>0: no operation                      1: calling below 32 floor connected to inside line                      2: parallel calling scan in cycle                      4: speed involved in parallel control calculation                      8: communication IC card enabling                      16: no number clearance of internal calling remote reverse enabling                      32: home floor opening standby enabling                      64: during home floor opening standby, energy saving enabling (door beam will automatically cancel energy saving in the state.)</p> <p>The parameter is multi-function selective. Several functions can be effective simultaneously by adding corresponding values. For example, when enabling communication IC card, keeping home floor opening and energy saving are necessary, set 8+32+64=104.</p>			

Function code	Instruction	Setting range 【default value】	Remarks
F0_19	1387 encoder C/D sampling	0~65535 【0】	Not modify in running
<p>When the synchronous master lacks comfortability or the running current is high, and autotuning angle is unstable, redo autotuning after modifying P3.06~P3.08 as follows: to guarantee validity of sampling values, the motor runs at slow speed and rotates one cycle.</p> <p>0: current sampling value                      1: The Max. value in the latest running                      2: The Min. value in the latest running                      4: The average value in the latest running</p>			

Function code	Instruction	Setting range 【default value】	Remarks
F0_20	Filter coefficient of stop curve	0~65535 【0】	Not modify in running
0: disable Valid range 1~255 (generally unnecessary to set the value, modifiable when the elevator shakes after stopping in door area)			

Function code	Instruction	Setting range 【default value】	Remarks
F0_21	Peristaltic landing distance	0~65535 【0】	Not modify in running
0: disable Valid range 10~200mm (modifiable when the asynchronous motor drives by pulley or long floor rope slides)			

Function code	Instruction	Setting range 【default value】	Remarks
F0_22	UPS application	0~65535 【0】	Not modify in running
0: 220V power supply (The switching of drive power supply is controlled by Y6. Set KPWR input to normally closed logic. Detect UPS output feedback and bus voltage. After leveling open delay, disconnect Y6.) 1: 380V power supply (The switching of drive power supply is controlled by UPS itself. UPS bus voltage detection is unnecessary. After leveling open delay, output Y6, KPWR input optional.)			

	<ul style="list-style-type: none"> <li>◆ When using pre-opening or peristaltic landing, Y6 is forced as pre-opening request prior to output in UPS mode. In the case, select the 2<sup>nd</sup> UPS application, that is, the switching of power supply of the integrated machine is controlled by UPS itself or peripheral lines. If necessary, the peripheral lines control the disconnection of power supply after UPS returns to leveling.</li> </ul>
---	---

Function code	Instruction	Setting range 【default value】	Remarks
F0_23	MF definition of DS	0~65535 【0】	Not modify in running
0: original definition 1: opening keeping delay button 2: front/rear door selection 3: car firefighter input			

Function code	Instruction	Setting range 【default value】	Remarks
F0_24	Dual door area selection	0~65535 【0】	Not modify in running
1: Enable dual door area 2: Dual door area replaces slow limit switch 4: Return to leveling and correct pulses in the state of dual door area			

Function code	Instruction	Setting range 【default value】	Remarks
F0_26	Start time 1 of time sharing service	0~2359 【0】	Not modify in running
F0_27	Stop time 1 of time sharing service	0~2359 【0】	
F0_28	Time 1 of time sharing service Stop at 1~16 floors	0~65535 【0】	
F0_29	Time 1 of time sharing service Stop at 17~32 floors	0~65535 【0】	
F0_30	Time 1 of time sharing service Stop at 33~48 floors	0~65535 【0】	
F0_31	Time 1 of time sharing service Stop at 49~64 floors	0~65535 【0】	
F0_32	Start time 2 of time sharing service	0~2359 【0】	Not modify in running

F0_33	Stop time 2 of time sharing service	0~2359 【0】	Not modify in running
F0_34	Time 2 of time sharing service Stop at 1~16 floors	0~65535 【0】	
F0_35	Time 2 of time sharing service Stop at 17~32 floors	0~65535 【0】	
F0_36	Time 2 of time sharing service Stop at 33~48 floors	0~65535 【0】	
F0_37	Time 2 of time sharing service Stop at 49~64 floors	0~65535 【0】	
F0_38	Start time 3 of time sharing service	0~2359 【0】	
F0_39	Stop time 3 of time sharing service	0~2359 【0】	
F0_40	Time 3 of time sharing service Stop at 1~16 floors	0~65535 【0】	
F0_41	Time 3 of time sharing service Stop at 17~32 floors	0~65535 【0】	
F0_42	Time 3 of time sharing service Stop at 33~48 floors	0~65535 【0】	
F0_43	Time 3 of time sharing service Stop at 49~64 floors	0~65535 【0】	
<p>The parameters are 24-hour time system. If the start time and stop time are different, that is, enable time sharing service functions. According to system clock, the elevator will only stop at the set floors within the corresponding time.</p>			

Function code	Instruction	Setting range 【default value】	Remarks
F0_57	Front door 1~16 IC open floor	0~65535 【0】	Not modify in running
F0_58	Front door 17~32 IC open floor	0~65535 【0】	
F0_59	Front door 33~48 IC open floor	0~65535 【0】	
F0_60	Front door 49~64 IC open floor	0~65535 【0】	

After enabling the communication IC card (in F0\_18, bit3=1), open up 1~64 floor of front door by F0\_57~F0\_60. The set floor will record internal command without using IC card.  
 For example, in a shopping mall, parking is under the 1st floor, home landing on the 1st floor, stores on 2~5 floors, restaurants on the 12th floor, and other floors are private. The intelligent control solution by using communication IC card is as follows:  
 When F0\_18=8, the communication IC card is enabled. The home landing is fixed open floor in no need of setting; set F0\_57 to 1+4+8+16+32+4096=4157 to open up floors of the underground parking, stores and restaurants.

【F0_57 front door 1-8 floor】	Valid IC	Set value	【F0_57 front door 9-16 floor】	Valid IC	Set value
1 floor	0	1	9 floor	0	256
2 floor	0	2	10 floor	0	512
3 floor	0	4	11 floor	0	1024
4 floor	0	8	12 floor	0	2048
5 floor	0	16	13 floor	0	4096
6 floor	0	32	14 floor	0	8192
7 floor	0	64	15 floor	0	16384
8 floor	0	128	16 floor	0	32768

Function code	Instruction	Setting range 【default value】	Remarks
F0_61	Rear door 1~16 IC open floor	0~65535 【0】	Not modify in running
F0_62	Rear door 17~32 IC open floor	0~65535 【0】	
F0_63	Rear door 33~48 IC open floor	0~65535 【0】	
F0_64	Rear door 49~64 IC open floor	0~65535 【0】	

After enabling the communication IC card (in F0\_18, bit3=1), open up 1~64 floor of rear door by F0\_61~F0\_64. The set floor will record internal command without using IC card. 1 indicates open up and 0 indicates IC card is valid. The setting is the same as above setting of front door floors.

Function code	Instruction	Setting range 【default value】	Remarks
F0_70	Y5 relay output definition	0~65535 【0】	Not modify in running
F0_71	Y6 relay output definition	0~65535 【0】	



0 original definition of front/rear door output	11 low speed signal
1 output contactor control 1	12 UPS control
2 star-delta output	13 elevator lock return
3 brake contactor control 1	14 energy-saving output
4 brake contactor control 2	15 forced closing output
5 fire return	16 elevator up signal
6 front door opening output	17 important fault signal
7 front door closing output	18 reserved
8 rear door opening output	19 reserved
9 rear door closing output	20 reserved
10 pre-opening output	21~99 no definition

 <b>Caution</b>	◆ When using pre-opening or peristaltic landing, Y5 is forced as low speed signal and Y6 is forced as pre-opening request.
--	--

Function code	Instruction	Setting range 【default value】	Remarks
F0_75	Analog LL set voltage	0~65535 【0】	Not modify in running
F0_76	Analog FL set voltage	0~65535 【0】	
F0_77	Analog OL set voltage	0~65535 【0】	

After setting P4.23 to non-zero, F0\_75, F0\_76 and F0\_77, obtain the load state by setting voltage without need of load autotuning.



**6.5.19 Parameters setting--calling signal**

<p><b>【 main menu 】</b></p> <p>A system control</p> <p>B fault record</p> <p>C language selection</p> <p><b>D parameters setting inquiry</b></p> <p>E password setting</p> <p>F system autotuning</p> <p>G data management</p> <p>H system information</p>		<p><b>【 parameters setting inquiry 】</b></p> <p>P0 master drive control</p> <p>P1 speed and deceleration distance</p> <p>P2 motor parameters</p> <p>P3 encoder parameters</p> <p>P4 running comfortability</p> <p>P5 elevator protection parameters</p> <p>P6 communication setting</p> <p>P7 drive information</p> <p>PE factory only</p>		<p><b>【 U0 calling signal 】</b></p> <p><b>Random calling enabling</b></p>
--	--	--	--	---

	A1 floor setting A2 floor displaying H0 logic of the IO control board H1 logic of the car control board H2 front door stopping floor H3 rear door stopping floor H4 front/ rear door stopping floor L0 parallel and group control setting T0 time setting F0 function setting <b>U0 calling signal</b> U1 system monitoring U2 hoistway information	
--	---	--

10 times of the set value of U0\_00 for random calling enabling is the random running time. It will be cleared after powering off.

### 6.5.20 Parameters setting---system monitoring

<b>【main menu】</b> A system control B fault record C language selection <b>D parameters setting inquiry</b> E password setting F system autotuning G data management H system information		<b>【parameters setting inquiry】</b> P0 master drive control P1 speed and deceleration distance P2 motor parameters P3 encoder parameters P4 running comfortability P5 elevator protection parameters P6 communication setting		<b>【U1 system monitoring】</b> <b>Running time low bit</b> Running time high bit Total running time low bit Total running time high bit Current reference speed of the elevator Reference frequency monitoring Magnetic pole position angle Static autotuning detection current
---	---	--	---	--



P7 drive information  
 PE factory only  
 A1 floor setting  
 A2 floor displaying  
 H0 logic of the IO control board  
 H1 logic of the car control board  
 H2 front door stopping floor  
 H3 rear door stopping floor  
 H4 front/ rear door stopping floor  
 L0 parallel and group control setting  
 T0 time setting  
 F0 function setting  
 U0 calling signal  
**U1 system monitoring**  
 U2 hoistway information

C-phase sampling  
 D-phase sampling  
 Current height of the elevator  
 Current floor of the elevator  
 Leveling distance  
 Input terminal state 1-16  
 Input terminal state 17-32  
 Extension input terminal state  
 High voltage input state  
 Input terminal state of the main board in car  
 Output terminal state  
 Current feedback speed of the elevator  
 Running state of the elevator  
 Output current  
 Output voltage  
 Output frequency  
 Output rotating speed  
 Output power  
 Bus voltage  
 Torque command  
 Torque compensation  
 Current load  
 Calculated deceleration distance  
 Calculated stopping distance  
 Analog input voltage  
 Extension output terminal state  
 Output state of the main board in car

### 6.5.21 Parameters setting--hoistway information

The parameters are used to check the floor height and installation distance of the deceleration switch after the elevator autotuning.

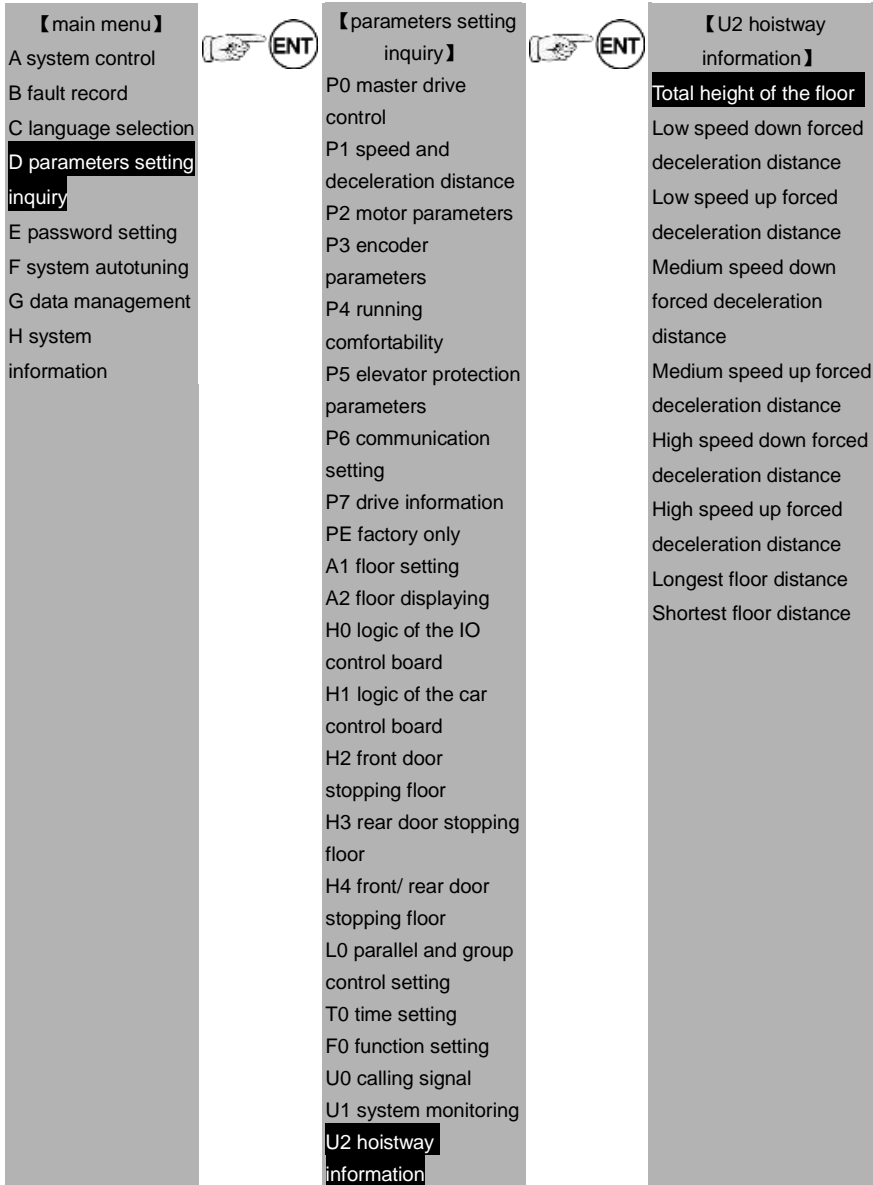

## 6.6 Password setting

<p><b>【main menu】</b></p> <p>A system control</p> <p>B fault record</p> <p>C language selection</p> <p>D parameters setting inquiry</p> <p><b>E password setting</b></p> <p>F system autotuning</p> <p>G data management</p> <p>H system information</p>		<p><b>【password setting】</b></p> <p>(1) monitoring password</p> <p>(2) debugging password</p> <p>(3) factory password</p>
--	---	---

## 6.7 System autotuning

<p><b>【main menu】</b></p> <p>A system control</p> <p>B fault record</p> <p>C language selection</p> <p>D parameters setting inquiry</p> <p>E password setting</p> <p><b>F system autotuning</b></p> <p>G data management</p> <p>H system information</p>		<p><b>【system autotuning】</b></p> <p>[1] hoistway information autotuning</p> <p>[2] motor rotating autotuning</p> <p>[3] motor static autotuning</p> <p>[4] LL weighing autotuning</p> <p>[5] FL weighing autotuning</p> <p>[6] OL weighing autotuning</p>
--	---	--

## 6.8 Data management

<p><b>【main menu】</b></p> <p>A system control</p> <p>B fault record</p> <p>C language selection</p> <p>D parameters setting inquiry</p> <p>E password setting</p> <p>F system autotuning</p>		<p><b>【data management】</b></p> <p>[1] data saving of the controller</p> <p>[2] restore to the factory value</p> <p>[3] fault history clearance</p> <p>[4] data of the controller</p>
--	---	---

G data management

H system information

to PAD

[5] PAD data to the controller

- [1] Data saving of the controller: save the data before powering off after changing, if not, invalid.
- [2] Restore to the factory value: restore the parameters of the controller to the factory setting.
- [3] Fault history clearance: clear the fault history.
- [4] Save the data of the controller to PAD.
- [5] Download PAD data to the controller and save the data before powering off.

### 6.9 System information

【main menu】

- A system control
- B fault record
- C language selection
- D parameters setting inquiry
- E password setting
- F system autotuning
- G data management
- H system information



【system information】

Software version of the main control: 1.00  
 Software version of the car: 2.10  
 Software version of the group control: 0.00  
 DSP software version: 1.01  
 FPGA software version: 1.04  
 PAD software version: 1.19  
 Rated power: 011.0kW  
 Running time: 88H  
 2014/08/15 17:28 Fri

The rated power is that of the integrated machine and the running time is the accumulative running time of the elevator.

## Chapter 7 Running at slow speed

### 7.1 Inspection before power on

#### 7.1.1 Machinery assembly, inspection and confirmation

- Bracket, rail, traction machine, car, rope, control cabinet and governor are installed according to the standards.
- Confirm all the assembly of the safety circuit, such as four emergency stop buttons of engine room/car/car top/pit, phase sequence, governor switch, up/down limit switch, hydraulic buffer switch, rope broken switch, safety plier switch and safety window switch, are well installed and in the normal working state.
- Check the installation of all hall and car doors to ensure valid action and normal working state.
- Remove all scaffolds and other obstacles in the hoistway.

#### 7.1.2 Electrical assembly, inspection and confirmation

1. Check the connection of:
  - (1) Three-phase wires between the power supply cabinet and the control cabinet
  - (2) The connection between the braking coil of the master and the control cabinet.
  - (3) The connection between U1, V1 and W1 of the control cabinet and the three-phase wires of the master motor.
  - (4) The connection between the master encoder and the control cabinet.
  - (5) The safety circuit
  - (6) The door lock circuit
  - (7) The car top connection
  - (8) Logic of the inspection circuit
  - (9) Power supply and signal connection of the door operator
  - (10) CAN communication circuit connection of the car
  - (11) RS-485 communication circuit connection of the hoistway
2. Connect the communication cables of the hoistway and car to the control cabinet
  - (1) Confirm the connection of the terminal resistor on the DC-03F board in the car
  - (2) Ensure the connection of the terminal resistor on the DC-03F board in the bottom hoistway module
  - (3) Connect the hoistway communication module, the resistance is about 60Ω.
  - (4) Connect the car communication module, the resistance is about 60Ω.
3. Check the resistance of three phase of the motor

#### 4. Check the grounding

(1) In the following inspection, the resistor between the measuring terminal/parts and PE closes to infinity.

- A. Between R, S, T and PE
- B. Between the braking coil and PE
- C. Between safety circuit and PE
- D. Between door lock circuit and PE
- E. Between the control power supply and PE
- F. Between the communication circuit and PE
- G. Between motor U, V, W and PE
- H. Between the rotating circuit of the encoder and PE
- I. Between the unit signal terminal of the machine and the power terminal and PE
- J. Between the terminal in the inspection circuit and PE

In above inspection, if the resistor is a little small, please check immediately and find the solution.

(2) In the following inspection, the resistor between the measuring terminal/parts and PE closes to infinitesimal ( $0\sim 3\Omega$ ):

- A. Between mains power supply and PE
- B. Between the motor contact and PE
- C. Between the shield cable of the rotating encoder and PE
- D. Between the external metal host of the rotating encoder and PE
- E. Between the contact of the machine and PE
- F. Between the power contact and PE
- G. Between the brake contact and PE
- H. Between the control cabinet and door and PE
- I. Between the coil end and PE
- J. Between the governor and PE
- K. Between the car and PE
- L. Between the electrical door lock and PE
- M. Between the connector of the safety switch and PE



- ◆ Ensure the connection of the grounding wires in the power supply meets the national standards before debugging.

#### 7.1.3 Inspection of the encoder assembly

(1) Ensure the fixing of the encoder is tightened enough and the coupling between the encoder shaft and the outrigger shaft of the master.

- (2) The connection of the encoder is brought into the control cabinet.
- (3) If the connection cable is not long enough, it is necessary to lengthen the cables and the cables should be shield cables. It is recommended to weld the connection wires and the wire should be isolated from each other with the metal shield.
- (4) Connect according to the color of the connection diagram and the encoder.
- (5) The shield cables are connected to the grounding terminal in the control cabinet.
- (6) The cable of the encoder should be arranged in the metal hose to the control cabinet. The ends should be connected with proper techniques and the end of the metal hose in the control cabinet should be grounded.

If the shield cable of the encoder is grounded , then it can not be connected, but ensure the cable is not connected with any electrical terminal or grounding chassis.

## 7.2 Inspection after power on

1. Following steps is needed after the first inspection:

- (1) Ensure all the switches and fuses are off
- (2) Ensure the inspection/normal switch is in the right position, the emergence-stop switch is off.
- (3) Ensure the inspection switch on and in the car is in the right position.
- (4) Ensure there is nobody in the hoistway, car, on the top of the car and at the bottom of the hoistway and the elevator can run safely.
- (5) Ensure the working outside the hoistway does not affect the running of the elevator.

2. Check the site bus voltage, the 3-phase voltage is  $380\pm 7\%$ VAC and the phase bias is no more than 15VAC. The single voltage between each phase and the N wire is  $220\pm 7\%$ VAC. If N line and PE is connected, then the voltage between N-PE is no more than 30VAC.

3. Ensure the wire specification and the total switching capacity should reach the total requirements of the diagram.

4. Power on debugging if all inspections are correct.

5. Inspection after power on:

- (1) Switch on the main power switch and check the phase sequence relay, if the green light is on, the phase is normal, otherwise, switch off the power and exchange any two-phase lines.
- (2) Check the fault immediately if fault occurs.

A. Check the voltage between 24V+ and 24V- is  $24.3V\pm 0.3V$ .

B. Check the relay in the control cabinet

Relay name	Close/release
Phase sequence relay	Action



(3) Input the password on the manual controller and enter into the parameters menu. After



checking the parameters, set according to the actual debugging.

### 7.3 Static self-tuning of the synchronous motor

	<p>◆ Autotuning is needed before the first slow running of synchronous master, otherwise damage to the machine and motor and physical injury or death may occur.</p>
---	--

The synchronous motor must conduct self-tuning before running; otherwise, damage to the machine and motor may occur because of incorrect parameters.

<div style="background-color: #cccccc; padding: 5px;"> <p style="text-align: center; margin: 0;"><b>【main menu】</b></p> <p>A system control</p> <p>B fault record</p> <p>C language selection</p> <p style="background-color: black; color: white; padding: 2px;">D parameters setting inquiry</p> <p>E password setting</p> <p>F system autotuning</p> <p>G data management</p> <p>H system information</p> </div>		<div style="background-color: #cccccc; padding: 5px;"> <p style="text-align: center; margin: 0;"><b>【parameters setting inquiry】</b></p> <p>P0 master drive control</p> <p>P1 speed and deceleration distance</p> <p style="background-color: black; color: white; padding: 2px;">P2 motor parameters</p> <p>P3 encoder parameters</p> <p>P4 running comfortability</p> <p>P5 elevator protection parameters</p> <p>P6 communication setting</p> <p>P7 drive information</p> <p>PE factory only</p> </div>		<div style="background-color: #cccccc; padding: 5px;"> <p style="text-align: center; margin: 0;"><b>【P2 motor parameters】</b></p> <p style="background-color: black; color: white; padding: 2px;">00 motor type selection</p> <p>01 rated power of the motor</p> <p>2 rated frequency of the motor</p> <p>03 rated speed of the motor</p> <p>04 rated voltage of the motor</p> <p>5 rated current of the motor</p> <p>06 stator resistor of the motor</p> <p>07 rotor resistor of the motor</p> <p>08 Motor stator and rotor inductance</p> <p>09 Motor stator and rotor mutual inductance</p> <p>10 Motor non-load current</p> </div>
---	---	--	---	--

<div style="background-color: #cccccc; padding: 5px;"> <p style="text-align: center; margin: 0;"><b>【main menu】</b></p> <p>A system control</p> <p>B fault record</p> </div>		<div style="background-color: #cccccc; padding: 5px;"> <p style="text-align: center; margin: 0;"><b>【parameters setting inquiry】</b></p> <p>P0 master drive</p> </div>		<div style="background-color: #cccccc; padding: 5px;"> <p style="text-align: center; margin: 0;"><b>【P3 encoder parameters】</b></p> <p style="background-color: black; color: white; padding: 2px;">00 encoder type selection</p> <p>01 resolution of the</p> </div>
--	---	--	---	--



C language selection	control	encoder
<b>D parameters setting inquiry</b>	P1 speed and deceleration distance	02 encoder direction
E password setting	P2 motor parameters	03 low-speed encoder disconnection detection time
F system autotuning	<b>P3 encoder parameters</b>	04 high-speed encoder disconnection detection time
G data management	P4 running comfortability	05 reverse detection time of the encoder
H system information	P5 elevator protection parameters	06 amplitude gain pole position
	P6 communication setting	07 C-phase magnetic pole bias
	P7 drive information	08 D-phase magnetic pole bias
	PE factory only	09 original position of the magnetic pole
		10 static identification current
		11 pulse counting direction

Function code	Name	Instruction
P0_00	Speed control mode	0-2 【1】
P2_00	Motor type	0: AM 1: SM
P2_01	Rated power of the motor	Depend on the name plate
P2_02	Rated frequency of the motor	Depend on the name plate
P2_03	Rated speed of the motor	Depend on the name plate
P2_04	Rated voltage of the motor	Depend on the name plate
P2_05	Rated current of the	Depend on the name plate

Function code	Name	Instruction
	motor	
P3_00	Encoder type	0: Incremental encoder (AM) 1: SIN/COS encoder (synchronous 1387) 2: UVW encoder (synchronous 8192) 3: Endat encoder (synchronous 1313)
P3_01	Resolution of the encoder	1~10000
P3_06	Magnetic pole position amplitude gain	0.50~1.50 (normal 0.98~1.02)
P3_07	C-phase magnetic pole bias	0000~9999 (normal 390~400)
P3_08	D-phase magnetic pole bias	0000~9999 (normal 390~400)
P3_10	Static identification current	0~150% (depend on the master, generally 40~60)

Enter into the system autotuning menu to select the motor static autotuning.

<p><b>【main menu】</b></p> <p>A system control</p> <p>B fault record</p> <p>C language selection</p> <p>D parameters setting inquiry</p> <p>E password setting</p> <p><b>F system autotuning</b></p> <p>G data management</p> <p>H system information</p>		<p><b>【system autotuning】</b></p> <p>[1] hoistway information autotuning</p> <p>[2] motor rotating autotuning</p> <p>[3] motor static autotuning</p> <p>[4] LL weighing autotuning</p> <p>[5] FL weighing autotuning</p> <p>[6] OL weighing autotuning</p>
--	---	--

Steps of static autotuning	<ol style="list-style-type: none"> <li>1. Check the connection of master UVW, grounding wires, brake and encoder.</li> <li>2. Connect the safety and door lock circuit and check the parameters setting of master and encoder in the inspection state.</li> </ol>
----------------------------	---

	<p>3. Enter into the static identification current menu, set P3_10 and enter into the main menu-F system autotuning-[3] motor static autotuning. Then the operational interface of the manual controller will display “please confirm the inspection state?”. If select [YES], then the interface will display “please confirm the autotuning?”. If confirmed, master autotuning will begin.</p> <p>4. Reconfirm the brake is in the closing state, if select [YES], press the inspection up button, and then the running contactor will close automatically to begin the autotuning and the controller will display the motor is autotuning. After about 0.5s, the motor will squeak to end the autotuning and the running contactor releases automatically.</p> <p>5. If the master autotuning succeeds, the manual controller will display “autotuning succeed”. Press ESC to retreat the interface, and then enter main menu-G data management-[1]data saving interface of controller to save the data. If the manual controller display “autotuning failed”, find the fault reason.</p>
<p>Precautions in autotuning</p>	<p>1. In the master autotuning, if any abnormality occurs, press the emergency-stop button or switch off the power supply to stop autotuning.</p> <p>2. If the autotuning is failed, first confirm the brake is closed or not, and the connection of the encoder and the static identification current P3_10.</p> <p>3. Check the detection current of static autotuning U1_07 is in 80~120%; otherwise, static autotuning will repeat after changing the static identification current P3_10.</p> <p>4. In the autotuning, the direction of the encoder is not detected. Repeat the autotuning twice and record the value of P3_09. If the three results are the same, the setting of P3_02 is correct, otherwise change the setting of P3_02 and reautotune.</p> <p>5. Judge the direction of the elevator before the first trial running to avoid collision limit. If the inspection running direction is different from the actual direction, change the value of P0_08.</p> <p>6. Try to inspect the up/down running elevator when entering into the drive monitoring interface. If the feedback current is in normal state, the motor autotuning is finished. Otherwise please check the parameters setting in P0, P2 and P3 group and the autotuning steps.</p>

Enter into static autotuning:

**【motor static autotuning】**  
Whether in the inspection state?

[Y] [N]

Select [Yes] and enter:

**【 motor static autotuning 】**  
 Whether begin the motor autotuning?  
 [Y] [N]

Select [Yes] and enter, and press the up inspection button:

**【 motor static autotuning 】**  
 Motor autotuning...

If succeeded, then

**【 motor static autotuning 】**  
 Autotuning succeeded

If failed, then

**【 motor static autotuning 】**  
 Autotuning failed

	<ul style="list-style-type: none"> <li>◆ Save the parameters after autotuning.</li> <li>◆ The static autotuning of asynchronous motor is the same as above. After finishing autotuning, update P2_06~P2_10.</li> <li>◆ To ensure the accuracy, there will be about 4 minutes for the static autotuning of asynchronous motor and discontinuous electromagnetic acoustic. After the end of autotuning, the operator will prompt autotuning succeeded or failed.</li> </ul>
---	---

### 7.4 Rotating autotuning of the motor

Ensure the wire rope on the motor is removed before the rotating autotuning and the input parameters are correct.

Function code	Name	Instruction
P0_00	Speed control mode	0-2 <b>【 1 】</b>
P2_00	Motor type	0: AM 1: SM
P2_01	Rated power of the motor	Depend on the name plate
P2_02	Rated frequency of the motor	Depend on the name plate
P2_03	Rated speed of the motor	Depend on the name plate
P2_04	Rated voltage of the motor	Depend on the name plate

Function code	Name	Instruction
P2_05	Rated current of the motor	Depend on the name plate
P3_00	Encoder type	0: Incremental encoder (AM) 1: SIN/COS encoder (synchronous 1387) 2: UVW encoder (synchronous 8192) 3: Endat encoder (synchronous 1313)
P3_01	Resolution of the encoder	1~10000

Enter into the main menu-F system autotuning to select motor rotating autotuning.

<p><b>【main menu】</b></p> <p>A system control</p> <p>B fault record</p> <p>C language selection</p> <p>D parameters setting inquiry</p> <p>E password setting</p> <p><b>F system autotuning</b></p> <p>G data management</p> <p>H system information</p>		<p><b>【system autotuning】</b></p> <p>1) hoistway information autotuning</p> <p>[2] motor rotating autotuning</p> <p>[3] motor static autotuning</p> <p>[4] LL weighing autotuning</p> <p>[5] FL weighing autotuning</p> <p>[6] OL weighing autotuning</p>
--	---	---

<p>Steps of rotating autotuning</p>	<ol style="list-style-type: none"> <li>1. Check the connection of master UVW, grounding wires, brake and encoder.</li> <li>2. Ensure the wire rope on the motor is removed before the rotating autotuning and no damage may occur during rotating.</li> <li>3. Connect the safety and door lock circuit and check the parameters setting of master and encoder in the inspection state.</li> <li>4. Enter into the main menu-F system autotuning-[2] motor rotating autotuning. Then the operational interface of the manual controller will display “please confirm the inspection state?”. If select [YES], then the interface will display “please confirm the autotuning?”. If confirmed, master autotuning will begin.</li> <li>5. The brake contactor is in the closing state when selecting [YES]. Press the inspection up button, and then the running contactor will close automatically to begin the autotuning and the controller will display the motor is autotuning. After</li> </ol>
-------------------------------------	---

	<p>about 30s, the motor will finish autotuning and the running contactor releases automatically.</p> <p>6. If the master autotuning succeeds, the manual controller will display "autotuning succeeded". Press ESC to retreat the interface, and then enter main menu-G data management-[1]data saving interface of controller to save the data. If the manual controller display "autotuning failed", find the fault reason.</p>
Precautions in autotuning	<ol style="list-style-type: none"> <li>1. In the master autotuning, if any abnormality occurs, release inspection up button immediately, then press the emergency-stop button or switch off the power supply to stop autotuning.</li> <li>2. If the autotuning is failed, first confirm the brake is closed or not.</li> <li>3. If the master vibrates during autotuning, enter into parameters of P4 group to reduce speed loop and current loop.</li> <li>4. If the master rotates abnormally and alarms encoder disconnection, repeat autotuning after modifying encoder direction P3_02.</li> <li>5. Record and compare the value of P3_09 three times. If the deviation is small and the running current at non-load is normal, the autotuning is successful; otherwise, check the setting of P0, P2 and P3 is consistent with parameters of the name plate and encoder and the autotuning steps.</li> <li>6. Judge the direction of the elevator before the first trial running to avoid collision limit. If the inspection running direction is different from the actual direction, change the value of P0_08.</li> </ol>

Enter into the autotuning:

**【 motor rotating autotuning 】**  
Whether in the inspection state?  
[Y]            [N]

Select [Yes] and enter:

**【 motor rotating autotuning 】**  
Whether begin the motor autotuning?  
[Y]            [N]

Select [Yes] and enter, and press the up inspection button:

**【 motor rotating autotuning 】**  
Motor autotuning...

If succeeded, then

**【 motor rotating autotuning 】**  
Autotuning succeeded

If failed, then

**【motor rotating autotuning】**  
Autotuning failed

	<ul style="list-style-type: none"> <li>◆ Save the parameters after autotuning.</li> <li>◆ The autotuning of asynchronous motor is the same as above. After finishing autotuning, update P2_06~P2_10.</li> </ul>
---	---

## 7.5 Inspection running

1. Switch on the general power and reset the emergency-stop switch of the control cabinet.
2. Smooth safety circuit: normal phase sequence, emergency-stop button of the control cabinet reset.
3. Smooth door lock circuit: serial circuit of the car and hall
4. Smooth up and down limit circuit
5. The up/down forced deceleration circuit need to keep smooth, otherwise the actual running speed is the leveling speed when slow running.
6. Good connection of the inspection circuit
7. Press the UP/DOWN button to run UP/DOWN at slow speed in inspection:
  - (1) The manual controller can display the current running speed or frequency when the elevator is running.
  - (2) Check the receiving and output state in the manual controller.
  - (3) Enter into the parameters setting-drive control of the master-running direction selection to change the running direction if the running direction of the elevator is different from the direction of the button.
  - (4) Check the displayed speed in the manual controller. The up running is the positive value and the down running is the negative value. If abnormal, enter into the parameters setting-encoder parameters-pulse counting direction to the change the value.
  - (5) Check if the displayed speed in the manual controller corresponds to the set speed. If the fluctuation is large, check the grounding of the encoder and the motor.
  - (6) When the elevator slides at starting, enlarge speed loop gain P4\_00 properly. The synchronous motor needs to check whether P4\_14 is set to 1 and enlarge P4\_17 properly.
  - (7) When sliding at stop, extend inspection stop delay T0\_08.
8. Carry out the rest connection if the slow running of the engine room is normal.

## Chapter 8 Debugging at fast speed

### 8.1 Inspection and confirmation of the electrical assembly

1. The connections of the engine room and beam are correct.
2. The connection and installation size of the leveling switch on the car top are correct.
3. All safety switches in the hoistway can act validly.
4. The installation position of the up/down limit switches in the hoistway is correct and the switches can act validly.
5. The installation position of the up/down limit switches is correct and the switches can act validly.
6. The installation position of the up/down forced deceleration switches are correct and the switches can act validly.

**Terminal deceleration switch:** if the speed of the elevator is less than 1.75m/s, install SDS1 and SUS1; if the speed of the elevator is between 2.0~3.0m/s, install SDS2 and SUS2. For details, refer to 4.5.1 *Electrical installation of hoistway*.

7. The connection of the interphone is correct and can work normally.
8. The connection of the arrival gong is correct.
9. The connection of the calling communication board is reliable and correct.
10. Switch off the main power supply and check the communication wires.
  - (1) check whether the terminal resistor on DC-03F board in the car is short circuited.
  - (2) measure the module cable of the hoistway communication to keep about 60Ω.
  - (3) measure the module cable of the car communication to keep about 60Ω.
11. The connections of the car light and fan are correct.

### 8.2 Power on and check

1. Following steps need to be confirm and check after the action in section 1:
  - (1) Switch off the power supply.
  - (2) Ensure all switches are off.
  - (3) Ensure all inspection/automatic switches are in the inspection position and the emergency-stop switch is pressed.
  - (4) Ensure there is nobody in the hoistway and car and the elevator is in the safe condition.
  - (5) Ensure the running of the elevator is not affected by the outside.
2. Inspection and debugging of the door operator
  - (1) Switch on the power supply.
  - (2) Restore the emergency-stop switch of the control cabinet.
  - (3) Switch on the power supply of the door operator of the control cabinet and the



inspection/automatic switch in the inspection position.

(4) Ensure the voltage between the power terminal of the door operator is  $220V \pm 7\%VAC$ .

(5) Debug according to the instruction of the door operator.

(6) Check the opening and closing of the door operator.

A. Set the door in the automatic state and the door is closed.

B. Press the opening relay and the door opens.

C. Press the closing relay and the door closes.

D. When the door is open totally, press the UP/DOWN button, the door closes automatically.

(7) Check the door closed/open actions.

A. Stop the elevator in the leveling position and dial the inspection/automatic switch in the normal position and the door is closed.

B. Monitor the automatic state in the manual controller.

### 3. Inspection of the beam

Check and correct according to the installation of the beam. In the automatic mode, enter to monitor the input state:

(1) Switch off the power supply of the elevator and connect the car communication, and then switch on the power supply.

(2) Confirm the display screen of the car is correct and change with the displaying on the manual controller in the control cabinet.

(3) Short circuit the terminal resistor.

### 4. Connection inspection of the leveling sensor

(1) Connect the leveling sensor according to the diagram.

(2) Inspect the signal of the leveling sensor.

(3) Inspect the position of the limit switch.

A. The car runs up until to the up limit switch acts, then the sill of the car is above the sill of he hall about 50mm.

B. The car runs down until to the down limit switch acts, then the sill of the car is below the sill of he hall about 50mm.

C. Cross-circuit the up/down limit switch, and the car goes up/down until the safety switch acts, and then the sill of the car is above the sill of he hall about 250mm.

D. The car runs down until to the down limit safety switch acts, then the sill of the car is below the sill of he hall about 250mm.

E. After the adjustment, remove the cross-connection and restore the original connection.

### 5. Inspection and adjustment of the terminal forced deceleration switch

(1) Up terminal forced deceleration switch and down terminal forced deceleration switch

- (2) The elevator runs up to the up terminal forced deceleration switch acts, then the sill of the car is below the sill of the hall about X (refer to 4.5.2).
- (3) The elevator runs down to the down terminal forced deceleration switch acts, then the sill of the car is above the sill of the hall about X (refer to 4.5.2).
- (4) After the adjustment, restore the original connection.
- 6. Check the installation position and quantity of each leveling plate.

### 8.3 Parameter check

Check the controller parameters one by one according to the actual technical parameters. If there is non-stopping floor on site and the non-stopping floor has no magnet vane, please set the total floor as the actual stopping floor.

### 8.4 Autotuning of the hoistway position

- 1. Adjust the autotuning speed of the elevator (100mm/s by default, lower autotuning speed contributes to fast leveling accuracy) and the elevator is in the state of engine room inspection state.
- 2. Before autotuning, stop the elevator in the door area at the bottom floor. At the time, the single down terminal deceleration switch needs to act and confirm the corresponding signal on the main board.
- 3. Keep the safety circuit smooth.
- 4. Ensure the safety running of the elevator in the hoistway.
- 5. Begin the autotuning through the manual controller.
- (1) Enter into the system autotuning menu and select the hoistway autotuning.

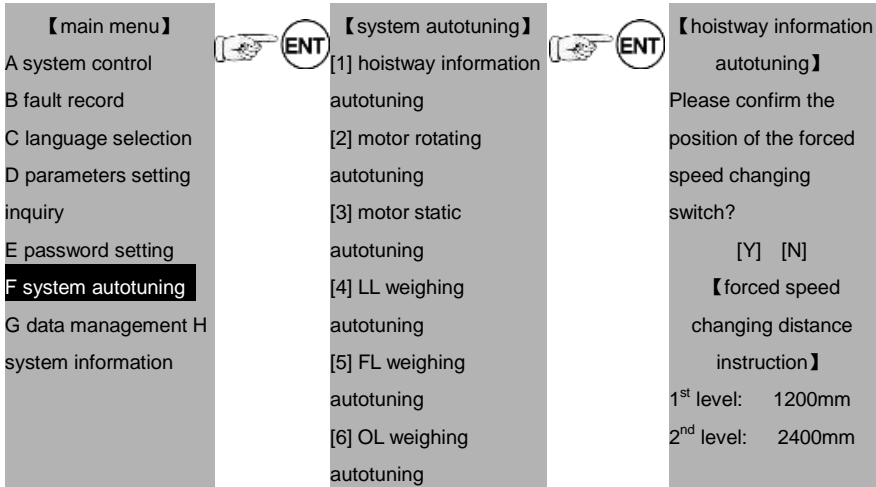

Select [Y] to enter

【hoistway information  
autotuning】  
Please ensure the  
inspection state?  
Please ensure whether  
it is in the inspection  
state?  
Whether the car is in  
the door area of  
ground floor?  
[Y] [N]

Select [Y] to enter

【hoistway information  
autotuning】  
Please ensure to begin  
the hoistway information  
autotuning?  
[Y] [N]

Select [Y] to enter

【hoistway information  
autotuning】  
hoistway information  
autotuning...  
Current floor: 1  
Car position: 0mm  
Elevator speed: 0mm/s

After confirmation, press the inspection up button until the elevator leaves the door area and release, and then the elevator will begin autotuning at the inspection speed and record the position of the leveling plate and the up/down terminal deceleration switches.

(2) The manual controller will display the relative information on floor and speed.

When the elevator runs to the top door area, the system will end the autotuning and the manual controller will display the following interface:

【hoistway information autotuning】  
Succeeded.

(3) Save the autotuning data and retreat the displaying of the manual controller to the state interface.

If failed, then

【hoistway information autotuning】  
Failed.



## 8.5 Autotuning of the hoistway position by the up/down button

The autotuning of the hoistway position operated by the up/down button on the panel:

1. Inspect running to the door area at the bottom
2. Press the up and down buttons simultaneously for about 5s until the LED displays 1
3. Press the up button and do not release it
4. Press inspection up button, then the LED displays the floor and the decimal point flickers
5. Release the up button on the panel and inspection up button after leaving the door area
6. When the elevator runs to the door area at the top: the LED will displays “OP” if autotuning succeeded and “Er” if autotuning failed.

	<ul style="list-style-type: none"> <li>◆ The high speed counting is in reverse direction. When the elevator goes up, the current height reduces. Please make adjustment according to the precautions of the master in autotuning;</li> <li>◆ The number of light panels in door area and the total floors have position deviation or different setting. Please check whether the signals from door area is consistent with the total floors;</li> <li>◆ Down low speed forced deceleration switch does not reset or is offline;</li> <li>◆ Up low speed forced deceleration switch adhesion or installed too high;</li> <li>◆ Due to each adjustment on the deceleration switch, redo the hoistway autotuning.</li> </ul>
---	---

### 8.6 Run at fast speed

	<ul style="list-style-type: none"> <li>◆ Avoid terminal landing running in first running at fast speed.</li> </ul>
	<ul style="list-style-type: none"> <li>◆ Ensure the protection switches in safety circuit are correct and reliable.</li> <li>◆ Ensure there is no short circuit of the car and hall lock and the locks can work normally.</li> <li>◆ Ensure the forced deceleration switches and limit switch at slow speed can work normally.</li> <li>◆ Ensure the hoistway autotuning are succeeded. And the logic setting of the main board and car main controller is correct.</li> <li>◆ The elevator runs at slow speed to the leveling of the terminal landing. Correct the floor displaying and inspect normally. The elevator will open and close the door automatically to ensure the outside/inside calling communication is normal.</li> </ul>

Run at fast speed in the engine room after the hoistway autotuning, and monitor the feedback speed on the manual controller.

1. Check nobody is in the car, car top or pit and the doors of the hall and car are closed. Ensure the safety circuit and door lock circuit are normal.
2. Slowly run the elevator in the engine room to the medium floor, then change into automatic state. If register single-deck command in the controller, the elevator will run at single-deck speed. Inspect feedback speed, leveling signal and tractor to check if working normally; if not, adjust relative parameters.
3. After proper single-deck running, register double-deck command and make the elevator run at double-deck speed to check whether in normal state.
4. After proper double-deck running, register multi-deck command to check whether in normal

state.

5. After proper multi-deck running, make the elevator run at multi-deck speed to the top and bottom to check whether in normal state.

6. After proper top/bottom running, check the up forced deceleration switch distance and down forced deceleration switch distance meet the requirements, and no top-hitting or bottom-clashing; otherwise, adjust the distance.



**Caution**

- ◆ Redo the hoistway autotuning after adjusting the up/down forced deceleration switch.

## 8.7 S Curve adjustment

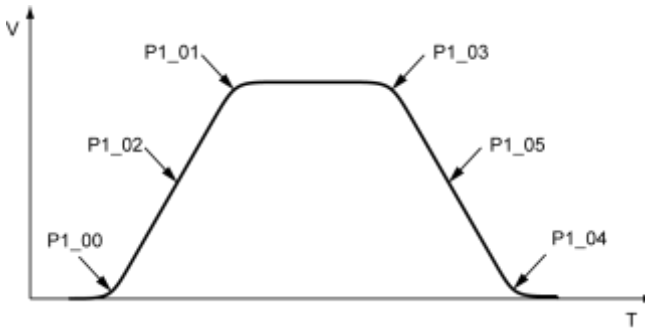

Figure 8-1 S curve adjustment

## 8.8 Leveling adjustment

1. The leveling plate are plugged in the photoelectric switch or magnetic switch for about 2/3 and check the depth of each plate are the same and as vertical as possible.
2. Keep the center of the plate and sensor is in one line when installation.
3. Record the distance between the car sill and hall sill when the elevator goes up/down to a floor.
4. Leveling adjustment: If the leveling overshoots at fast stop (stop running after reaching the leveling line), enlarge the running distance of the elevator on the basis of original leveling precision; if the leveling lacks (stop running before reaching the leveling line), reduce the running distance of the elevator on the basis of original leveling precision.
5. Interference and bad quantity of the rotating encoder may affect the leveling precision.

Ensure the connection of the encoder is shield cable, and the shield layer needs to be grounded at the end of the control cabinet. The connection of the encoder and the power cables can not route in one trough.



**Caution**

- ◆ Redo the hoistway autotuning after adjusting the leveling switch, magnet vane or forced deceleration switch.

## 8.9 Comfortability

### 8.9.1 Vector control of the sequence in fast-running

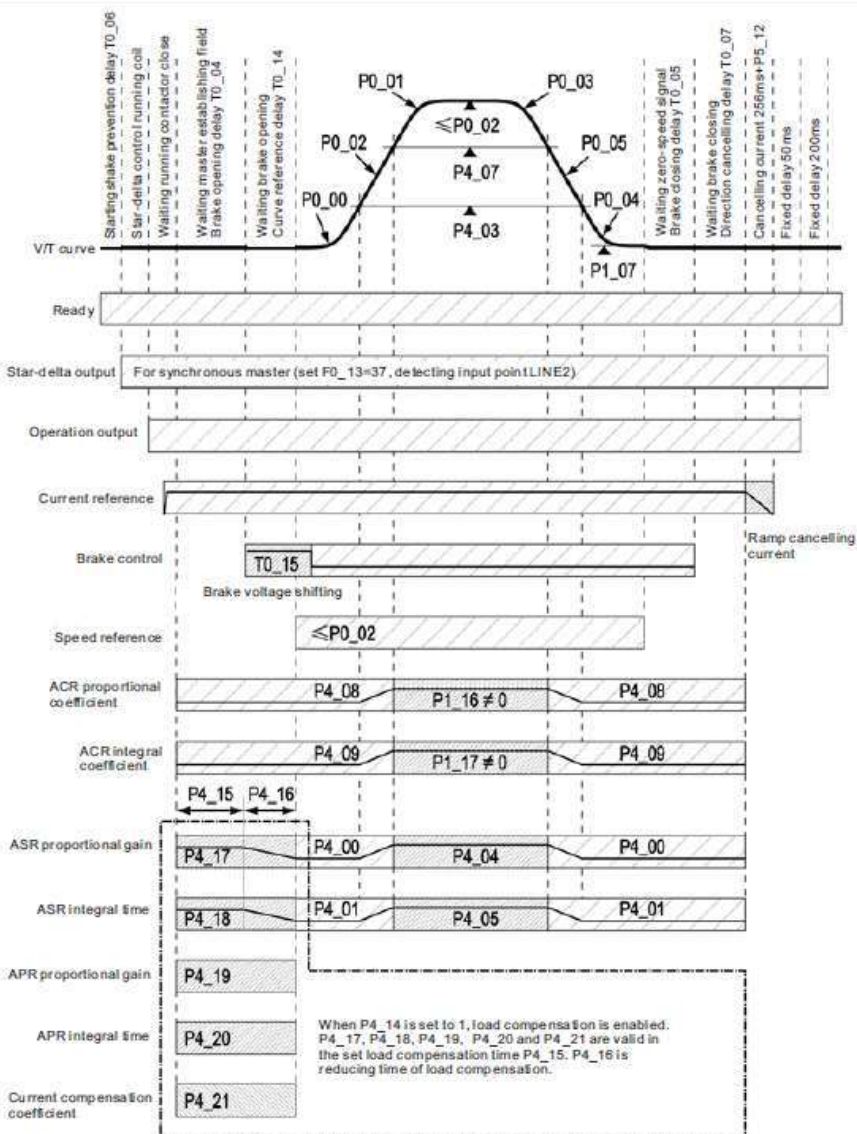

Fig 8-2 Sequence diagram

### 8.9.2 Adjustment of non-weighing compensation starting

1. Set P4\_14 to be 1, in the time set by P4\_15, P4\_17, P4\_18, P4\_19, P4\_20 and P4\_21 are valid.
2. P4\_16 is the transition time from speed loop zero speed (load compensation) to the low speed.
3. If the motor shocks in starting, increase P4\_18 or P4\_21.
4. If the elevator slides in starting, reduce P4\_18 or increase P4\_17. Increase P4\_21 when adjust the load compensation speed loop to eliminate the vibration.
5. No need to set position loop parameters. Too high P4\_19 may cause motor vibration.

### 8.9.3 Adjustment of the speed loop

Speed loop PI has a close relationship with the inertia of the system. Setting the proportional gain and integral time can adjust the dynamic response of the speed loop in vector control. Increasing the proportional gain or decreasing the integral time can speed up the dynamic response of the speed loop. However, too large proportional gain or too small integral time may easily cause oscillation to the system or overadjustment. Too small proportional gain may easily cause steady oscillation to the system and speed static error.

Shifting of the speed loop gain: when the running frequency is below P4\_03, select P4\_00 and P4\_01; if the running frequency is above P4\_07, select P4\_04 and P4\_05; if the running frequency is between P4\_03 and P4\_07, select through the linear change of the parameters .

### 8.9.4 Adjustment of the current loop

The adjustment of P4\_08 and P4\_09 has an effect on the dynamic response speed and control performance of the system. Too strong PI parameters may cause high frequency oscillation to output current and motor noise. Too weak PI parameters may cause low speed vibration to the motor.

The factory setting of the current loop meets the needs basically. Reduce P4\_08 and P4\_09 if high frequency noise occurs and increase P4\_08 and P4\_09 if low-speed vibration occurs.

P4\_08 is increasing with the sudden inductance of the motor and 4\_09 is increasing with the resistance of the rotor.



- ◆ After setting P1\_16/17 to non-zero, enable current loop switching. Generally, the parameter needs no setting. The low/high speed has different characteristics when the master changes with load, and then current loop switching can be enabled (0: disabled).
- ◆ After enabling current loop switching, set P4\_08/09 to low-speed current loop proportion and integral, P1\_16/17 to high-speed current loop proportion and integral.

### 8.9.5 Motor noise

Check and adjust P0\_07 (6kHz), P4\_08, P4\_09 and P4\_10 if the motor has noise in running.

When the asynchronous motor is running, increase slip corresponding to load direction properly if output voltage cause master noise.

### 8.9.6 Relative parameters

Fast running state	Relative parameters
Slide at the heavy side when starting	For the synchronous motor, enable P4_14, set P4_15, reduce P4_18 and increase P4_17 (if there is noise after increase, adjust P4_21: -1000~+4000). Additionally, it is considerable to increase P4_00.
Starting shock	Increase P4_18 and reduce P4_17 (for slide, adjust P4_21).
Rapid acceleration and deceleration	Reduce P1_02 and P1_05. Note: The ratio of acceleration and increasing acceleration does not exceed 3, neither does the ratio of deceleration and reducing deceleration.
Vibration during acceleration and deceleration	Adjust P4_03, P4_07 and narrow the gap between high and low speed loop gain
Shock acceleration and deceleration at the end	Adjust P1_01 and P1_04
Stopping vibration	Reduce P4_00 or enable current loop switching, reduce P4_08, P4_09 and increase P1_16, P1_17
Slide at the heavy side when stopping	Increase P4_00 and T0_07
Slide at the running side when stopping	Increase P4_00 (if there is noise, adjust low-speed integral time to 0.1s), and reduce torque compensation of current loop filter coefficient bit0~bit2 (not exceed 3)
Low-speed vibration	Adjust P4_00, P4_01 and increase P4_08, P4_09
High-speed vibration	Adjust P4_04 and P4_05
Entire running shock	Adjust P4_08, P4_09, P4_02, P4_06 (not exceed 3) and P4_10



- ◆ When the elevator changes with load, the characteristics changes (for example, normal at LL while noise and resonance at FL). Enable current loop switching and set P4\_08/P4\_09 to low-speed current loop proportion and integral, P1\_16/P1\_17 to high-speed current loop proportion and integral.



### 8.9.7 Adjustment of weighing compensation

When the synchronous master adopts UVW encoder or pulley drives the asynchronous motor, the device for weighing compensation will be necessary. If it is installed at the rope end of the engine room, the compensation signal will be connected to AI1 and GND of EC160 main board, P4\_24=2. If it is installed on the weighing proximity switch at the car bottom, P4\_24=1.

	<p>◆ When OL voltage&gt;FL voltage&gt;LL voltage, set F0_17 bit1 to 1, that is, +2 on the original parameter.</p>
---	---

If the OL and FL signals of the elevator adopt analog weighing voltage of car top board, EC160 autotuning at LL, FL and OL in sequence will be needed, as shown below:

1. Fix the weighing sensor approaching to the center of the bottom and place it in horizontal, about 20mm from the car bottom;
2. Set P4\_23 to 1, P4\_24 to 1;
3. In inspection, keep the car at light load, adjust the position of the sensor, and input voltage about 8V to car top board (monitor by checking analog input voltage of U1\_32)
4. Enter into following setting interface. Data will be saved after finishing autotuning in sequence.

**【main menu】**

- A system control
- B fault record
- C language selection
- D parameters setting inquiry
- E password setting
- F system autotuning**
- G data management
- H system information



**【system autotuning】**

- [1] hoistway information autotuning
- [2] motor rotating autotuning
- [3] motor static autotuning
- [4] LL weighing autotuning
- [5] FL weighing autotuning
- [6] OL weighing autotuning



**【LL weighing autotuning】**

Whether in the inspection state?

[Y]    [N]

Select [Yes] to press confirm button

**【LL weighing autotuning】**

Please confirm the

Select [Yes] to press confirm button

**【LL weighing autotuning】**

In autotuning

Select [Yes] to press confirm button

**【LL weighing autotuning】**

Autotuning succeeded

A screenshot of a terminal window with a grey background. The text 'autotuning?' is displayed in white.

A screenshot of a terminal window with a grey background. The text '[Y] [N]' is displayed in white.

A screenshot of a terminal window with a grey background. The text 'Load 08.2V' is displayed in white.

After the autotuning succeeded, set P4\_25, P4\_26 and P4\_27 to start compensation adjustment. Set P4\_25 to the analog voltage when the load of the elevator is balanced. For example, when the load of the elevator is balanced, the analog voltage in drive monitoring is 4V and thus the value need to be 40.0%;

When the drive is in the electromotion state, adjust P4\_26. Increase compensation if not enough and decrease it if too high.

When the drive is in the power generation state, adjust P4\_27. Increase compensation if not enough and decrease it if too high.

## Chapter 9 Complete product description

### 9.1 Instruction of EC-CTB

EC-CTB is the main control board of EC160, including 9 digital signal inputs, 1 analog voltage signal input, 5 relay normally-open signal outputs and 1 relay normally-open/closed signal output. It also has 2 digital signal I/O terminals to communicate with EC-CCB, the terminals to carry on CAN communication for EC160 and the displaying board in car, and RS485 communication with upper computer. It is important for the signal collection and output of EC160 controller.

#### 9.1.1 Installation dimension

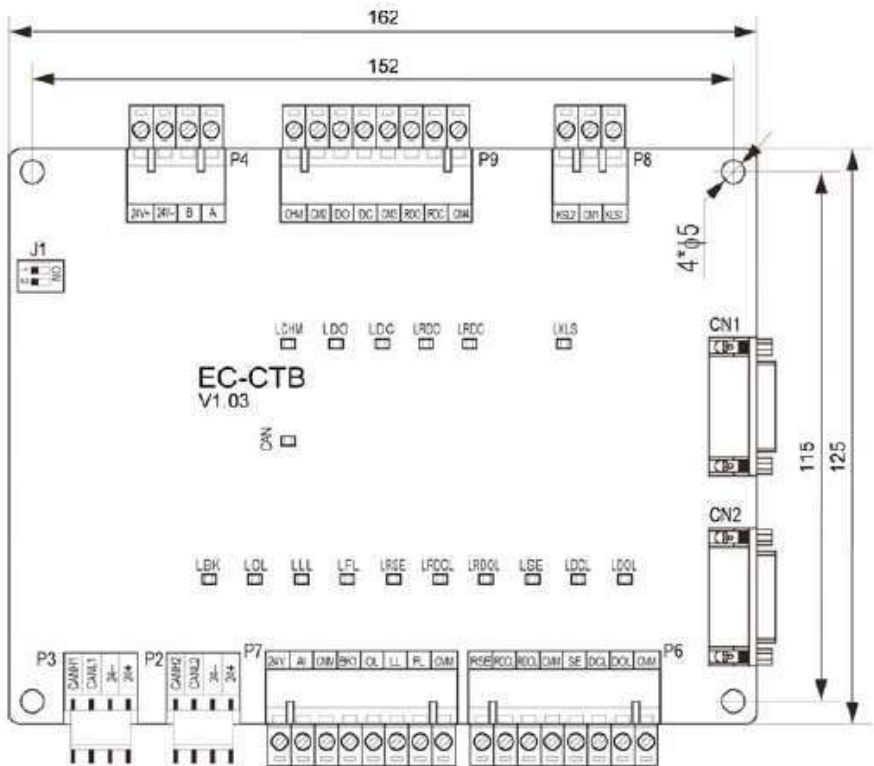

Figure 9-1 Installation dimension of EC-CTB

Installation method:

1. Install when all power supplies are disconnected.
2. Fix with screws according to the installation holes.
3. Connect the terminals and tighten up.

### 9.1.2 Interface definition

Serial No.	Pin	Code	Terminal definition
1	P1	4-core terminal	Download port of J-link
2	P2	CANH1, CANL1, 24-, 24+	CAN communication interface
3	P3	CANH2, CANL2, 24-, 24+	CAN communication interface
4	P4	24V+, 24V-, B, A	RS485 communication interface
5	P5	8-core terminal	Download port of serial software
6	P6	RSE, RDCL, RDOL, CMM; SE, DCL, DL, DOL, CMM;	Rear door beam, close/open signal of rear door Front door beam, close/open signal of front door
7	P7	24V, AI, CMM; BK1, OL, LL, FL, CMM;	24V and CMM provide DC24 power; AI and CMM are 0~10V input; BK1 is the spare input; OL is the overload input; LL is the light load input and FL is the full load input
8	P8	KLS1, CM1, KSL2;	KLS1 and CM1 are the NC contact of energy control; KLS2 and CM1 are the NO contact of energy control
9	P9	CHM, CM2, DO, DC, CM3, RDO, RDC, CM4;	CHM and CM2 are the arrival control; DO, DC and CM3 are the front door open/close control; RDO, RDC and CM4 are the rear door open/close control
10	CN1	DB9 (female)	CN1 port connects the internal command board
11	CN2	DB9 (female)	CN1 port connects the internal command board (for the command button of the rear door)

### 9.1.3 DIP instruction

No.	Bit	Function
J1	1	Switch to "ON" when use external protocol. Switch to "OFF" in factory.
	2	Switch to "ON" and the terminal resistor is valid. Switch to "OFF" in factory.

	<ul style="list-style-type: none"> <li>◆ It is recommended to use shield cables for the avoidance of interference. Avoid parallel cable routine.</li> <li>◆ Use 9-core cables to connect the car board and command board.</li> <li>◆ It is better to use shield cables as the communication wires.</li> <li>◆ Connect the terminal as designated as tight as enough.</li> </ul>
---	---

### 9.1.4 Settings of configuration

Serial No.	Door operator and control box configuration	BK1 terminal	DOD, PAS (F0.09=0)
1	Single control box and single door operator	Not connect	F0.15=11, DOD and PAS can be the light of opening delay button
2	Single control box and dual door operator	Not connect	F0.15=1, DOD is the opening light of rear door. Connect 4 pins of J19-DOD to 4 pins of J17, and PAS is the light of opening delay button
3	Dual control box and single door operator	Short circuit CMM	The buttons and lights of two control boxes can be coped with in the same way.
4	Dual control box and dual door operator	Not connect	DOD and PAS of front door can be multi-function output.

## 9.2 Instruction of EC-CCB

EC-CCB is the auxiliary command board in the controller of EC160. Each board has 24 input and 22 output terminals, including 16 floor buttons and 8 function signals. It is mainly used for the signal collection and output of buttons and lights. The cascade connection can meet the needs of 64 floors and the parallel connection can meet the needs of main and sub control boxes in the car.

### 9.2.1 Installation dimension

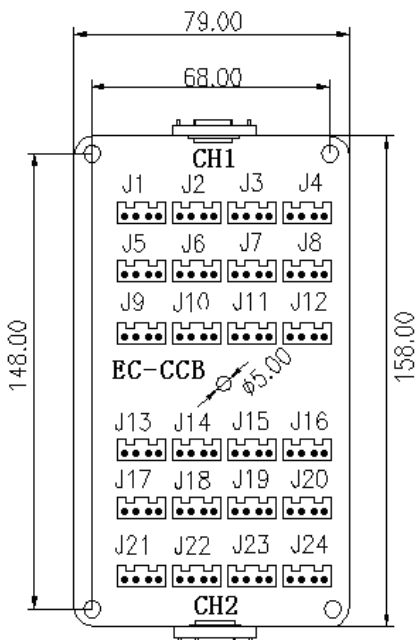



Figure 9-2 Installation dimension

### 9.2.2 Interface definition

Serial No.	Pin	Code	Terminal definition	Remarks
1	CH1	DB9 (male)	CH1 connects the car top board	
2	CH2	DB9 (female)	CH2 connects the internal command board	
3	J1	V+, K, V+, L-	Button input of floor 1 (see Fig9-3)	For command board 2, Jn input signal corresponds
4	J2	V+, K, V+, L-	Button input of floor 2	
5	J3	V+, K, V+, L-	Button input of floor 3	
6	J4	V+, K, V+, L-	Button input of floor 4	
7	J5	V+, K, V+, L-	Button input of floor 5	
8	J6	V+, K, V+, L-	Button input of floor 6	
9	J7	V+, K, V+, L-	Button input of floor 7	

Serial No.	Pin	Code	Terminal definition	Remarks
10	J8	V+, K, V+, L-	Button input of floor 8	to the input of (16+n) button <b>The 2<sup>nd</sup> board can expand 20 floor commands</b>
11	J9	V+, K, V+, L-	Button input of floor 9	
12	J10	V+, K, V+, L-	Button input of floor 10	
13	J11	V+, K, V+, L-	Button input of floor 11	
14	J12	V+, K, V+, L-	Button input of floor 12	
15	J13	V+, K, V+, L-	Button input of floor 13	
16	J14	V+, K, V+, L-	Button input of floor 14	
17	J15	V+, K, V+, L-	Button input of floor 15	
18	J16	V+, K, V+, L-	Button input of floor 16	
19	J17/OBL	V+, K, V+, L-	Button input of door open (see Fig9-4)	
20	J18/CBL	V+, K, V+, L-	Button input of door close (see Fig9-5)	
21	J19/DOD	V+, K, V+, L-	Button input of door open delay	
22	J20/PAS	V+, K, V+, L-	Button input of drive	
23	J21/ATT	V+, K, null, null	Button input of attendant	
24	J22/DS	V+, K, null, null	Button input of direction change	
25	J23/IND	V+, K, null, null	Button input of separate running	
26	J24/FRCL	V+, K, null, null	Button input of fire switch	

	<ul style="list-style-type: none"> <li>◆ It is recommended to use shield cables for the avoidance of interference. Avoid parallel cable routine.</li> <li>◆ Use 9-core cables to connect the car board and command board.</li> <li>◆ Connect the terminal as designated as tight as enough.</li> </ul>
---	--

**9.2.3 Car command button and connection of the indicators**

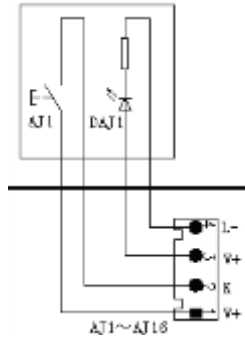

Figure 9-3 Car command button and connection of the indicators

**9.2.4 Car open button and connection of the indicators**

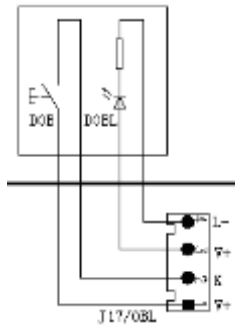

Figure 9-4 Car open button and connection of the indicators

**9.2.5 Car close button and connection of the indicators**

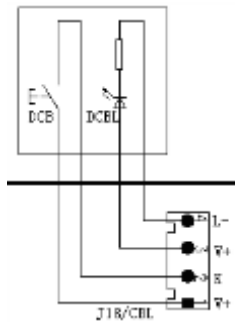

Figure 9-5 Car close button and connection of the indicators



### 9.3 Instruction of DC-03F

DC-03F is one of the important interfaces for the interaction between the passengers and the control system. The displaying board can receive the calling and display the current floor and the running direction of the elevator. The floor displaying board can be also used as the displaying board in the car.

Although there are various models for the displaying board, the most common is DC-03F (ultra-thin dot matrix displaying board, red, 144x70x10, unit:mm). If our displaying board cannot meet the needs of customers, use DC-03Z to match with the displaying board of customers. For more details, contact with our company.

#### 9.3.1 Installation dimension

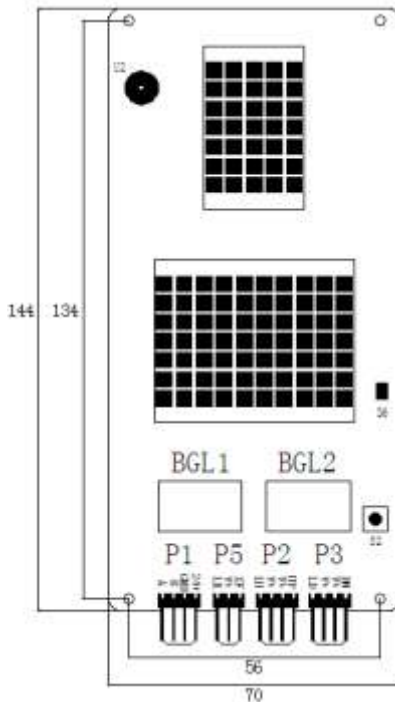

Figure 9-6 Installation dimension



**Caution**

- ◆ The floor of the calling board cannot be set to 0.
- ◆ It is recommended to use shield cables for the avoidance of

	interference. ◆ Connect as the designated as tight as enough.
--	--

### 9.3.2 Interface definition

Serial No.	Code	Terminal definition	Function
1	P1	A, B, GND, 24+	Power input and RS485 communication bus interface
2	P2	LU, V+, V+, UP-	Up calling button and recording light
3	P3	LD, V+, V+, DN	Down calling button and recording light
4	P5	LK, V+, XF	Lock signal and fire signal
5	D6	Running communication indicator	Off when normal communication Flickering when no communication
7	P6	Program download port	Download port of serial port
8	S1	Across terminal of the communication terminator	Short circuit the corresponding S1 of the outside calling displaying board at the bottom floor and the displaying board in the car
9	S2	Parameters setting button	Long press _ enter into menu setting interface (floor displaying interface→ menu setting interface), short press _ shift the menu interface, long press _ save the set parameters in the menu setting interface and exit the floor displaying interface (menu setting interface→floor displaying interface)

### 9.3.3 Terminal connection of DC-03F

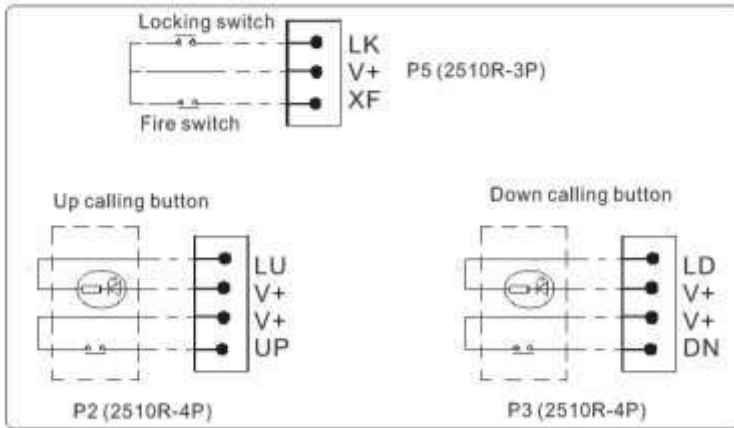

Figure 9-7 Switch connection of the calling displaying board

### 9.3.4 Parameters setting of DC-03F

#### 9.3.4.1 Table of parameters

Code	Definition	Default value
K	Address of the displaying board, range: 0~64	0
H	Function selection: lock enabling, fire enabling and arrow selection	0
G	Spare parameter	0

#### 9.3.4.2 Address setting of the hall displaying board

If the hall displaying board is DC-03F, set the value of 'K' to correspond to the floor number. That is, the K value of the bottom floor is 1 and the maximum cannot exceed 64.

When the button control of the back and front door is applied, the address of DC-03F board starts from K=33 and the maximum address can not exceed 64.

### 9.3.5 Function setting of the displaying board

#### 9.3.5.1 Definition of 'H'

'H' is a hex data composing of 8 binaries. 4 low bit can be transformed into low hex bit and 4 high bit can be transformed into high hex bit. Below are the definitions:

Data (X stands for : 0 or 1)								Definition
7	6	5	4	3	2	1	0	
X	X	X	X	X	X	X	1	Lock enabling, the lock signal act when the 0 position is 1
X	X	X	X	X	X	1	X	Fire enabling, the fire signal act when the 0 position is 1
X	X	X	X	X	1	X	X	Arrow enabling, the arrow displays the state when the 2 position is 1
X	X	X	X	1	X	X	X	Inspection displaying enabling, the inspection state displays JX when the 3 position is 1
X	X	X	1	X	X	X	X	Calling enabling of rear door, the rear door board displays when the 4 position is 1
1	X	X	X	X	X	X	X	Fire calling displaying selection, the calling has no display at fire when the 7 position is 1

### 9.3.5.2 Lock enabling setting

Set lock enabling to be '1', the elevator is running automatically and when the lock signal closes, the floor displaying outside the elevator is off, but the displaying in car is normal. When the elevator returns to the stopping floor and the door is closed, the elevator is locked.

### 9.3.5.3 Fire enabling setting

Set the fire safety enabling to be '1', when the fire signal is off and the elevator is running, the elevator will be in the fire running state.

Note: The lock enabling and fire enabling is only one valid at the outside calling controller of the elevator, but the lock enabling and fire enabling can be set on different outside calling controller.

### 9.3.5.4 Arrow enabling setting

Set the arrow enabling to be '1', then the elevator will display in thin rolling arrow; set the arrow enabling to be '0', then the elevator will display in thick rolling arrow.

### 9.3.6 Displaying table of elevator state







Displaying in the car				
Station prediction: no				
Inspection	<input checked="" type="checkbox"/> normal displaying	<input type="checkbox"/> no displaying	<input type="checkbox"/> special characters or other mode	Display floor number and leveling mark when inspection in leveling; Display floor number when inspection not in leveling
Power off Leveling	<input checked="" type="checkbox"/> normal displaying	<input type="checkbox"/> no displaying	<input type="checkbox"/> special characters or other mode	
Independent	<input checked="" type="checkbox"/> normal displaying	<input type="checkbox"/> no displaying	<input type="checkbox"/> special characters or other mode	
Fire	<input checked="" type="checkbox"/> normal displaying	<input type="checkbox"/> no displaying	<input type="checkbox"/> special characters or other mode	
Safety circuit off	<input checked="" type="checkbox"/> normal displaying	<input type="checkbox"/> no displaying	<input type="checkbox"/> special characters or other mode	
Lock	<input type="checkbox"/> normal displaying	<input type="checkbox"/> no displaying	<input checked="" type="checkbox"/> special characters or other mode	
Fault	<input type="checkbox"/> normal displaying	<input type="checkbox"/> no displaying	<input checked="" type="checkbox"/> special characters or other mode	
Overload	<input type="checkbox"/> normal displaying	<input type="checkbox"/> no displaying	<input checked="" type="checkbox"/> special characters or other mode	Display "OL"
Attendant	<input checked="" type="checkbox"/> normal displaying	<input type="checkbox"/> no displaying	<input type="checkbox"/> special characters or other mode	
Full load	<input checked="" type="checkbox"/> normal displaying	<input type="checkbox"/> no displaying	<input type="checkbox"/> special characters or other mode	

Displaying outside the hall				
Station prediction: yes				
Inspection	<input type="checkbox"/> normal displaying	<input type="checkbox"/> no displaying	<input checked="" type="checkbox"/> special characters or other mode	
Power off Leveling	<input checked="" type="checkbox"/> normal displaying	<input type="checkbox"/> no displaying	<input checked="" type="checkbox"/> special characters or other mode	

Independent	<input type="checkbox"/> normal displaying	<input checked="" type="checkbox"/> no displaying	<input type="checkbox"/> special characters or other mode	1[F], 2/3 normal displaying
Fire	<input checked="" type="checkbox"/> normal displaying	<input type="checkbox"/> no displaying	<input type="checkbox"/> special characters or other mode	Optional
Safety circuit off	<input checked="" type="checkbox"/> normal displaying	<input type="checkbox"/> no displaying	<input type="checkbox"/> special characters or other mode	
Lock	<input type="checkbox"/> normal displaying	<input checked="" type="checkbox"/> no displaying	<input type="checkbox"/> special characters or other mode	
Fault	<input type="checkbox"/> normal displaying	<input checked="" type="checkbox"/> no displaying	<input type="checkbox"/> special characters or other mode	
Overload	<input checked="" type="checkbox"/> normal displaying	<input type="checkbox"/> no displaying	<input type="checkbox"/> special characters or other mode	
Attendant	<input checked="" type="checkbox"/> normal displaying	<input type="checkbox"/> no displaying	<input type="checkbox"/> special characters or other mode	
Full load	<input type="checkbox"/> normal displaying	<input type="checkbox"/> no displaying	<input checked="" type="checkbox"/> special characters or other mode	1[F], 2/3 normal displaying

**9.3.7 Displaying pictures**

Serial No.	Picture	Meaning
1		Displaying in the inspection car "=" means the elevator is in the leveling position of 12 <sup>th</sup> floor
2		Displaying outside the car means the inspection state
3		Displaying outside the car "F" means the elevator is full running
4		Monitor inside the car "OL" means overload

Serial No.	Picture	Meaning
5		Up arrow means the elevator is going to go up. Rolling arrow means the elevator is going up. The quicker the rolling speed is, the faster the elevator is running.
6		Down arrow means the elevator is going to go down. Rolling arrow means the elevator is going down. The quicker the rolling speed is, the faster the elevator is running.
7		The monitor is in the state of floor setting.
8		The monitor is in the state of multi-function displaying.
9		"V" means the version of the elevator. 12 means version 1.2. Display when power on.
10		The elevator is locked.

#### 9.4 Instruction of MC-GCL

The group control board MC-GCL and elevator intelligent integrated EC160 make up the distributed control system DCS. By CAN communication, collect internal/external calling recording signals of each elevator. After intelligent processing, allocate the information to corresponding elevator to control 8~64 elevators under high efficiency. Functions of DCS are:

1. Adaptive up in rush hour: when the group control board identifies rush hours, all elevators will provide service according to up calling priority. After rush hours, change into balanced mode automatically.
2. Adaptive down in rush hour: when the group control board identifies rush hours, one elevator will provide service for up calling and other elevators will provide service for down calling, responding to down calling as soon as possible. After rush hours, change into balanced mode automatically.
3. Timing up in rush hour: in the set time, all elevators provide service according to up calling

priority.

4. Timing down in rush hour: in the set time, all elevators provide service according to down calling priority.

5. Timing zoning running: in the set time, the specified elevators will only stop at allocated floors and prompt passengers by sound and light according to setting, achieving high speed, efficiency and reducing stop as much as possible.

6. Balanced mode: respond to the calling command according to the shortest time

7. Free mode: in balanced mode, when there is no calling in the set time, elevators will wait for commands at the 1<sup>st</sup> floor in the specified zone to respond to calling as fast as possible.

MC-GCL adopts 32-bit ARM chip, four layers mounted at the surface and CAN bus serial communication, highly intelligent and reliable. It also has the manual keypad for operation and LCD interface for debugging.

#### 9.4.1 Installation dimension

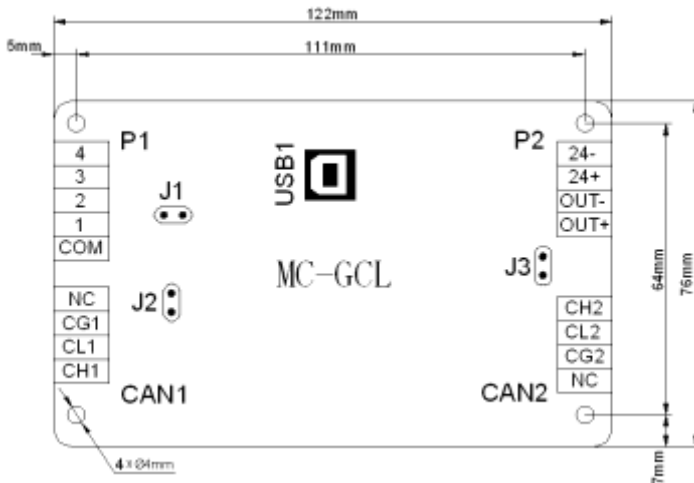

Figure 9-8 Installation dimension

Installation method:

1. Install when all power supplies are disconnected.
2. Fix with screws according to the installation holes.
3. Connect the terminals and tighten up.

#### 9.4.2 Configuration



Name	Function	Qty.	Position
MC-GCL	For group control	One for each elevator	In control cabinet

#### 9.4.3 Specification of the connectors

Serial No.	No.	Model
1	CAN1, CAN2, P2	2EHDR-4P
2	P1	2EHDR-5P
3	J1, J2, J3	SIP2 (pin 2.54mm)
4	CN1	180° B USB female

#### 9.4.4 Electrical specifications

##### 9.4.4.1 Board specifications

Name	MC-GCL
Color	Blue
Thickness	1.6mm
Layers of layout	4

##### 9.4.4.2 Power supply specifications

Input voltage range	DC22V~DC26V	
	Main board control the chip to run	1.6W
	Optical coupling (4) full input valid	0.6W

##### 9.4.4.3 Low-voltage switch specifications

Input point	4	
Input manner	4 common cathode collector open input	
Input voltage threshold	Absolute turn-on threshold	≤6V
	Absolute turn-off threshold	≥18 V
Recommended valid input voltage	0V	
Max. current	20mA	

##### 9.4.4.4 Communication interface

Interface	Manner	Function
CAN1	CAN BUS	Define group control interface communication along with EC160
CAN2	CAN BUS	Communicate with the group control board

#### 9.4.4.5 Working environment

Temperature	0°~70°
Humidity	<95%
Salt fog	0.13ug/m3
Shock	Peak acceleration speed 100gn, 100 times
Vibration	10Hz-100Hz 50 times 100Hz-10Hz 50 times
Sudden pulse group interference	2.5kV

#### 9.4.5 Definition of the input/output interface

##### 9.4.5.1 Definition of power supply interface

P2 is the interface for working power supply of MC-GCL supplied by external DC24V switch power.

Serial No.	Pin	I/O	Definition	Remarks
P2	24-	Input	DC0V input terminal	
	24+	Input	DC24V+input terminal	
	OUT-	Output	DC0V power supply interface for outside	
	OUT+	Output	DC24V+ power supply interface for outside	

##### 9.4.5.2 Definition of CAN communication interface

CAN1 and CAN2 are CAN communication interfaces and the communication cable must be twisted pairs.

Serial No.	Pin	I/O	Definition	Remarks
CAN1	CH1	Output	Communicate with EC160 H terminal	Twisted pairs for external connection
	CL1	Output	Communicate with EC160 L terminal	
	CG1	Output	Grounding terminal of CAN1	Not grounded generally
	NC	Output	Not connected	
CAN2	CH2	Output	Communicate with MC-GCL H terminal	Twisted pairs for external connection
	CL2	Output	Communicate with MC-GCL L terminal	

	CG2	Output	Grounding terminal of CAN2	Not grounded generally
	NC	Output	Not connected	

#### 9.4.5.3 Definition of I/O terminal

Serial No.	Pin	I/O	Definition	Corresponding LED
P1	COM	Input	1, 2, 3 and 4 pins input common terminal	—
	1	Input	Not defined	L4
	2	Input	Not defined	L3
	3	Input	Not defined	L2
	4	Input	Not defined	L1

#### 9.4.6 Definition of jumper terminal

Serial No.	Definition of pin	Remarks
J1	Short circuit the connector in serial download software mode	Not short circuit
J2	Short circuit pin between group control board and CAN communication terminal resistance defined on EC160-I/O board; in short circuit, resistance about 120Ω, if not, communication resistance open circuit	Default short circuit
J3	Short circuit pin between group control board and CAN communication terminal resistance; in short circuit, resistance about 120Ω, if not, communication resistance open circuit	Default short circuit; on site, 2 farthest J3 need short circuit while other J3 unnecessary.

#### 9.4.7 Instruction of LED

Name	Instruction
LED1	When no communication is at CAN1, LED1 will be on at the interval of 0.5s; when communication at CAN1 is normal, LED1 will flicker continuously.
LED2	When no communication is at CAN1, LED2 will be off; when communication at CAN1 is normal, LED2 will flicker continuously.
LED3	When no communication is at CAN2, group number is 3 (No.1 elevator) and LED3 is on at the interval of 0.5s; when communication at CAN2 is normal, group number

Name	Instruction
	is 3 (No.1 elevator) and LED3 flickers continuously (in group control dispatch).
LED4	When no communication is at CAN2, group number is 4 (No.2 elevator) and LED4 is on at the interval of 0.5s; when communication at CAN2 is normal, group number is 4 (No.2 elevator) and LED4 flickers continuously (in group control dispatch).
LED5	When no communication is at CAN2, group number is 5 (No.3 elevator) and LED5 is on at the interval of 0.5s; when communication at CAN2 is normal, group number is 5 (No.3 elevator) and LED5 flickers continuously (in group control dispatch).
LED6	When no communication is at CAN2, group number is 6 (No.4 elevator) and LED6 is on at the interval of 0.5s; when communication at CAN2 is normal, group number is 6 (No.4 elevator) and LED6 flickers continuously (in group control dispatch).
LED7	When no communication is at CAN2, group number is 7 (No.5 elevator) and LED7 is on at the interval of 0.5s; when communication at CAN2 is normal, group number is 7 (No.5 elevator) and LED7 flickers continuously (in group control dispatch).
LED8	When no communication is at CAN2, group number is 8 (No.6 elevator) and LED8 is on at the interval of 0.5s; when communication at CAN2 is normal, group number is 8 (No.6 elevator) and LED8 flickers continuously (in group control dispatch).

Note: When communication at CAN1 is normal, LED3-8 off, please check:

1. Whether the group number is correct, L0=3-10
2. Whether the number of group control boards is more than 8

**9.4.8 Diagram of communication interface**

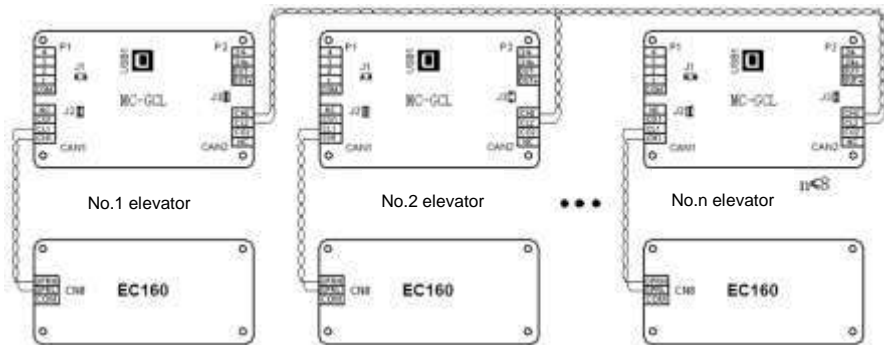

Figure 9-9 Diagram of GCL CAN communication interface

Precautions for wiring and debugging:

1. CL1 and CH1 of MC-GCL should be connected to GPRL and GPRH of EC160 in No.1 elevator,

and so on;

2. All CL2 and CH2 of MC-GCL are in parallel connection;
3. The total number of MC-GCL is no more than 8;
4. Short circuit all J2 of MC-GCL; short circuit J3 between No.1 and No. n elevator while disconnect J3 pins in other elevators;
5. No.1 elevator: MC-GCL is connected to EC160 (group number L0=3), No.2 elevator: MC-GCL is connected to EC160 (group number L0=4), and so on...No.8 elevator: MC-GCL is connected to EC160 (group number L0=10).

### 9.4.9 Debugging

#### 9.4.9.1 Connection between MC-GCL and manual controller

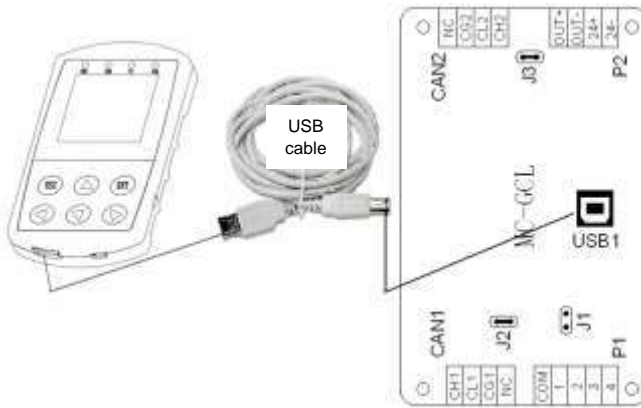

Figure 9-10 Connection of MC-GCL and manual controller

#### 9.4.9.2 Initial debugging interface

【monitoring  
password input】  
00000000

【main menu】

- A system control
- B fault record
- C language selection
- D parameters setting inquiry
- E password setting
- F system autotuning
- G data management
- H system information

The monitoring password can only enter into A, B and H in the main menu and they are only for read. After inputting the monitoring password, pressing ESC can shift into the password debugging or factory password input mode.



The original value of monitoring password and debugging password is 00000000.

If it is necessary to shift into the other modes after password entering, power off and enter again.

**9.4.9.3 System monitoring---calling and running state**

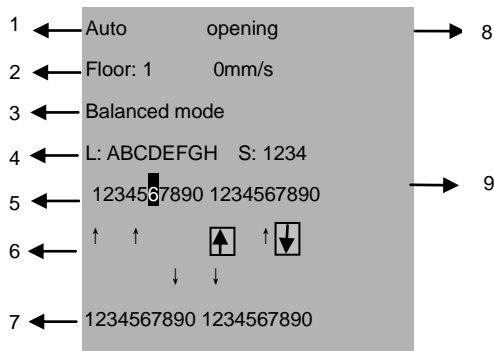
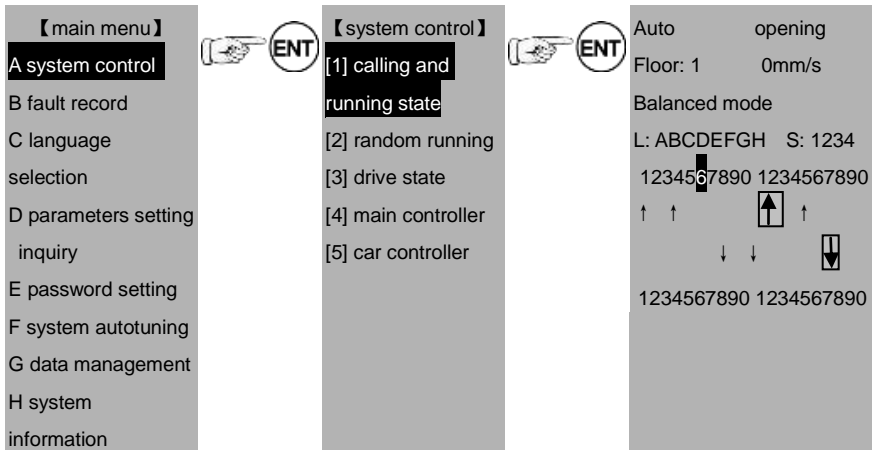

Serial No.	Meaning
1	Elevator state: automatic, inspection and group control
2	Current floor and running speed
3	Current mode
4	The highlight is the number involved in group control dispatch
5	Monitor recorded car command
6	Recorded up calling command (the arrow box means assigning the up command of the elevator)
7	Recorded down calling command (the arrow box means assigning the down command of the elevator)
8	Door state: opening, closing, open and closed
9	The highlight is the state of input point

**9.4.9.4 Parameters setting inquiry**

Move the cursor into D after entering into the main menu and press ENT into the parameters setting; the main menu is as below:

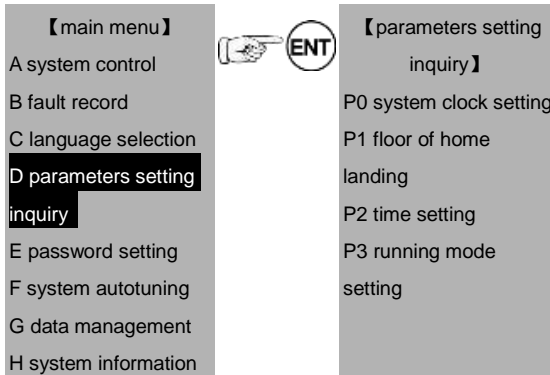

**9.4.9.5 Parameters setting inquiry---system clock setting**

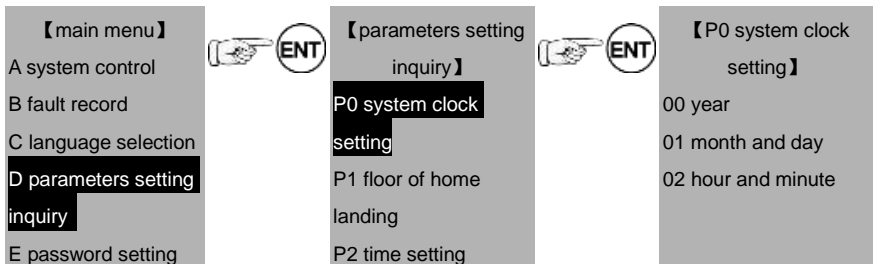

F system autotuning  
 G data management  
 H system information

P3 running mode setting



Function code	Description	Setting range 【default value】	Remarks
P0_00	Year	2000~2099 【2010】	Bottom floor by default
P0_01	Month and day	01.01~12.31 【01.01】	
P0_02	Hour and minute	00.00~23.59 【12.00】	

9.4.9.6 Parameters setting inquiry---floor of home landing

<p>【main menu】</p> <p>A system control</p> <p>B fault record</p> <p>C language selection</p> <p><b>D parameters setting inquiry</b></p> <p>E password setting</p> <p>F system autotuning</p> <p>G data management</p> <p>H system information</p>		<p>【parameters setting inquiry】</p> <p>P0 system clock setting</p> <p><b>P1 floor of home landing</b></p> <p>P2 time setting</p> <p>P3 running mode setting</p>		<p>【P1 floor of home landing】</p> <p>00 home landing at bottom</p> <p>01 home landing in middle</p> <p>02 home landing at top</p> <p>03 group control home landing 4</p> <p>04 group control home landing 5</p> <p>05 group control home landing 6</p> <p>06 group control home landing 7</p> <p>07 group control home landing 8</p> <p>08 VIP floor</p>
---	--	---	--	--

Function code	Description	Setting range 【default value】	Remarks
P1_00	Home landing at bottom	00~64 【01】	Default floor is at the bottom



Standby floor in rush hour up; separate standby-elevator A returns to standby floor (P2_03=0, the function is invalid)			
P1_01	Home landing in middle	00~64 【00】	Default floor is in the middle
Separate standby-elevator B returns to standby floor (P2_03=0, the function is invalid)			
P1_02	Home landing at top	00~64 【64】	Default floor is at the top
Standby floor in rush hour down; separate standby-elevator C returns to standby floor (P2_03=0, the function is invalid)			
P1_03	Group control home landing 4	00~64 【00】	
Separate standby-elevator D returns to standby floor (P2_03=0, the function is invalid)			
P1_04	Group control home landing 5	00~64 【00】	
Separate standby-elevator E returns to standby floor (P2_03=0, the function is invalid)			
P1_05	Group control home landing 6	00~64 【00】	
Separate standby-elevator F returns to standby floor (P2_03=0, the function is invalid)			
P1_06	Group control home landing 7	00~64 【00】	
Separate standby-elevator G returns to standby floor (P2_03=0, the function is invalid)			
P1_07	Group control home landing 8	00~64 【00】	
Separate standby-elevator H returns to standby floor (P2_03=0, the function is invalid)			
P1_08	VIP floor	00~64 【00】	

9.4.9.7 Parameters setting inquiry---time setting

- 【main menu】
- A system control
- B fault record
- C language selection
- D parameters setting inquiry**
- E password setting
- F system autotuning



- 【parameters setting inquiry】
- P0 system clock setting
- P1 floor of home landing
- P2 time setting**
- P3 running mode



- 【P2 time setting】
- 00 idle time threshold
- 01 time threshold of external selection
- 02 time threshold of internal selection
- 03 time threshold of separate standby



G data management  
H system information

setting

04 T4  
05 T5

Function code	Description	Setting range 【default value】	Remarks
P2_00	Idle time threshold	000.0~600.0 【20】 s	
Note: when the elevator cannot run and timeout, exit group control time.			
P2_01	Time threshold of external selection	00.0~10.0 【2】 s	
Note: time threshold for responding to external selection			
P2_02	Time threshold of internal selection	00.0~10.0 【2】 s	
Note: time threshold for responding to internal selection			
P2_03	Time threshold of separate standby	00000~60000 【0】 s	
Note: separate standby is valid at non-zero-when separate standby time is up without running direction, return to the set standby floor.			
P2_04	Customized	0000.0~6553.5 【45】 s	
Note: error duration that the elevator did not run with direction and timeout			
P2_05	Customized	0000.0~6553.5 【45】 s	
Note: error duration that the elevator had dispatch command without direction (2s)			

9.4.9.8 Parameters setting inquiry---running mode setting

<p>【main menu】</p> <p>A system control</p> <p>B fault record</p> <p>C language selection</p> <p><b>D parameters setting inquiry</b></p> <p>E password setting</p> <p>F system autotuning</p> <p>G data management</p> <p>H system information</p>		<p>【parameters setting inquiry】</p> <p>P0 system clock setting</p> <p>P1 floor of home landing</p> <p>P2 time setting</p> <p><b>P3 running mode setting</b></p>		<p>【P3 running mode setting】</p> <p>00 timing rush hour mode enabling</p> <p>01 start time of up rush hour</p> <p>02 end time of up rush hour</p> <p>03 start time of down rush hour</p> <p>04 end time of down rush hour</p>
---	---	---	---	---

05 auto rush hour mode enabling

06 threshold of auto rush hour

07 running time of auto rush hour

08 reserved

09 zoning mode 1 enabling

10 zoning mode 1 start time

11 zoning mode 1 end time

12 mode 1 floor setting-16

13 mode 1 floor setting-32

14 mode 1 floor setting-48

15 mode 1 floor setting-64

16 zoning mode 2 enabling

17 zoning mode 2 start time

18 zoning mode 2 end time

19 mode 2 floor setting-16

20 mode 2 floor setting-32

21 mode 2 floor setting-48

22 mode 2 floor setting-64

23 zoning mode 3 enabling

24 zoning mode 3 start time

25 zoning mode 3 end time

26 mode 3 floor setting-16

27 mode 3 floor setting-32

28 mode 3 floor setting-48

29 mode 3 floor setting-64

30 MF input setting 1

31 MF input setting 2

32 MF input setting 3

33 MF input setting 4

34 F34

35 F35

Function code	Description	Setting range 【default value】	Remarks
P3_00	Timing rush hour mode enabling	000~127 【0】	
P3_01	Start time of up rush hour	00.00~23.59 【00.00】	
P3_02	End time of up rush hour	00.00~23.59 【00.00】	
P3_03	Start time of down rush hour	00.00~23.59 【00.00】	
P3_04	End time of down rush hour	00.00~23.59 【00.00】	
P3_05	Auto rush hour mode enabling	0~1 【0】	
P3_06	Threshold of auto rush hour	0~9 【2】	
P3_07	Running time of auto rush hour	00000~60000 【3000】 s	
P3_08	Reserved		
P3_09	Zoning mode 1 enabling	000~127 【0】	
P3_10	Zoning mode 1 start time	00.00~23.59 【00.00】	
P3_11	Zoning mode 1 end time	00.00~23.59 【00.00】	
P3_12	Mode 1 floor setting-16	00000~65535 【00000】	
P3_13	Mode 1 floor setting-32	00000~65535 【00000】	
P3_14	Mode 1 floor setting-48	00000~65535 【00000】	
P3_15	Mode 1 floor setting-64	00000~65535 【00000】	
P3_16	Zoning mode 2 enabling	000~127 【0】	
P3_17	Zoning mode 2 start time	00.00~23.59 【00.00】	

P3_18	Zoning mode 2 end time	00.00~23.59 【00.00】	
P3_19	Mode 2 floor setting-16	00000~65535 【00000】	
P3_20	Mode 2 floor setting-32	00000~65535 【00000】	
P3_21	Mode 2 floor setting-48	00000~65535 【00000】	
P3_22	Mode 2 floor setting-64	00000~65535 【00000】	
P3_23	Zoning mode 3 enabling	000~127 【0】	
P3_24	Zoning mode 3 start time	00.00~23.59 【00.00】	
P3_25	Zoning mode 3 end time	00.00~23.59 【00.00】	
P3_26	Mode 3 floor setting-16	00000~65535 【00000】	
P3_27	Mode 3 floor setting-32	00000~65535 【00000】	
P3_28	Mode 3 floor setting-48	00000~65535 【00000】	
P3_29	Mode 3 floor setting-64	00000~65535 【00000】	
P3_30	MF input setting 1	0: None 1: Up rush hour 2: Down rush hour	3: Zoning mode 1 4: Zoning mode 2 5: Zoning mode 3
P3_31	MF input setting 2	0: None 1: Up rush hour 2: Down rush hour	3: Zoning mode 1 4: Zoning mode 2 5: Zoning mode 3
P3_32	MF input setting 3	0: None 1: Up rush hour 2: Down rush hour	3: Zoning mode 1 4: Zoning mode 2 5: Zoning mode 3
P3_33	MF input setting 4	0: None 1: Up rush hour 2: Down rush hour	3: Zoning mode 1 4: Zoning mode 2 5: Zoning mode 3
P3_34	Customized	00000~65535 【00000】	
P3_35	Customized	00000~65535 【1】	

9.4.9.9 Data management

**【 main menu 】**  
 A system control  
 B fault record  
 C language selection



**【 data management 】**  
 [1] data saving of the controller  
 [2] restore to the factory

D parameters setting inquiry	value
E password setting	[3] fault history clearance
F system autotuning	[4] data of the controller to PAD
<b>G data management</b>	[5] PAD data to the controller
H system information	

[1] Data storage of the controller: save the data after changing. If not, the data will restore to the original ones.

[2] Factory setting restore: restore the parameters of the controller to the factory setting.

[3] Fault history clearance: clear the fault history.

[4] Save the controller data to PAD. Note: If it is necessary to save data after power off, enter data saving of the controller and carry out the operation.

[5] Download PAD data to the controller.

**9.4.10 Precautions for separate standby of bias floors**

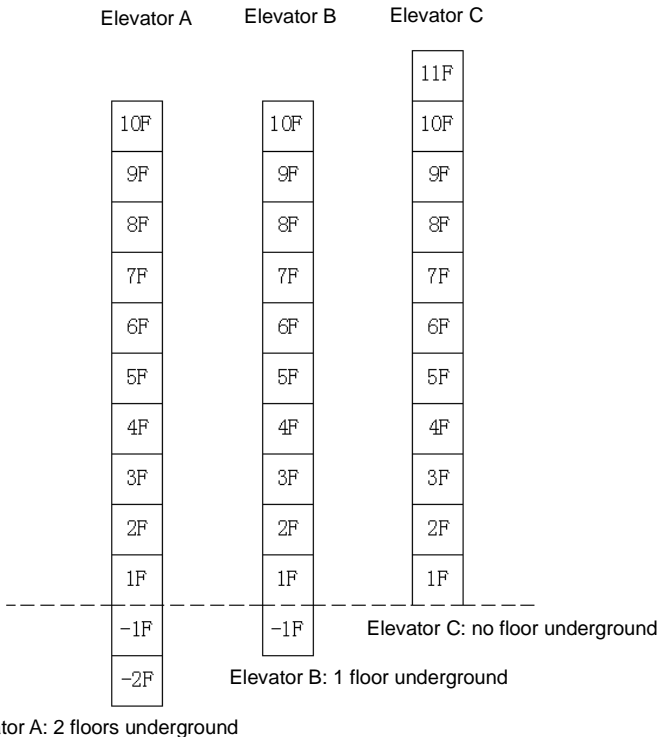

Figure 9-11 Bias floor distribution

Note: Elevator A 10 floors above ground and 2 floors underground; elevator B 10 floors above ground and 1 floor underground; elevator C 11 floors above ground and no floor underground.

#### 9.4.10.1 Precautions for EC160 parameters setting

Elevator A: L0\_00 (group number) =03; L0\_02 (down bias floor) =02; L0\_01 (up bias floor) =00;

Elevator B: L0\_00 (group number) =04; L0\_02 (down bias floor) =01; L0\_01 (up bias floor) =00;

Elevator C: L0\_00 (group number) =05; L0\_02 (down bias floor) =00; L0\_01 (up bias floor) =00;

Note: L0\_01=00 needs no setting for three elevators;

The group control system can calculate the up bias floor of elevator C according to down bias floors and total floors.

#### 9.4.10.2 Precautions for MC-GCL parameters setting

In need of separate standby, elevator A stops at the 1<sup>st</sup> floor, elevator B at the 5<sup>th</sup> floor, and elevator C at the 10<sup>th</sup> floor. The parameters settings are as follows:

Elevator A: P1\_00 (down home landing)=03 (set according to the address of the actual floor); P2\_03 (time threshold of separate standby) ≠0 valid;

Elevator B: P1\_00 (down home landing)=06 (set according to the address of the actual floor); P2\_03 (time threshold of separate standby) ≠0 valid;

Elevator C: P1\_00 (down home landing)=10 (set according to the address of the actual floor); P2\_03 (time threshold of separate standby) ≠0 valid.

### 9.5 Instruction of EC-RDB

EC-RDB which adopts four safety relays with highly reliable design has passed the certification of the elevator safety circuit test.

#### 9.5.1 Installation dimension

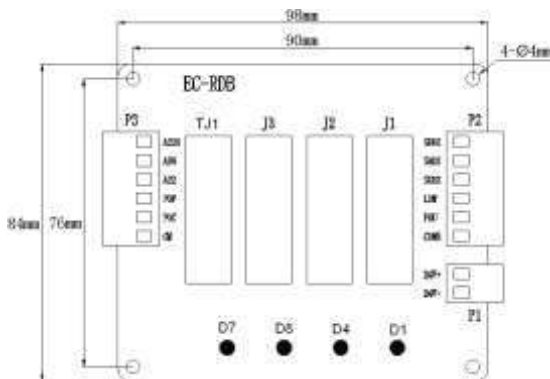

Figure 9-12 Installation dimension of EC-RDB

Installation method:

1. Install when all power supplies are disconnected.
2. Fix with screws according to the installation holes.
3. Connect the terminals and tighten up.

### 9.5.2 Configuration

Name	Function	Qty.	Position
EC-RDB	For opening the door in advance	One for each elevator	In control cabinet

### 9.5.3 Specification of the connectors

No.	Model
P1	2EHDVC-5.08-2
P2, P3	2EHDVC-5.08-6

### 9.5.4 Electrical specifications

#### 9.5.4.1 Board specifications

Name	EC-RDB
Color	Green
Thickness	1.6mm
Layers of layout	2

#### 9.5.4.2 Power supply specification

Input voltage range	DC22V~DC26V
---------------------	-------------

#### 9.5.4.3 Working environment

Temperature	0°~70°
Humidity	<95%
Salt fog	0.13ug/m3
Shock	Peak acceleration speed 100gn, 100 times
Vibration	10Hz-100Hz 50 times 100Hz-10Hz 50 times
Sudden pulse group interference	2.5kV

### 9.5.5 Definition of the input/output interface

#### 9.5.5.1 Definition of P1

Serial No.	Pin	Terminal code	Terminal definition	Remarks
P1	1	24V+	DC24V+ input terminal	



Serial No.	Pin	Terminal code	Terminal definition	Remarks
	2	24V-	DC0V input terminal	

### 9.5.5.2 Definition of P2 and P3

P2: detection input signal

P3: output signal of short circuit lock circuit

Serial No.	Pin	Terminal code	Terminal definition	Remarks
P2	1	SDDZ	Down door area signal	
	2	SMDZ	Medium door area signal	
	3	SUDZ	Up door area signal	
	4	LOW	Low speed signal	
	5	POU	Pre-opening request output terminal	
	6	COM5		
P3	1	A220	Short circuit hall door and car lock circuit	
	2	A30		
	3	A22		
	4	POF	Provide relay adhesion detection point	
	5	POC	Pre-opening/leveling response signal	
	6	CM	Common terminal of switch input signal	

### 9.5.6 Instruction of LED

Name	Instruction
D1	When J1 relay closes, D1 is on.
D4	When J2 relay closes, D4 is on.
D7	When TJ1 relay closes, D7 is on.
D8	When J3 relay closes, D8 is on.

9.5.7 Wiring diagram of EC-RDB and peripheral interface

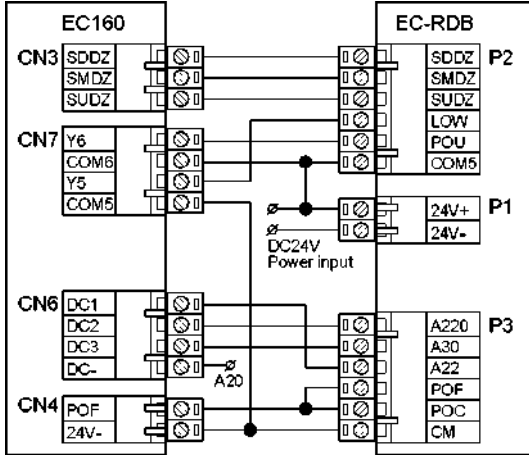

Figure 9-13 Wiring diagram of EC-RDB and peripheral interface

## Chapter 10 Maintenance and hardware diagnosis

### 10.1 Maintenance intervals

If installed in an appropriate environment, the inverter requires very little maintenance. The table lists the routine maintenance intervals recommended by INVT.

Checking		Item	Method	Criterion
Ambient environment		Check the ambient temperature, humidity and vibration and ensure there is no dust, gas, oil fog and water drop.	Visual examination and instrument test	Conforming to the manual
		Ensure there are no tools or other foreign or dangerous objects.	Visual examination	There are no tools or dangerous objects.
Voltage		Ensure the main circuit and control circuit are normal.	Measure with multimeter	Conforming to the manual
Keypad		Ensure the display is clear enough.	Visual examination	The characters are displayed normally.
		Ensure the characters are displayed totally.	Visual examination	Conforming to the manual
Main circuit	For public use	Ensure the screws are tightened.	Tighten up	NA
		Ensure there is no distortion, crackles, damage or color-changing caused by overheating and aging to the machine and insulator.	Visual examination	NA
		Ensure there is no dust and dirtiness.	Visual examination	NA Note: If the color of the copper blocks changes, it does not mean

Checking	Item	Method	Criterion
			that there is something wrong with the features.
	The lead of the conductors	Ensure that there is no distortion or color-changing of the conductors caused by overheating.	Visual examination NA
		Ensure that there are no crackles or color-changing of the protective layers.	Visual examination NA
	Terminals seat	Ensure that there is no damage.	Visual examination NA
	Filter capacitors	Ensure that there is no weeping, color-changing, crackles and chassis expansion.	Visual examination NA
		Ensure the safety valve is in the right place.	Estimate the usage time according to the maintenance or measure the static capacity. NA
		If necessary, measure the static capacity.	Measure the capacity with instrument. The static capacity is above or equal to the original value *0.85.
	Resistors	Ensure whether there is replacement and splitting caused by overheating.	Smelling and visual examination NA
		Ensure that there is no offline.	Visual examination or remove one end to calculate or The resistors are in ±10% of the standard value.

Checking		Item	Method	Criterion
			measure with multimeter	
	Transformers and reactors	Ensure there is no abnormal vibration, noise and smelling.	Hearing, smelling and visual examination	NA
	Electromagnetism contactors and relays	Ensure whether there is vibration noise in the workrooms.	Hearing	NA
		Ensure the contactor is good enough.	Visual examination	NA
Control circuit	PCB and plugs	Ensure there is no loose screws and connectors.	Fasten up	NA
		Ensure there is no smelling and color-changing.	Smelling and visual examination	NA
		Ensure there are no crackles, damage, distortion and rust.	Visual examination	NA
		Ensure there is no weeping and distortion to the capacitors.	Visual examination or estimate the usage time according to the maintenance information	NA
Cooling system	Cooling fan	Estimate whether there is abnormal noise and vibration.	Hearing and visual examination or rotate with hand	Stable rotation
		Estimate there is no loose screws.	Tighten up	NA

Checking		Item	Method	Criterion
		Ensure there is no color-changing caused by overheating.	Visual examination or estimate the usage time according to the maintenance information	NA
	Ventilating duct	Check whether there is stuff or foreign objects in the cooling fan, air inlet and air vent.	Visual examination	NA

## 10.2 Cooling fan

The inverter's cooling fan has a minimum life span of 25,000 operating hours. The actual life span depends on the inverter usage and ambient temperature.

The operating hours can be found through parameters.

Fan failure can be predicted by the increasing noise from the fan bearings. If the inverter is operated in a critical part of a process, fan replacement is recommended once these symptoms appear.

### 10.2.1 Replacing the cooling fan

	<p>◆ Read and follow the instructions in chapter <b>Safety Precautions</b>. Ignoring the instructions would cause physical injury or death, or damage to the equipment.</p>
---	---

1. Stop the inverter and disconnect it from the AC power source.
2. Lever the fan holder off the drive frame with a screwdriver and lift the fan holder.
3. Free the fan cable from the clip.
4. Disconnect the fan cable.
5. Remove the fan holder.
6. Install the new fan holder including the fan in reverse order.
7. Connect the power supply.

## 10.3 Capacitors

### 10.3.1 Reforming the capacitors

The DC bus capacitors must be reformed according to the operation instruction if the inverter has been stored for a long time. The storing time is counted from the the delivery date.

Time	Operational principle
Storing time less than 1 year	Operation without charging
Storing time 1-2 years	Connect with the power for 1 hour before first ON command
Storing time 2-3 years	Use power surge to charge for the inverter <ul style="list-style-type: none"> <li>• Add 25% rated voltage for 30 minutes</li> <li>• Add 50% rated voltage for 30 minutes</li> <li>• Add 75% rated voltage for 30 minutes</li> <li>• Add 100% rated voltage for 30 minutes</li> </ul>
Storing time more than 3 years	Use power surge to charge for the inverter <ul style="list-style-type: none"> <li>• Add 25% rated voltage for 2 hours</li> <li>• Add 50% rated voltage for 2 hours</li> <li>• Add 75% rated voltage for 2 hours</li> <li>• Add 100% rated voltage for 2 hours</li> </ul>

The method of using power surge to charge for the inverter:

The right selection of power surge depends on the supply power of the inverter. Single phase 220V AC/2A power surge applied to the inverter with single/three-phase 220V AC as its input voltage. The inverter with single/three-phase 220V AC as its input voltage can apply single phase 220V AC/2A power surge. All DC bus capacitors charge at the same time because there is one rectifier. High-voltage inverter needs enough voltage (for example, 400V) during charging. The small capacitor power (2A is enough) can be used because the capacitor nearly does not need current when charging.

The operation method of inverter charging through resistors (LEDs):

The charging time is at least 60 minutes if charge the DC bus capacitor directly through supply power. This operation is available on normal temperature and no-load condition and the resistor should be serially connected in the 3-phase circuits of the power supply:

400V driven device: 1kΩ/100W resistor. LED of 100W can be used when the power voltage is no more than 400V. But if used, the light may be off or weak during charging.

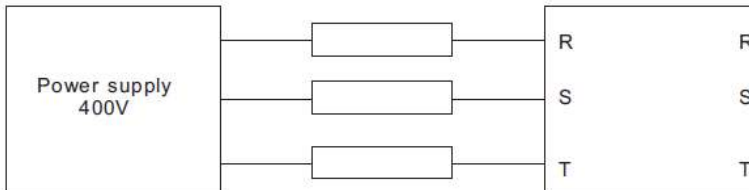

Figure 10-1 400V charging illustration of the driven device

### 10.3.2 Change electrolytic capacitors



- ◆ Read and follow the instructions in chapter **Safety Precautions**. Ignoring the instructions may cause physical injury or death, or damage to the equipment.

Change electrolytic capacitors if the working hours of electrolytic capacitors in the inverter are above 35000. Please contact with the local INVT offices or dial our national service hotline (400-700-9997) for detailed operation.

### 10.4 Power cable







- ◆ Read and follow the instructions in chapter **Safety Precautions**. Ignoring the instructions may cause physical injury or death, or damage to the equipment.







1. Stop the drive and disconnect it from the power line. Wait for 10 minutes to make DC capacitor discharge. Measure with a multimeter (impedance at least 1MΩ) to ensure the capacitor is discharged.
2. Check the tightness of the power cable connections.
3. Connect the power supply.



## Chapter 11 Fault code

No.	Fault code of controller	Fault code of LED	Fault instruction	Fault reason	Solution	Method
1	1	1	Main control board fault	Internal fault	Replace the main control board	Stop immediately
2	2	2	Power fault of IO board	1.Power damage (external DC 24V) or offline 2.Cable disconnection	1.Check the cable connection between IO board and master 2.Check the power supply (24V)	Stop immediately; fault reset automatically
3	5	5	No pulse feedback	1.DSP communication fault 2.Corresponding speed is 0	1.Replace the main control board; 2.Modify the parameter	Stop immediately; fault reset automatically
4	6	6	Pulse reversion	1.Pulse direction parameters fault 2.Running direction of the elevator reverses 3.Elevator sliding down	1.Modify the parameter and counting direction 2.Set load compensation 3.Reautotuning of the master	Stop immediately; fault reset automatically
5	9	9	Thermal protection	Thermal protection	1.Check logic and connection of input point 2.Improve motor cooling	Preferred stopping, fault reset delay





6	11		Car communication fault	No communication or communication overtime between the main controller and the car control board or the car top board	<ol style="list-style-type: none"> <li>1. Check the communication cable circuit and plug-ins.</li> <li>2. Check the power supply (DC24V).</li> <li>3. Check the communication protocol</li> <li>4. Set IC card baud rate incorrectly</li> </ol>	Preferred stopping, fault reset automatically
8	30		Safety circuit breaking	<ol style="list-style-type: none"> <li>1. Safety circuit disconnection</li> <li>2. Damage to the contact of the relay</li> <li>3. Abnormal high-voltage detection</li> </ol>	<ol style="list-style-type: none"> <li>1. Check the safety circuit</li> <li>2. Replace the contactor of the safety circuit or change the IO board</li> <li>3. Check the high-voltage circuit</li> </ol>	Stop immediately; fault reset automatically
9	31		Lock open in running	<ol style="list-style-type: none"> <li>1. Misadjustment of the position of the door knife</li> <li>2. Bad connection of the contact of the door lock</li> <li>3. Bad connection of the car lock or hall lock</li> </ol>	<ol style="list-style-type: none"> <li>1. Adjust the door lock</li> <li>2. Replace the contactor of the door lock</li> <li>3. Check the circuit of the door lock</li> </ol>	Stop immediately; fault reset automatically
10	32		Short circuit fault of door lock	1. The lock signal and opening signal act at the same time	<ol style="list-style-type: none"> <li>1. Check the short circuit of the door lock</li> <li>2. Check the</li> </ol>	Stop; fault reset automatically

				2.After the opening signal output for 5s, the lock still does not disconnect	misaction of the switch 3.Check the door operator	
11	33		Do not stop at the door area	Elevator protection caused by other faults	Analyze with other faults	Fault tips
12	34		DEC overtime	The deceleration time exceeds the time calculated in the parameter	1.Sliding of the elevator rope 2.Wrong parameters setting	Stop immediately; reset automatically
13	35		Single floor running overtime fault	1.Signal loss in the door area 2.Motor stall or car blocked 3.Too high floor	1.Check the signal in door area 2.Check the tractor 3. Wrong parameters setting	Stop immediately; fault reset manually
14	37		Whole running overtime fault	1.Signal loss in the door area 2.Motor stall or car blocked 3.For deceleration	1.Check the signal in door area 2.Check the tractor 3. Wrong parameters setting	Stop immediately; fault reset manually
15	40		Abnormal signal in door area	Keep in the door area after start quickly for 5s	1.Check the braking device is open 2.Check the switch in door area	Stop immediately; fault reset manually
16	42		Forced DEC switch of the bottom and top floor act at the same	Forced deceleration switch of the bottom and top floor act at the	1.Check the forced switch is damaged or offline 2.Check the corresponding	Stop immediately; fault reset automatically

			time	same time	logic setting	
17	43	43	Earthquake action	The main board detects the earthquake	1.Check the corresponding logic setting 2.Corresponding detection point damage	Function tips
18	46	46	Abnormal elevator speed	The running speed of the elevator exceeds 115% of the rated speed	1.Check the speed feedback of the encoder 2.Check the parameters setting	Stop immediately; fault reset automatically
19	47	47	Lower limit switch action	Lower limit switch action	1.Check the installation position of the lower limit switch 2.Check the corresponding logic setting 3.Check the switch wiring	Stop immediately; fault reset automatically
20	48	48	Upper limit switch action	Upper limit switch action	1.Check the installation position of the upper limit switch and connection 2.Check the corresponding logic setting	Stop immediately; fault reset automatically
21	50	50	Overtime of the running contactor closing	No feedback after the running contactor closing	1.Replace the contactor 2.Check the external wiring 3.Check the corresponding	Stop immediately; fault reset automatically





					logic setting	
22	51	51	Overtime of the running contactor opening	Feedback after the running contactor releasing	1.Replace the contactor 2.Check the external wiring 3.Check the corresponding logic setting	Stop immediately; fault reset automatically
23	52	52	Overtime of the brake contactor closing	No feedback after the brake contactor closing	1.Replace the contactor 2.Check the external wiring 3.Check the corresponding logic setting	Stop immediately; fault reset automatically
24	53	53	Overtime of the brake contactor opening	Feedback after the brake contactor releasing	1.Replace the contactor 2.Check the external wiring 3.Check the corresponding logic setting	Stop immediately; fault reset automatically
25	54	54	Brake travel action overtime	1.The brake does not open totally when the elevator starts 2.The brake travel switch is not installed properly 3.The brake opens slowly 4.The MF input is set to dual brake by accident	1.Adjust the position 2.Adjust braking gap 3.The brake travel switch does not contact well. When the brake travel switch is no installed, short circuit to the detection point of brake contactor	Stop immediately; fault reset automatically



					4.Check the corresponding logic setting 5. Check the definition of MF input	
26	55	55	Brake travel reset overtime	1.The brake does not close totally when the elevator stops 2.The brake travel switch is not installed properly 3.The brake opens slowly 4.The MF input is set to dual brake by accident	1.Adjust the position 2.Adjust braking gap 3.The brake travel switch does not contact well 4.Check the corresponding logic setting	Stop immediately; fault reset automatically
27	56	56	UPS output relay closing overtime	No feedback after UPS switching	1.Check peripheral wiring 2.Check UPS output relay	Prohibit UPS back leveling; fault reset and exit UPS automatically
28	57	57	Star-delta contactor closing overtime	1.No feedback after the elevator starts 2.Set MF input to star-delta independent output by accident	1.Check peripheral wiring 2.Check the corresponding logic setting 3.Check the definition of MF input	Prohibit the elevator starting; fault reset automatically

29	58		Hardware enabling adhesion	No detection of the signal after the elevator starts	1.Check the connection cables of the IO board 2.Check the contactor and connection	Stop immediately; fault reset automatically
30	59		Star-delta contactor opening overtime	1.Detection of the signal after the elevator stops 2.Set MF input to star-delta independent output by accident	1.Check peripheral wiring 2.Check the corresponding logic setting 3.Check the definition of MF input	Prohibit the elevator starting; fault reset automatically
31	60		Opening fault	No detection of the signal after opening for 20s	1.Clean the sill of the door operator 2.Enlarge the low speed torque of the door operator 3.Check the corresponding logic setting	Fault tips
32	61		Closing fault	No detection of the signal after closing for 10s	1.Clean the sill of the door operator 2.Enlarge the low speed torque of the door operator 3.Check the corresponding logic setting	Fault tips
33	62		Door closed/door open act at the same	Limit switch of door closed/open act at the same time	1.Limit switch damage 2.Check the corresponding	Stop immediately; fault reset automatically

			time		logic setting	
34	64	64	Safety touch pad/beam action overtime	Safety touch pad/continuous action of beam overtime	1.Human obstruction 2.Detection point damage, disconnection or short circuit 3.Check the corresponding logic setting	Fault tips
35	65	65	Auto aid	The detection of auto aid signal by the main board	1.Check the corresponding logic setting 2.Corresponding detection point damage	Function tips
36	66	66	Door lock block when door closed	Door lock block when door closed	1.Adjust the digital position of the door operator 2.Exchange lock device 3.Check the corresponding logic setting	Stop immediately; fault reset automatically
37	70	70	UP/DOWN slow limit switch act at the same time	UP/DOWN slow limit switch act at the same time	1.Switch damage or disconnection 2.Check the corresponding logic setting	Stop immediately; fault reset automatically
38	71	71	UP/DOWN speed forced DEC switches act at the same time	The forced deceleration switches act at the same time	1.Switch damage or disconnection 2.Check the corresponding logic setting	Emergency deceleration to stop; fault reset automatically











39	72		DOWN low speed forced DEC switch adhesion	DOWN low and medium speed forced deceleration switches do not reset when the elevator leaves the ground floor for 9s	1.Switch damage or disconnection 2.Check the speed or DEC/ACC curve setting	Preferred leveling; fault reset automatically
40	73		UP low speed forced DEC switch adhesion	UP low and medium speed forced deceleration switches do not reset when the elevator leaves the ground floor for 9s	1.Switch damage or disconnection 2.Check the speed or DEC/ACC curve setting	Preferred leveling; fault reset automatically
41	74		DOWN /MEDIUM speed forced DEC switch adhesion	DOWN/MEDIUM speed forced deceleration switch does not reset when the elevator leaves ground floor for 9s	Switch damage or disconnection	Preferred leveling; fault reset automatically
42	75		UP/MEDIUM speed forced DEC switch adhesion	UP/MEDIUM speed forced deceleration switch does not reset when the elevator leaves ground floor for 9s	Switch damage or disconnection	Preferred leveling; fault reset automatically





43	76		Forced DEC switch faulty action	Up forced deceleration switch faulty action when the elevator goes up; down forced deceleration switch faulty action when the elevator goes down	Switch damage or disconnection	Emergency deceleration to leveling; fault reset automatically
44	77		Terminal overspeed running	When the elevator runs to the terminal and the forced deceleration switch acts, the speed exceeds the corresponding speed of the switch	Switch damage or disconnection	Stop immediately; fault reset manually
45	79		Abnormal elevator position	1.The elevator is in the terminal station, but the corresponding low speed forced deceleration switch does not act 2.The corresponding low speed forced deceleration switch acts, but	1.Disconnection or short circuit of the low speed forced deceleration switch 2.High speed counting pulse and door area signal loss 3.Check the wire rope 4.Check the corresponding	Preferred leveling, fault reset automatically







				the elevator is in the terminal station 3.Information loss of the hoistway 4.Floor error	logic setting 5.The position of the forced deceleration switch changed after hoistway autotuning	
46	82	82	Contactors adhesion fault exceeds the setting	No. 50, 51, 52, 53, 54, 55, 57, 59 fault more than 5 times	Replace the corresponding contactor	Stop immediately; fault reset after power off
47	83	83	Fault of drive unit exceeds the setting value	Drive unit fault exceeds the value of P5.07		Stop immediately; fault reset after power off
48	84	84	Main board error		Contact with the manufacturer	Unable to run
49	89	89	Maintenance switch action in running	Manual maintenance action or bad connection of the maintenance switch	Check the switch and circuit	Stop immediately
50	101	A1	Inverter unit U phase protection	1.The output of the main circuit is grounded or	1.Check the external problems such as the connection	Stop immediately; fault restore, fault reset when power off
51	102	A2	Inverter unit V phase protection	short circuited 2.Too long connection wires	2.Install the reactor or output	

52	103	A3	Inverter unit W phase protection	of the tractor 3.Internal damage to IGBT 4.Internal connection of the controller is loose	filter 3.Contact with the manufacturer 4.Check the internal problems such as connection	
53	104	A4	ACC overcurrent	1.The output of the main circuit is grounded or short circuited 2.Wrong parameters setting of the name plate of the master 3.Too large load 4.Wrong encoder signal 5.ACC/DEC curve is too swift	1.Check the parameters of the master 2.Check the encoder feedback 3.Adjust S curve 4.Reautotuning of the motor 5.Check the brake is open totally 6.Check the synchronous master adhesion 7.Check the mechanical stuck 8.Check the balance coefficient	Stop immediately; fault reset automatically
54	105	A5	DEC overcurrent			
55	106	A6	Constant speed overcurrent			
56	107	A7	ACC overvoltage	1.Too high input voltage 2.Serious counter EMF of the tractor	1.Check the bus voltage 2.Check the balance coefficient	Stop immediately; fault reset automatically
57	108	A8	DEC overvoltage	3.Large braking resistor or abnormal	3.Select suitable braking resistor 4.Check the connection of the	



58	109		Constant speed over voltage	braking unit 4. ACC/DEC curve is too swift	braking resistor 5.Adjust S curve	
59	110		Under-voltage fault	1.Sudden power off 2.Too low input voltage 3.Abnormal drive control board	1.Check the external power supply and whether the power is off when the motor is running 2.Check the contacting layer of the input power supply 3.Contact with the manufacturer	Stop immediately; fault reset automatically
60	111		Motor overload	1.Wrong parameters setting 2.Abnormal braking circuit 3.Too heavy load	1.Adjust the parameters 2.Check the braking circuit	Stop immediately; fault reset automatically
61	112		System overload	1. Abnormal braking circuit 2.Too large load 3.Check the encoder feedback signal 4.Check the parameters of the master 5.Check the power cable of the master	1.Check the braking circuit and braking devices 2.Reduce the load 3.Check the feedback signal of the encoder and the original angle of the encoder 4.Check the parameter setting of the name plate of the master	Stop immediately; fault reset automatically

					5.Check the power cable of the master	
62	113		Phase loss in input side	1.Asymmetrical input power 2.Abnormal drive control board	1.Set through the parameters 2.Check the 3 phase power supply in input side and the power voltage 3.Contact with the manufacturer	Stop immediately; fault reset automatically
63	114		Phase loss in output side	1.Loose connection of the output of the main circuit 2.Damage to the master	1.Check the contactor in input side 2.Solve the master fault	Stop immediately; fault reset automatically
64	115		Overheat of the rectification module	1.Sudden overcurrent 2.Output grounding short circuit 3.Air duct block or damage 4.Environment temperature is too high	1.Refer to the overcurrent measurement 2.Reconfigure 3.Dredge the air duct or change the fan 4.Reduce the temperature	Stop immediately; fault reset automatically
65	116		Overheat of the converting module	5.Control board or plug-in loose 6.Abnormal main board or damage to the sensor	5.Contact with the manufacturer	

66	118		485 communica- tion fault		Check the parameters setting	Fault tips
67	119		Current detection fault	<ol style="list-style-type: none"> <li>1.Bad connection of the control board</li> <li>2.Auxiliary power damage</li> <li>3.Hall device damage</li> <li>4.Amplifying circuit abnormal</li> <li>5.No enabling of the drive module</li> </ol>	<ol style="list-style-type: none"> <li>1.Check the cable of the main board and the drive board</li> <li>2.Replace the main board or main control board</li> <li>3.Check the main board</li> </ol>	Stop immediately; fault reset automatically
68	120		Autotuning fault of the motor	<ol style="list-style-type: none"> <li>1.Wrong setting of the autotuning static current of the master</li> <li>2.Wrong parameters setting</li> <li>3.The capacity does not match that of the drive board</li> <li>4.The running contactor does not close</li> </ol>	<ol style="list-style-type: none"> <li>1.Adjust the autotuning static identification current</li> <li>2.Set the rated parameters according to the name plate of the motor</li> <li>3.Check the motor connection</li> <li>4.Change the drive board</li> </ol>	Stop immediately; fault reset automatically
69	121		Encoder offline	<ol style="list-style-type: none"> <li>1.Encoder damage or offline</li> <li>2.Too short time for offline detection</li> </ol>	<ol style="list-style-type: none"> <li>1.Check the encoder and the connection</li> <li>2.Check the braking</li> <li>3.Check the</li> </ol>	Stop immediately; fault reset automatically

					speed setting	
70	122		Encoder reversion	1.Signal wires reverse 2.Too short time for reverse detection	1.Serious sliding 2.Change the direction of the encoder and reautotuning of the master	Stop immediately; fault reset automatically
71	125		Fault of magnetic pole position detection	Abnormal magnetic pole position detection of the synchronous master	Change the direction of the encoder and reautotuning of the master	Unable to run
72	126		Braking circuit fault	1.Damage to the braking circuit or braking pipes 2.Low external braking resistance	1.Check the braking unit 2.Replace new braking pipe 3.Increase the braking resistance	Stop immediately; fault reset automatically
73	131		CPU abnormal	CPU communication overtime	1.Restart after the power off in the system 2.Replace the main controller	Stop immediately; fault reset automatically
74	132		Excessive speed deviation	1. Excessive rotating speed deviation 2.Running fast 3.Over adjustment of the system	1.Check the encoder and the connection 2.Add the gain 3.Reautotuning of the master	Stop immediately; fault reset automatically
75	137		With running signal, but without hardware	1.Disconnection of the hardware enabling wires 2.Damage to the	1.Check the circuit and the connection 2.Check the	Stop immediately; fault reset automatically





















			enabling signal	contact of the running contactor	contact of the contactor	
76	138		Motor short circuit to the ground software fault	1.Damage to the motor wires, contact with the shell 2. Motor insulation damage, contact with the shell	1.Check the motor connection 2.Check the motor insulation	Stop immediately; fault restore, fault reset when power off
77	139		Motor short circuit to the ground hardware fault	1.Damage to the motor wires, contact with the shell 2. Motor insulation damage, contact with the shell	1.Check the motor connection 2.Check the motor insulation	Stop immediately; fault restore, fault reset when power off

## Chapter 12 Appendix

### 12.1 10-2-16 binary table

Decimal	Binary	Hexadecimal
0	0000	0
1	0001	1
2	0010	2
3	0011	3
4	0100	4
5	0101	5
6	0110	6
7	0111	7
8	1000	8
9	1001	9
10	1010	A
11	1011	B
12	1100	C
13	1101	D
14	1110	E
15	1111	F

### 12.2 Definition table

Displayed						
Meaning	0	1	2	3	4	5
Displayed						
Meaning	6	7	8	9	A	B
Displayed						
Meaning	C	D	E	F	H	L



Tel:+86-510-68918899 Fax:+86-510-68918898 Website:[www.invt-elevator.com](http://www.invt-elevator.com)

Building 2,Xingzhou Science&Technology Business Park,No.89 Xingchuang Rd,WND,Wuxi,Jiangsu,China

Industrial Automation:  Frequency Inverter

Intelligent Elevator Control System



66001-00241

INVT Copyright.

Information may be subject to change without notice during product improving.

201803 (V1.2)